

freud

Precisely
the best



Fræseværktøjer til håndholdte fræsere, bordfræsere og CNC-maskiner

BREDT UDVALG AF FØRSTEKLASSES KVALITETSFRÆSEJERN

Notfræsere		Freuds notfræsere i alle relevante skaftdiametre og med skærediametre på op til 25 mm. Designet til at opnå rene og præcise resultater ved mange anvendelser.
Afgratningsfræsere		Freuds udvalg af afgratningsfræsere til præcis afgratning af laminat eller finerbelagte arbejdsborde. Til arbejde med stiksåve, til fremstilling eller gentagelse af detaljkrævende former eller til enhver opgave, som kræver et rent snit langs en flugtende kant.
Kantfræsere		Freuds kantfræsere til profileringsanvendelser såsom afrunding, affasning og meget mere.
Samlingsfræsere		Freuds samlingsfræsere, som omfatter alt fra notskærere til svalehalefræsere, er designet til at lave perfekte træsamlinger.
Overfladefræsere		Freuds overfladefræsere sikrer en perfekt profilrille på træoverflader.
Blandede sæt		Blandende fræsejern er tilgængelige med de mest almindelige skaftdiametre, ligesom vi også tilbyder vores klassiske skabsdørsæt.

Ikon-guide

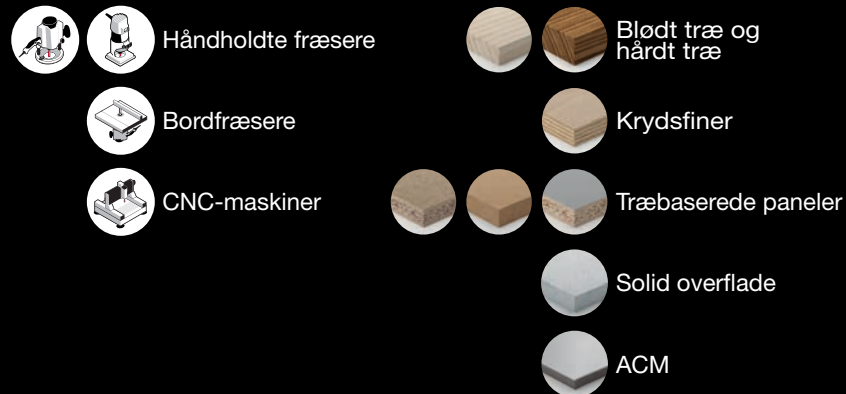



Lang standtid

Brugertilpassede skær fremstillet af ekstra holdbare og hårde karbidkorn fra in-house-udvikling og produktion.



Skærevinkelteknologi

Hårdmetalbestykkede skærevinkler er optimeret til at levere en fremragende ydelse og finish.



TiCo-hårdmetal

- En specialformuleret og yderst kompakt titanium koboltkarbid, som er udviklet og designet af Freud.
- Den tilbyder en skarpere kant og en perfekt finish med betydelig længere skærestandtid.



Perma-SHIELD-belægning

- En ikke-klæbende belægningsformulering som modstår selv de mest krævende anvendelser.
- Den giver termisk isolering, beskytter mod korrosion og eliminerer ophobning af resin, hvilket mindsker nedetid i forbindelse med rengøring.



Kugleleje

Kugleleje af høj kvalitet er designet til høje hastigheder. Beskyttet mod støv for ekstra lang standtid.



Belægningsteknologi

Brancheinnovativ belægning beskytter fræsebit imod friktion, rust, ophobning af resin og korrosion, hvilket forlænger standtiden.

Ekstremt stødresistent

Avancerede loddeprocesser sikrer den største fleksibilitet og slagresistens til hver profil.



EN SPECIALLØSNING TIL SAMLINGER



Velegnet til bordfræsning



Velegnet til træ og omdannelsesprodukter



A	Maks. omdr./min.	Freud-kode	Art.nr.
12	16.000	99-03612P	F03FR02432

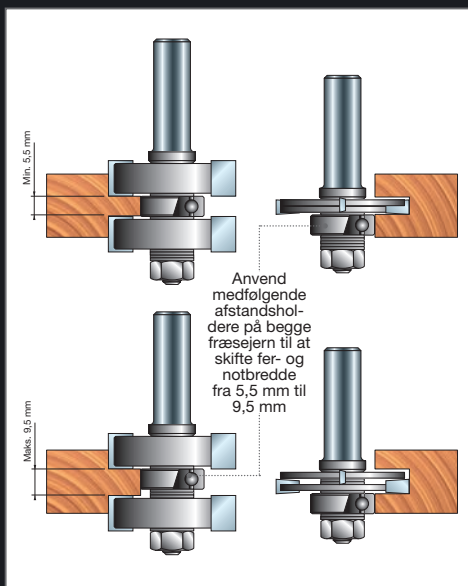

- Det justerbare fer- og notskærersæt er løsningen til projekter, som kræver præcis fer- og notsamlinger med perfekt finish.
- Sættet inkluderer en fer- og en notfræser.



NOTFRÆSERE

Notfræser med dobbelt skær 04- 12- MM- R006M

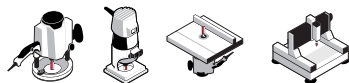

Type A - Hårdmetalfærsere

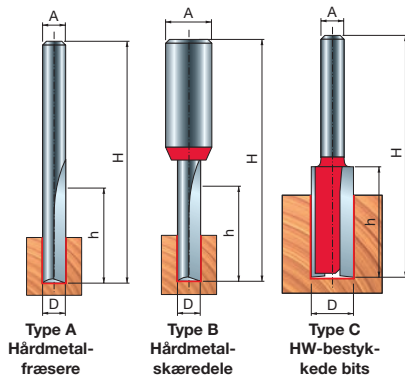

D	h	H	A	Z	Maks. omdr./min.	Freud-kode	Art.nr.
mm	mm	mm	mm	tomme	1/min.		
2	6,3	44,5	6	2	24.000	04-09706P	F03FR01413
3	9,5	44,5	6	2	24.000	04-09906P	F03FR01415
3	11	50,8	6	2	24.000	04-10006P	F03FR01418
3	12	50	6	2	24.000	R006M03006	F03FR01355
4	12	50,3	6	2	24.000	R006M05006	F03FR01356
4	12	50,8	6	2	24.000	04-10206P	F03FR01423
4	15,8	50,7	6	2	24.000	04-10106P	F03FR01420
5	12	50,3	6	2	24.000	R006M07006	F03FR01357
5	12,7	50,8	6	2	24.000	04-11306P	F03FR01437
5	16	51	6	2	24.000	R006M07406	F03FR01358

D	h	H	A	Z	Maks. omdr./min.	Freud-kode	Art.nr.
mm	mm	mm	mm	tomme	1/min.		
6	16	50,8	6	2	24.000	04-11406P	F03FR01440
6	16	57	6	2	24.000	R006M09406	F03FR01359
6	25	63	6	2	24.000	R006M10206	F03FR01360
6	25,4	76,2	6	2	24.000	04-11006P	F03FR01431
3	9,5	44,5	8	2	24.000	04-09908P	F03FR01416
4	15,8	50,7	8	2	24.000	04-10108P	F03FR01421
5	12,7	50,8	8	2	24.000	04-11308P	F03FR01438
6	16	50,8	8	2	24.000	04-11408P	F03FR01441
6	25,4	76,2	8	2	24.000	04-11008P	F03FR01432
1,58	6,4	44,5	1/4	2	24.000	04-09625P	F03FR01412
2	4	38,1	1/4	2	24.000	04-50225P	F03FR01502
2,38	9,5	38,1	1/4	2	24.000	04-09825P	F03FR01414
3	8	44,5	1/4	2	24.000	04-50825P	F03FR01503
3,18	9,5	44,5	1/4	2	24.000	04-10025P	F03FR01419
4	15,77	50,8	1/4	2	24.000	04-10125P	F03FR01422
4,76	12,7	49,2	1/4	2	24.000	04-10225P	F03FR01424
5	11,9	50,8	1/4	2	24.000	04-51225P	F03FR01504
6,35	12,7	50,5	1/4	2	24.000	04-10425P	F03FR01426
6,35	15,9	50,8	1/4	2	24.000	04-10525P	F03FR01427
6,35	19	57,1	1/4	2	24.000	04-10625P	F03FR01428
6,35	22,2	57,1	1/4	2	24.000	04-10725P	F03FR01429
6,35	25,4	63,5	1/4	2	24.000	04-10825P	F03FR01430
6,35	25,4	76,2	1/4	2	24.000	04-11025P	F03FR01433
6,35	19	61	1/2	2	24.000	12-10050P	F03FR01521
6,35	23	73	1/2	2	24.000	12-10250P	F03FR01522

Type B - hårdmetalskæredede

D	h	H	A	Z	Maks. omdr./min.	Freud-kode	Art.nr.
mm	mm	mm	mm		1/min.		
3	8	58	12	2	24.000	12-09612P	F03FR01517
4	10	58	12	2	24.000	12-09712P	F03FR01518
5	12,7	57	12	2	24.000	12-09812P	F03FR01519
6	19	64	12	2	24.000	12-09912P	F03FR01520

Type C - HW-bestykkede fræsere

D	h	H	A	Z	Maks. omdr./min.	Freud-kode	Art.nr.
mm	mm	mm	mm	tomme	1/min.		
7	25,4	63,5	6	2	24.000	04-11206P	F03FR01434
8	19,1	52	6	2	24.000	04-11506P	F03FR01443
8	31,8	70	6	2	24.000	04-11906P	F03FR01447
9	25	63	6	2	24.000	04-12406P	F03FR01450
10	25,4	62,4	6	2	24.000	MM-01006P	F03FR00330
10	31,8	69	6	2	24.000	MM-11006P	F03FR00333
11	25,4	62	6	2	24.000	04-13306P	F03FR01458

D	h	H	A	Z	Maks. omdr./min.	Freud-kode	Art.nr.
mm	mm	mm	mm	tomme	1/min.		
12	19	55,5	6	2	24.000	04-13506P	F03FR01460
12	31,8	68	6	2	24.000	04-13706P	F03FR01464
13	25,4	62,4	6	2	24.000	04-14206P	F03FR01470
14	19	56	6	2	24.000	04-14306P	F03FR01472
14	31,8	68,2	6	2	24.000	04-14506P	F03FR01475
15	20	57,2	6	2	24.000	04-14606P	F03FR01478
15	31,8	68,2	6	2	24.000	04-14706P	F03FR01480
16	19	51	6	2	24.000	04-14906P	F03FR01483
16	31,8	66	6	2	24.000	04-15006P	F03FR01486
18	20	52	6	2	24.000	04-15106P	F03FR01488
19	19	54	6	2	24.000	04-14006P	F03FR01468
20	19	56	6	2	24.000	04-15506P	F03FR01492
22	19	51	6	2	24.000	04-15706P	F03FR01495
24	20	52	6	2	24.000	04-15806P	F03FR01498
25	19	56	6	2	24.000	04-15906P	F03FR01500
7	25,4	63,5	8	2	24.000	04-11208P	F03FR01435
8	19	52	8	2	24.000	04-11508P	F03FR01444
8	31,8	70	8	2	24.000	04-11908P	F03FR01448
9	25	63	8	2	24.000	04-12408P	F03FR01451
10	25,4	62,4	8	2	24.000	MM-01008P	F03FR00331
10	31,8	69	8	2	24.000	MM-11008P	F03FR00334
12	19	55,5	8	2	24.000	04-13508P	F03FR01461
12	31,8	63,8	8	2	24.000	04-13708P	F03FR01465
14	19	56	8	2	24.000	04-14308P	F03FR01473
14	31,8	68,2	8	2	24.000	04-14508P	F03FR01476
15	20	57,2	8	2	24.000	04-14608P	F03FR01479
15	31,8	68,2	8	2	24.000	04-14708P	F03FR01481
16	19	51	8	2	24.000	04-14908P	F03FR01484
16	31,8	66	8	2	24.000	04-15008P	F03FR01487
18	20	52	8	2	24.000	04-15108P	F03FR01489
20	19	56	8	2	24.000	04-15508P	F03FR01493
22	19	51	8	2	24.000	04-15708P	F03FR01496
24	20	52	8	2	24.000	04-15808P	F03FR01499
25	19	56	8	2	24.000	04-15908P	F03FR01501
7	18	67	12	2	24.000	12-10312P	F03FR01523
8	31,8	76	12	2	24.000	12-10712P	F03FR01525
9	31,8	76	12	2	24.000	12-11012P	F03FR01528
10	31,8	76	12	2	24.000	12-11212P	F03FR01530
12	38,1	80	12	2	24.000	12-12212P	F03FR01534
12	50,5	98	12	2	24.000	12-12812P	F03FR01537
13	25,4	66,7	12	2	24.000	12-11612P	F03FR01531
14	31,8	73	12	2	24.000	12-13412P	F03FR01540
15	31,8	69,8	12	2	24.000	12-13512P	F03FR01541
16	38,1	76,1	12	2	24.000	12-14012P	F03FR01544
18	38,1	80	12	2	24.000	12-14312P	F03FR01547
19	25,4	63,4	12	2	24.000	12-15212P	F03FR01548
20	38,1	80	12	2	24.000	12-15912P	F03FR01553
22	38,1	80	12	2	24.000	12-16912P	F03FR01556

D	h	H	A	Z	Maks. omdr./min.	Freud-kode	Art.nr.	
mm	mm	mm	mm	tomme	1/min.			
7,14	25,4	65,4		1/4	2	24.000	04-11225P	F03FR01436
7,94	25,4	71,4		1/4	2	24.000	04-11825P	F03FR01446
9,53	22,2	59,2		1/4	2	24.000	04-12025P	F03FR01449
9,53	25,4	62,4		1/4	2	24.000	04-12425P	F03FR01452
9,53	31,8	68,7		1/4	2	24.000	04-12625P	F03FR01453
10	25,4	62,4		1/4	2	24.000	MM-01025P	F03FR00332
10	31,8	63,8		1/4	2	24.000	04-52025P	F03FR01505
11,11	25,4	62,4		1/4	2	24.000	04-12925P	F03FR01454
12	31,8	63,8		1/4	2	24.000	04-52825P	F03FR01506
12,7	19	55,5		1/4	2	24.000	04-13025P	F03FR01455
12,7	22,2	59,2		1/4	2	24.000	04-13125P	F03FR01456
12,7	25,4	62,4		1/4	2	24.000	04-13225P	F03FR01457
12,7	31,8	69,9		1/4	2	24.000	04-13325P	F03FR01459
15	31,8	66,7		1/4	2	24.000	04-53625P	F03FR01507
15,88	19	51		1/4	2	24.000	04-13625P	F03FR01463
15,88	31,8	69,9		1/4	2	24.000	04-13725P	F03FR01466
16	31,8	66,7		1/4	2	24.000	04-54425P	F03FR01508
17,46	19,1	56,1		1/4	2	24.000	04-13825P	F03FR01467
18	19,1	51,1		1/4	2	24.000	04-54825P	F03FR01509
19	19	57		1/4	2	24.000	04-14025P	F03FR01469
20	19,1	51,1		1/4	2	24.000	04-55225P	F03FR01510
22,23	19,1	56,1		1/4	2	24.000	04-14825P	F03FR01482
25,4	19,1	56,1		1/4	2	24.000	04-15225P	F03FR01491
7,94	25,4	78,9		1/2	2	24.000	12-10650P	F03FR01524
9,53	25,4	73,6		1/2	2	24.000	12-10850P	F03FR01526
9,53	31,8	82		1/2	2	24.000	12-11050P	F03FR01529
10	31,8	75		1/2	2	24.000	12-52050P	F03FR01558
12	31,8	75		1/2	2	24.000	12-53050P	F03FR01559
12,7	25,4	66,7		1/2	2	24.000	12-11650P	F03FR01532
12,7	31,8	77		1/2	2	24.000	12-11850P	F03FR01533
12,7	38,1	80,4		1/2	2	24.000	12-12250P	F03FR01535
12,7	38,1	108		1/2	2	24.000	12-12450P	F03FR01536
12,7	50,5	98		1/2	2	24.000	12-12850P	F03FR01538
12,7	63,2	110,7		1/2	2	24.000	12-13050P	F03FR01539
15,88	25,4	62,4		1/2	2	24.000	12-13650P	F03FR01542
15,88	31,8	71,8		1/2	2	24.000	12-13850P	F03FR01543
15,88	38,1	76,1		1/2	2	24.000	12-14050P	F03FR01545
15,88	50,8	103		1/2	2	24.000	12-14250P	F03FR01546
16	31,8	69,8		1/2	2	24.000	12-54450P	F03FR01560
19	25,4	63,4		1/2	2	24.000	12-15250P	F03FR01549
19	31,8	69,8		1/2	2	24.000	12-15450P	F03FR01550
19	38,1	76,1		1/2	2	24.000	12-15650P	F03FR01551
19,05	50,8	88,8		1/2	2	24.000	12-15850P	F03FR01552
20,63	31,8	76		1/2	2	24.000	12-16250P	F03FR01554
22,23	31,8	76		1/2	2	24.000	12-16850P	F03FR01555
25,4	31,8	69,8		1/2	2	24.000	12-17250P	F03FR01557

Køkken monteringsæt 88-

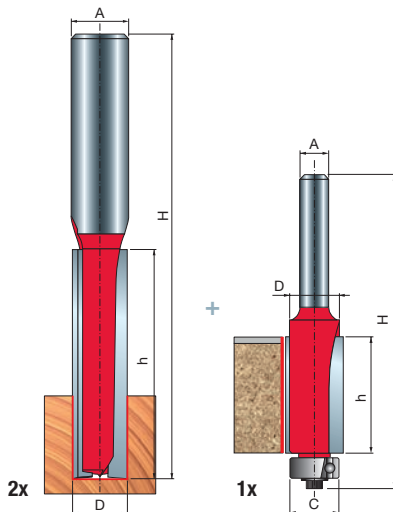
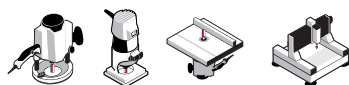

	A	Maks. omdr./min.	Freud-kode	Art.nr.
	tomme	1/min.		
2x Notfræser og 1x flush afgratningsfræsesæt	1/2 1/4	24.000	88-20075P	F03FR04370

Notfræser med dobbeltskær og bundskær 17-

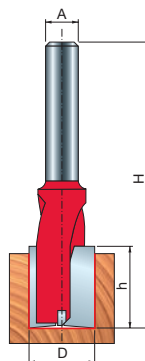
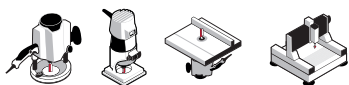

D	h	H	A	Z	Maks. omdr./min.	Freud-kode	Art.nr.
mm	mm	mm	mm		1/min.		
16	45	85	8	2+1	24.000	17-10008P	F03FR01577
18	18	70	8	2+1	24.000	17-10208P	F03FR01578
20	18	70	8	2+1	24.000	17-10408P	F03FR01579
22	25	70	8	2+1	24.000	17-10608P	F03FR01580
16	60	110	12	2+1	24.000	17-10112P	F03FA13994

Forskydningsfræser

14-

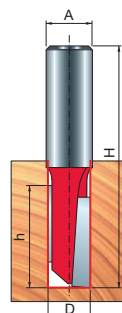
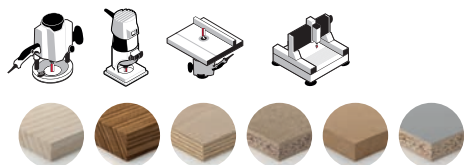

D	h	H	A	Z	Maks. omdr./min.	Freud-kode	Art.nr.
mm	mm	mm	mm		1/min.		
9,53	37,8	82	12	2	24.000	14-1021P	F03FR01561
12,7	38,1	82	12	2	24.000	14-1041P	F03FR01562
12,7	37,8	79	12	2	24.000	14-2041P	F03FR01564
12,7	54	98,3	12	2	24.000	14-1061P	F03FR01563

Mortisingsfræser

16-

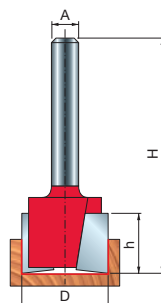
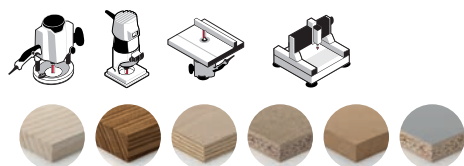

D	h	H	A	Z	Maks. omdr./min.	Freud-kode	Art.nr.	
mm	mm	mm	mm	tomme	1/min.			
12,7	12,5	51	6	2	24.000	16-10006P	F03FR01565	
19	12,5	51	6	2	24.000	16-10406P	F03FR01568	
19	19	62,15	6	2	24.000	16-50406P	F03FR01576	
12,7	12,5	50,8	8	2	24.000	16-10008P	F03FR01566	
19	12,5	50,8	8	2	24.000	16-10408P	F03FR01569	
12,7	12,5	60,5	12	2	24.000	16-11012P	F03FR01573	
31,75	12,1	56,2	12	2	24.000	16-11812P	F03FR01575	
12,7	12,5	51		1/4	2	24.000	16-10025P	F03FR01567
19	12,5	51		1/4	2	24.000	16-10425P	F03FR01570
12,7	12,5	60,5		1/2	2	24.000	16-11050P	F03FR01574
31,75	12,7	56,2		1/2	2	18.000	16-10850P	F03FR01572



AFGRATNINGSFRÆSERE

Flush afgratningsfræsere med topleje 50-

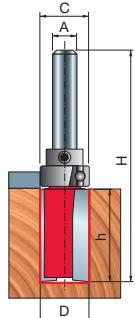

D	h	H	A	C	Z	Maks. omdr./min.	Freud-kode	Art.nr.
mm	mm	mm	mm	tomme	mm	1/min.		
13	20	60	6		13	24.000	50-10206P	F03FR02003
15	20	60	6		15	24.000	50-10406P	F03FR02006
19	25,4	67,5	6		19	24.000	50-10606P	F03FR02008
16	20	60	8		16	24.000	50-10308P	F03FR02005
22	20	60	8		22	24.000	50-10808P	F03FR02010
12,7	25,4	65,4		1/4	12,7	24.000	50-10225P	F03FR02004
15,88	25,4	65,4		1/4	15,88	24.000	50-10425P	F03FR02007
19	25,4	68,5		1/4	19	24.000	50-10625P	F03FR02009

Flush afgratningsfræser 42- 44-

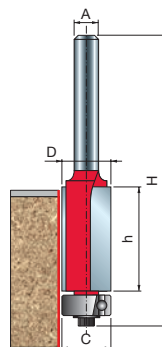

D	h	H	A	C	Z	Maks. omdr./min.	Freud-kode	Art.nr.	
mm	mm	mm	mm	tomme	mm	1/min.			
9,53	12,7	60,9	6		9,53	2	24.000	42-10206P	F03FR01935
9,53	25,8	72,4	6		9,53	2	24.000	42-10006P	F03FR01932
12,7	25,7	72,9	6		12,7	2	24.000	42-10406P	F03FR01938
9,53	12,7	60,9	8		9,53	2	24.000	42-10208P	F03FR01936
9,53	25,8	72,4	8		9,53	2	24.000	42-10008P	F03FR01933
12,7	25,7	72,9	8		12,7	2	24.000	42-10408P	F03FR01939
12,7	40	84	8		12,7	2	24.000	42-11508P	F03FR02771
12,7	25,4	82,5	12		12,7	2	24.000	42-11012P	F03FR01942
12,7	38,5	94,1	12		12,7	2	24.000	42-11412P	F03FR01944
12,7	50,8	106,8	12		12,7	2	24.000	42-11612P	F03FR01946
9,53	12,7	60,9		1/4	9,53	2	24.000	42-10225P	F03FR01937
9,53	25,8	72,4		1/4	9,53	2	24.000	42-10025P	F03FR01934
12,7	12,7	60,2		1/4	12,7	2	24.000	42-10625P	F03FR01941
12,7	25,7	72,9		1/4	12,7	2	24.000	42-10425P	F03FR01940
12,7	25,7	82,5		1/2	12,7	2	24.000	42-11050P	F03FR01943
12,7	38,5	94,1		1/2	12,7	2	24.000	42-11450P	F03FR01945
12,7	50,8	109,8		1/2	12,7	2	24.000	42-11650P	F03FR01947
12,7	38,5	94,1		1/2	12,7	3	24.000	44-10850P	F03FR01952

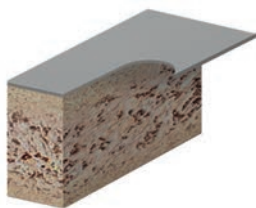

Flush afgratningsfræser med "V"-rille 48-

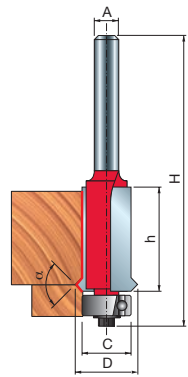

D	h	H	A	C	α	Z	Maks. omdr./min. 1/min.	Freud-kode	Art.nr.
mm	mm	mm	mm	mm					
15,88	25,4	76,2	6	12,7	90°	2	20.000	48-10206P	F03FR02000
15,88	25,4	76,2	8	12,7	90°	2	24.000	48-10208P	F03FR02001
15,88	25,4	87,2	12	12,7	90°	2	24.000	48-11212P	F03FR02002

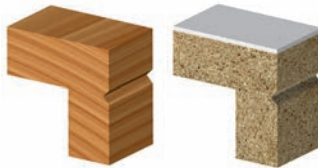

Panel-pilotfræser 26- 28-

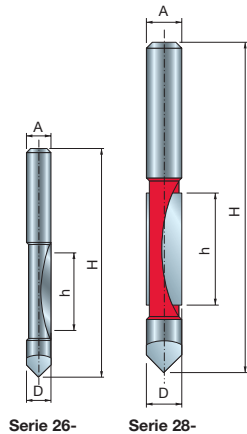
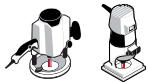

D	h	H	A	Z	Maks. omdr./min. 1/min.	Freud-kode	Art.nr.
mm	mm	mm	mm	tomme			
6	19	57	6	1	24.000	26-10006P	F03FR01664
8	19	75	8	1	24.000	26-10008P	F03FR01665
12,7	31,75	96,2	12	2	24.000	28-10412P	F03FR01692
6,35	19	57		1/4	24.000	26-10025P	F03FR01666
12,7	31,75	96,2		1/2	24.000	28-10450P	F03FR01693

- Hårdmetalfræsere

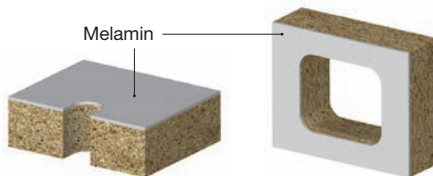



KANTFRÆSERE

Afrundingsfræser 34- 36-

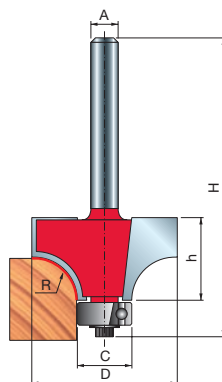

D	h	H	A	C	R	Z	Maks. omdr./min. 1/min.	Freud-kode	Art.nr.
mm	mm	mm	mm	tomme	mm	mm			
15,88	12,7	54,9	6	12,7	1,59	2	24.000	34-10006P	F03FR01763
16,7	12,7	54,9	6	12,7	2	2	24.000	34-10106P	F03FR02766
19,05	12,7	55,2	6	12,7	3,18	2	24.000	34-10406P	F03FR01768
22,22	12,7	54,9	6	12,7	4,8	2	24.000	34-10806P	F03FR01771
25,4	12,7	54,7	6	9,53	6,35	2	24.000	36-11006P	F03FR01803
25,4	12,7	55,2	6	12,7	6,35	2	24.000	34-11006P	F03FR01774
28,58	12,7	55,2	6	12,7	8	2	18.000	34-11206P	F03FR01777
31,75	18	59,7	6	12,7	9,53	2	18.000	34-11406P	F03FR01780
31,75	18	59,2	6	9,53	9,53	2	18.000	36-11406P	F03FR01804
38,1	19,1	61,25	6	12,7	12,7	2	16.000	34-11606P	F03FR01783

D	h	H	A	C	R	Z	Maks. omdr./min.	Freud-kode	Art.nr.	
mm	mm	mm	mm	tomme	mm	mm	1/min.			
15,88	12,7	54,9	8		12,7	1,59	2	24.000	34-10008P	F03FR01764
16,7	12,7	54,9	8		12,7	2	2	24.000	34-10108P	F03FR01766
18,7	12,7	54,9	8		12,7	3	2	24.000	34-10308P	F03FR01767
19,05	12,7	55,2	8		12,7	3,18	2	24.000	34-10408P	F03FR01769
22,22	13,2	54,9	8		12,7	4,75	2	24.000	34-10808P	F03FR01772
25,4	12,7	55,2	8		12,7	6,35	2	24.000	34-11008P	F03FR01775
28,58	12,7	55,2	8		12,7	7,94	2	18.000	34-11208P	F03FR01778
31,75	18	59,7	8		12,7	9,5	2	18.000	34-11408P	F03FR01781
38,1	19,1	61,25	8		12,7	12,7	2	16.000	34-11608P	F03FR01784
44,44	22,2	64,72	8		12,7	15,8	2	16.000	34-12708P	F03FR01793
25,4	12,7	61,2	12		12,7	6,35	2	24.000	34-12012P	F03FR01786
31,75	18	65,7	12		12,7	9,53	2	18.000	34-12412P	F03FR01788
38,1	19,05	67,25	12		12,7	12,7	2	16.000	34-12612P	F03FR01791
44,44	22,22	70,72	12		12,7	15,8	2	16.000	34-12712P	F03FR01794
50,8	25,4	73,9	12		12,7	19	2	16.000	34-12812P	F03FR01796
57,15	31,4	79,85	12		12,7	22,2	2	16.000	34-13012P	F03FR01798
63,5	31,3	79,75	12		12,7	25,4	2	12.000	34-13212P	F03FR01799
69,85	34,9	83,3	12		12,7	28,6	2	12.000	34-13412P	F03FR01801
76,2	38,1	86,6	12		12,7	31,8	2	12.000	34-13612P	F03FR01802
15,88	12,7	54,9		1/4	12,7	1,59	2	24.000	34-10025P	F03FR01765
19,05	12,7	55,2		1/4	12,7	3,18	2	24.000	34-10425P	F03FR01770
22,22	13,2	54,9		1/4	12,7	4,25	2	24.000	34-10825P	F03FR01773
25,4	12,7	55,2		1/4	12,7	6,35	2	24.000	34-11025P	F03FR01776
28,58	12,7	55,2		1/4	12,7	7,94	2	18.000	34-11225P	F03FR01779
31,75	18	59,7		1/4	12,7	9,53	2	18.000	34-11425P	F03FR01782
38,1	19,1	61,25		1/4	12,7	12,7	2	16.000	34-11625P	F03FR01785
25,4	12,7	61,2		1/2	12,7	6,35	2	24.000	34-12050P	F03FR01787
31,75	18	65,7		1/2	12,7	9,53	2	18.000	34-12450P	F03FR01790
38,1	19,1	67,25		1/2	12,7	12,7	2	16.000	34-12650P	F03FR01792
44,44	22,2	70,7		1/2	12,7	15,87	2	16.000	34-12750P	F03FR01795
50,8	25,4	73,9		1/2	12,7	19,05	2	16.000	34-12850P	F03FR01797
63,5	31,25	79,8		1/2	12,7	25,4	2	12.000	34-13250P	F03FR01800

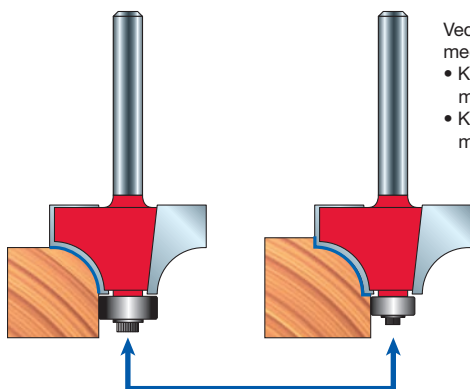

Ved bestilling af et mindre kugleleje og spændeskive med indstillinger vil du kunne få en anden profil:

- Kugleleje **3102M AA9** (Ø 9,53 mm) og spændeskive med indstillinger **FX07M AA9** til serie 34-
- Kugleleje **3102M AB9** (Ø 12,7 mm) og spændeskive med indstillinger **FX07M AB9** til serie 36-

Affasningsfræser

40-

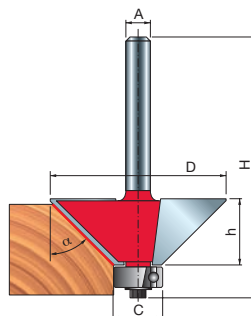
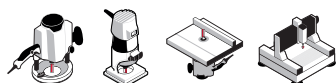

D	h	H	A	C	α	Z	Maks. omdr./min.	Freud-kode	Art.nr.	
mm	mm	mm	mm tomme	mm			1/min.			
18,15	12,7	54,9	6	12,7	15°	2	24.000	40-10006P	F03FR01906	
21,77	25	67,3	6	12,7	11.3°	2	24.000	40-09406P	F03FR01900	
23,6	12,7	54,9	6	12,7	25°	2	24.000	40-10206P	F03FR01912	
24	12	44	6	•	30°	2	24.000	40-90206P	F03FR01929	
24	14	46	6	•	15°	2	24.000	40-90006P	F03FR01927	
25	8	40,3	6	•	45°	2	24.000	40-90406P	F03FR01931	
25,4	25,1	67,25	6	12,7	15°	2	24.000	40-09806P	F03FR01903	
30,1	22,5	64,7	6	12,7	22.5°	2	18.000	40-10106P	F03FR01909	
31	9,5	52,3	6	12,7	45°	2	18.000	40-10506P	F03FR01917	
33	11,5	54	6	12,7	45°	2	16.000	40-10406P	F03FR01914	
33	19	61,6	6	12,7	30°	2	16.000	40-20206P	F03FR01925	
44	18,5	61	6	12,7	45°	2	16.000	40-10606P	F03FR01919	
18,15	12,7	54,9	8	12,7	15°	2	24.000	40-10008P	F03FR01907	
21,77	25	67,3	8	12,7	11.3°	2	24.000	40-09408P	F03FR01901	
23,6	12,7	54,9	8	12,7	25°	2	24.000	40-10208P	F03FR01913	
24	12	44	8	•	30°	2	24.000	40-90208P	F03FR01930	
24	14	46	8	•	15°	2	24.000	40-90008P	F03FR01928	
25	8	40,3	8	•	45°	2	24.000	40-90408P	F03FR03255	
25,4	25,1	67,25	8	12,7	15°	2	24.000	40-09808P	F03FR01904	
30,1	22,5	64,7	8	12,7	22.5°	2	18.000	40-10108P	F03FR01910	
31	9,5	52,3	8	12,7	45°	2	18.000	40-10508P	F03FR01918	
33	11,5	54	8	12,7	45°	2	16.000	40-10408P	F03FR01915	
33	19	61,6	8	12,7	30°	2	16.000	40-20208P	F03FR01926	
44	18,5	61	8	12,7	45°	2	16.000	40-10608P	F03FR01920	
21,77	25	73,3	12	12,7	11.3°	2	24.000	40-09412P	F03FR01902	
25,4	25,1	73,25	12	12,7	15°	2	24.000	40-09812P	F03FR01905	
30,1	22,5	70,7	12	12,7	22.5°	2	18.000	40-10112P	F03FR01911	
44	18,5	67	12	12,7	45°	2	16.000	40-11412P	F03FR01922	
62,1	25,5	74	12	12,7	45°	2	12.000	40-11812P	F03FR01924	
18,15	12,7	54,9		1/4	12,7	15°	2	24.000	40-10025P	F03FR01908
33	11,5	53,9		1/4	12,7	45°	2	24.000	40-10425P	F03FR01916
41,5	15,9	58,4		1/4	12,7	45°	2	16.000	40-10625P	F03FR01921
43	18,5	67		1/2	12,7	45°	2	16.000	40-11450P	F03FR01923

- Uden kugleleje.

Hulkelfræser med halvcirkelformet tværsnit 30-

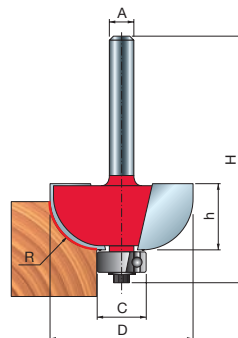

D	h	H	A	C	R	Z	Maks. omdr./min. 1/min.	Freud-kode	Art.nr.	
mm	mm	mm	mm	tomme	mm	mm				
19,05	14	56	6		9,53	4,76	2	24.000	30-10006P	F03FR01694
22,23	13,2	54,7	6		9,53	6,35	2	24.000	30-10206P	F03FR01697
25,4	12,7	54,7	6		9,53	8	2	24.000	30-10306P	F03FR01700
31,75	12,7	55,2	6		12,7	9,53	2	18.000	30-10406P	F03FR01703
38,1	16,4	58,9	6		12,7	12,7	2	16.000	30-10606P	F03FR01706
19,05	14	56	8		9,53	4,75	2	24.000	30-10008P	F03FR01695
22,23	13,2	54,7	8		9,53	6,35	2	24.000	30-10208P	F03FR01698
25,4	12,7	54,7	8		9,53	8	2	24.000	30-10308P	F03FR01701
31,75	12,7	55,2	8		12,7	9,53	2	18.000	30-10408P	F03FR01704
38,1	16,4	58,9	8		12,7	12,7	2	16.000	30-10608P	F03FR01707
19,05	14	62,4	12		9,53	4,75	2	24.000	30-10012P	F03FR01696
22,23	12,7	60,7	12		9,53	6,35	2	24.000	30-11012P	F03FR01709
25,4	12,7	60,7	12		9,53	8	2	24.000	30-11112P	F03FR01710
31,75	12,7	61,2	12		12,7	9,5	2	18.000	30-11212P	F03FR01711
38,1	16,4	64,9	12		12,7	12,7	2	16.000	30-11412P	F03FR01713
22,23	13,2	54,7		1/4	9,53	6,35	2	24.000	30-10225P	F03FR01699
25,4	12,7	54,7		1/4	9,53	7,94	2	24.000	30-10325P	F03FR01702
31,75	12,7	55,2		1/4	12,7	9,5	2	18.000	30-10425P	F03FR01705
38,1	16,4	58,9		1/4	12,7	12,7	2	16.000	30-10625P	F03FR01708
31,75	12,7	61,2		1/2	12,7	9,53	2	18.000	30-11250P	F03FR01712
38,1	16,4	64,9		1/2	12,7	12,7	2	16.000	30-11450P	F03FR01714

Klassisk Hulkelfræser med halvcirkelformet tværsnit 30-

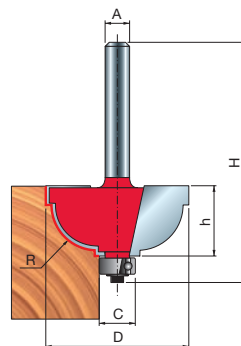

D	h	H	A	C	R	Z	Maks. omdr./min. 1/min.	Freud-kode	Art.nr.
mm	mm	mm	mm	mm	mm	mm			
28,58	13	54,2	6	9,53	4,8	2	18.000	30-30406P	F03FR01719
31,75	15,1	56,8	6	9,53	4,8	2	18.000	30-20206P	F03FR01715
28,58	13	54,2	8	9,53	4,8	2	18.000	30-30408P	F03FR01720
31,75	15,1	56,8	8	9,53	8	2	18.000	30-20208P	F03FR01716
28,58	13	60,2	12	9,53	4,8	2	18.000	30-32412P	F03FR01722
31,75	15,1	62,8	12	9,53	8	2	18.000	30-22212P	F03FR01718

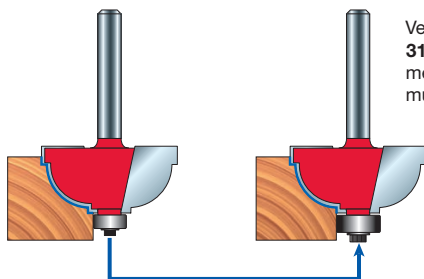

Ved ganske enkelt at bestille kuglelejet **3102M AB9** (Ø 12,7 mm) og spændeskiven med indstillinger **FX07M AB9** vil det være muligt at få en anden profil.

S-profilfræsere med trinformat detalje 38- 99-

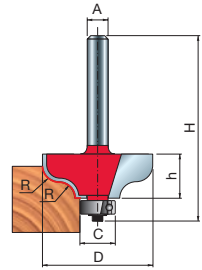

D	h	H	A	C	R	Z	Maks. omdr./min.	Freud-kode	Art.nr.	
mm	mm	mm	mm	tomme	mm	mm	1/min.			
31,75	12,2	53,9	6		9,53	4,8	2	18.000	38-20206P	F03FR01815
38,1	16,2	57,4	6		9,53	6,35	2	16.000	38-20406P	F03FR01818
31,75	12,2	53,9	8		9,53	4,8	2	18.000	38-20208P	F03FR01816
38,1	16,2	57,4	8		9,53	6,35	2	16.000	38-20408P	F03FR01819
31,75	12,2	59,9	12		9,53	4,8	2	18.000	38-21212P	F03FR01821
38,1	16,2	63,4	12		9,53	6,35	2	16.000	38-21412P	F03FR01822
31,75	12,2	53,9		1/4	9,53	4,76	2	18.000	38-20225P	F03FR01817
31,75	12,2	54,4		1/4	12,7	4,76	2	18.000	38-15225P	F03FR01814
38,1	16,2	57,4		1/4	9,53	6,35	2	16.000	38-20425P	F03FR01820
38,1	16,5	64,7		1/2	12,7	8,25	2	16.000	99-00650P	F03FR02412

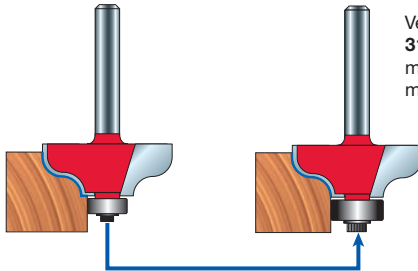

Ved ganske enkelt at bestille kuglelejet **3102M AB9** (Ø 12,7 mm) og spændeskiven med indstillinger **FX07M AB9** vil det være muligt at få en anden profil.

Romersk S-profilfræser 38-

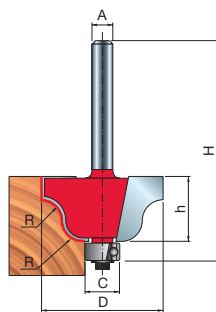

D	h	H	A	C	R	Z	Maks. omdr./min.	Freud-kode	Art.nr.
mm	mm	mm	mm tomme	mm	mm		1/min.		
27	13,3	55,3	6	9,53	4	2	18.000	38-10006P	F03FR01805
35	18,5	60,5	6	9,53	6,35	2	16.000	38-10206P	F03FR01808
27	13,3	55,3	8	9,53	4	2	18.000	38-10008P	F03FR01806
35	18,5	60,5	8	9,53	6,35	2	16.000	38-10208P	F03FR01809
27	13,3	61,31	12	9,53	4	2	18.000	38-10412P	F03FR01811
35	18,5	66,5	12	9,53	6,35	2	16.000	38-10612P	F03FR01812
27	13,3	55,3	1/4	9,53	4	2	18.000	38-10025P	F03FR01807
35	18,5	66,5	1/4	9,53	6,35	2	16.000	38-10225P	F03FR01810
35	18,5	66,5	1/2	9,53	6,35	2	16.000	38-10650P	F03FR01813

Klassisk romersk S-profilfræser 38- 99-

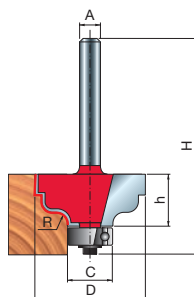

D	h	H	A	C	R	Z	Maks. omdr./min.	Freud-kode	Art.nr.
mm	mm	mm	mm tomme	mm	mm		1/min.		
31,75	15	56,7	6	12,7	3,18	2	18.000	38-40206P	F03FR01832
31,75	15	56,7	8	12,7	3,18	2	18.000	38-40208P	F03FR01833
34,92	14,3	62,8	12	12,7	4,8	2	16.000	99-00512P	F03FR02411
31,75	15	56,7	1/4	12,7	3,18	2	18.000	38-40225P	F03FR01834

Klassisk S-profilfræser 38- 99-

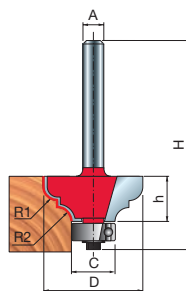

D	h	H	A	C	R1	R2	Z	Maks. omdr./min.	Freud-kode	Art.nr.	
mm	mm	mm	mm	tomme	mm	mm	mm	1/min.			
28,58	12,7	54,9	6		12,7	4	4	2	18.000	38-60206P	F03FR01838
34,92	18,3	60	6		12,7	6,35	4,76	2	16.000	38-60406P	F03FR01841
28,58	12,7	54,9	8		12,7	4	4	2	18.000	38-60208P	F03FR01839
34,92	18,3	60	8		12,7	6,35	4,76	2	16.000	38-60408P	F03FR01842
28,58	12,7	61,2	12		12,7	4	4	2	18.000	38-61212P	F03FR01843
34,92	17,5	65,7	12		12,7	6,35	4,76	2	16.000	38-61412P	F03FR01844
28,58	12,7	54,9	1/4		12,7	3,97	3,97	2	18.000	38-60225P	F03FR01840
34,93	14,7	62,4	1/2		9,53	5,35	5,35	2	16.000	99-00950P	F03FR02415
34,92	17,5	65,7	1/2		12,7	6,35	4,76	2	16.000	38-61450P	F03FR01845

Klassisk profilfræser til bordplader 99-

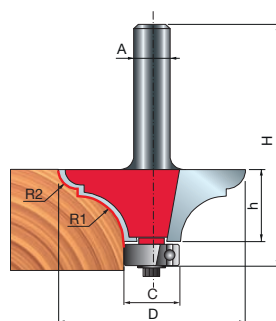
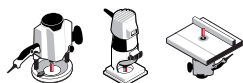

D	h	H	A	C	R1	R2	Z	Maks. omdr./min.	Freud-kode	Art.nr.
mm	mm	mm	mm	mm	mm	mm	mm	1/min.		
41,3	15,9	58,4	8	12,7	10	4,3	2	16.000	99-01108P	F03FR02416
41,3	15,9	64,4	12	12,7	10	4,3	2	16.000	99-01112P	F03FR02417

Profilfræser med lille forhøjning

38-

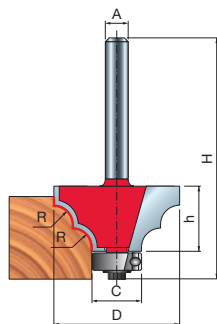

D	h	H	A	C	R	Z	Maks. omdr./min.	Freud-kode	Art.nr.
mm	mm	mm	mm	mm	mm		1/min.		
32,7	15	57,2	6	12,7	5	2	16.000	38-90006P	F03FR01852
32,7	15	57,2	8	12,7	5	2	16.000	38-90008P	F03FR01853

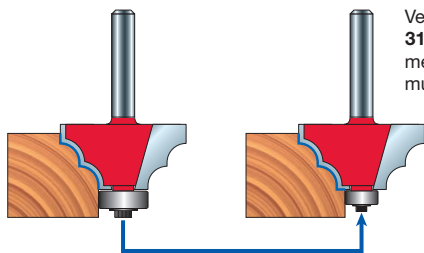

Ved ganske enkelt at bestille kuglelejet **3102M AA9** (Ø 9,53 mm) og spændeskiven med indstillinger **FX07M AA9** vil det være muligt at få en anden profil.

Profilfræser med dobbelt skær med halvcirkelformet tværsnit

38-

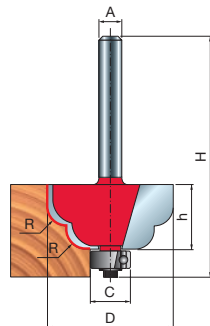

D	h	H	A	C	R	Z	Maks. omdr./min.	Freud-kode	Art.nr.	
mm	mm	mm	mm	tomme	mm	mm	1/min.			
32,7	15	57,2	6		12,7	5	2	16.000	38-95006P	F03FR01854
32,7	15	57,2	8		12,7	5	2	16.000	38-95008P	F03FR01855
38,9	18,3	60,8		1/4	9,53	6,35	2	16.000	38-30425P	F03FR01825

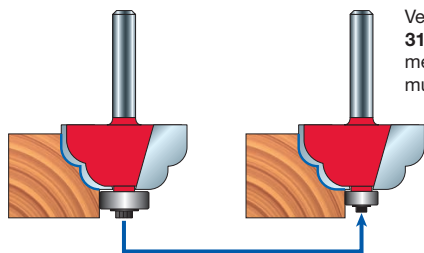

Ved ganske enkelt at bestille kuglelejet **3102M AA9** (Ø 9,53 mm) og spændeskiven med indstillinger **FX07M AA9** vil det være muligt at få en anden profil.

Profilfræser med fordybning og forhøjning 38-

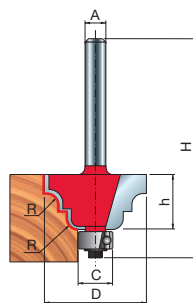

D	h	H	A	C	R	Z	Maks. omdr./min.	Freud-kode	Art.nr.
mm	mm	mm	mm	mm	mm		1/min.		
29,38	13,5	55,5	6	9,53	3,97	2	18.000	38-30606P	F03FR01826
38,9	18,3	60	6	9,53	6,35	2	16.000	38-30406P	F03FR01823
29,38	13,5	55,5	8	9,53	3,97	2	18.000	38-30608P	F03FR01827
38,9	18,3	60	8	9,53	6,35	2	16.000	38-30408P	F03FR01824
29,38	13,5	61,2	12	9,53	3,97	2	18.000	38-31212P	F03FR01829
38,92	18,3	66	12	9,53	6,35	2	16.000	38-31412P	F03FR01831

Profilfræser med fordybning og forhøjning med trinformat detalje 38-

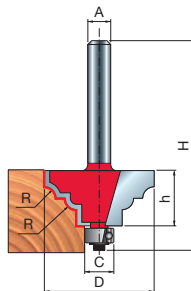

D	h	H	A	C	R	Z	Maks. omdr./min.	Freud-kode	Art.nr.
mm	mm	mm	mm	mm	mm		1/min.		
32,7	14,5	56,7	6	12,7	3	2	16.000	38-80006P	F03FR01846
36,7	16,5	58,7	6	12,7	4	2	16.000	38-80206P	F03FR01848
40,7	18	60,2	6	12,7	5	2	16.000	38-80406P	F03FR01850
32,7	14,5	56,7	8	12,7	3	2	16.000	38-80008P	F03FR01847
36,7	16,5	58,7	8	12,7	4	2	16.000	38-80208P	F03FR01849
40,7	18	60,2	8	12,7	5	2	16.000	38-80408P	F03FR01851

Dobbelt S-profilfræser med trinformat detalje 38-

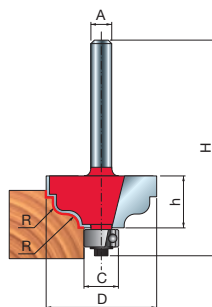

D	h	H	A	C	R	Z	Maks. omdr./min.	Freud-kode	Art.nr.
mm	mm	mm	mm	tomme	mm	mm	1/min.		
31,75	15	56,2	6	9,53	3,18	2	18.000	38-45206P	F03FR01835
31,75	15	56,2	8	9,53	3,18	2	18.000	38-45208P	F03FR01836
31,75	15	56,2	1/4	9,53	3,18	2	18.000	38-45225P	F03FR01837

Halvstavfræser 80-

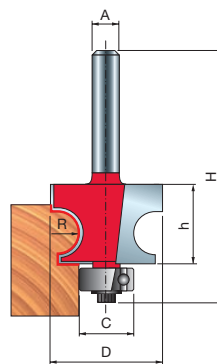

D	h	H	A	C	R	Z	Maks. omdr./min.	Freud-kode	Art.nr.
mm	mm	mm	mm	mm	mm	mm	1/min.		
22,23	14,3	56,9	6	12,7	3,18	2	24.000	80-10206P	F03FR02192
25,4	17,5	60	6	12,7	4,76	2	24.000	80-10406P	F03FR02195
30,17	22,2	64,2	6	12,7	7,14	2	18.000	80-10806P	F03FR02198
22,23	14,3	57,1	8	12,7	3,18	2	24.000	80-10208P	F03FR02193
25,4	17,5	60	8	12,7	4,76	2	24.000	80-10408P	F03FR02196
30,17	22,2	64,2	8	12,7	7,14	2	18.000	80-10808P	F03FR02199
22,23	14,3	62,9	12	12,7	3,18	2	24.000	80-12212P	F03FR02201
25,4	17,5	66,4	12	12,7	4,76	2	24.000	80-12412P	F03FR02203
30,17	22,2	70,6	12	12,7	7,14	2	18.000	80-12812P	F03FR02204

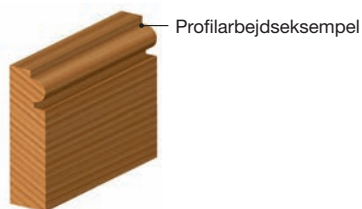

Halvstavfræser triple 80-

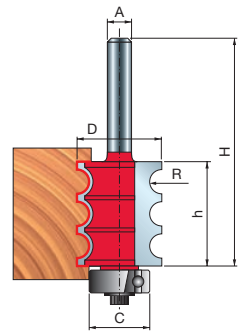

D	h	H	A	C	R	Z	Maks. omdr./min.	Freud-kode	Art.nr.
mm	mm	mm	mm	mm	mm		1/min.		
22,24	27,4	70,9	6	15,88	3,18	2	18.000	80-55206P	F03FR02205
22,24	27,4	70,9	8	15,88	3,18	2	24.000	80-55208P	F03FR02206
22,24	27,4	76,9	12	15,88	3,18	2	24.000	80-57212P	F03FR02207

Tripple profilfræser 84-

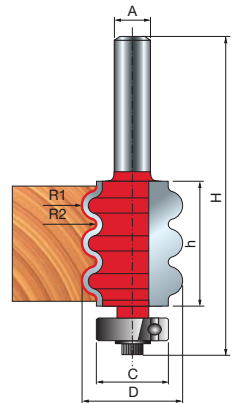

D	h	H	A	C	R1	R2	Z	Maks. omdr./min.	Freud-kode	Art.nr.
mm	mm	mm	mm	mm	mm	mm		1/min.		
22,24	27,4	70,9	6	15,88	3,18	1,16	2	24.000	84-10606P	F03FR02220
22,24	27,4	70,9	8	15,88	3,18	1,16	2	24.000	84-10608P	F03FR02221
22,24	27,4	76,9	12	15,88	3,18	1,16	2	24.000	84-12612P	F03FR02222

Fordybningsprofil fræser med s-profil topleje

23-



Type A

D	h	H	A	C	R	Z	Maks. omdr./min.	Freud-kode	Art.nr.
mm	mm	mm	mm	mm	mm		1/min.		
39,5	11,5	54,6	8	19	4	2	16.000	23-10008P	F03FR01654
39,5	11,5	58	12	19	4	2	16.000	23-10012P	F03FR01655
54	11,5	58	12	19	4	2	16.000	23-10212P	F03FR01656
60,5	17,3	63,8	12	19	6,35	2	12.000	23-10412P	F03FR01657

Type B

D	h	H	A	C	R	Z	Maks. omdr./min.	Freud-kode	Art.nr.
mm	mm	mm	mm	mm	mm		1/min.		
38	12,5	55,6	8	19	6,35	2	16.000	23-20008P	F03FR01658
38	12,5	59	12	19	6,35	2	16.000	23-20012P	F03FR01659

Type C

D	h	H	A	C	R	Z	Maks. omdr./min.	Freud-kode	Art.nr.
mm	mm	mm	mm	mm	mm		1/min.		
35	13,2	56,3	8	19	8	2	16.000	23-20208P	F03FR01660
38	14,5	57,6	8	19	9,53	2	16.000	23-20408P	F03FR01662
35	13,2	59,7	12	19	8	2	16.000	23-20212P	F03FR01661
38	14,5	61	12	19	9,53	2	16.000	23-20412P	F03FR01663

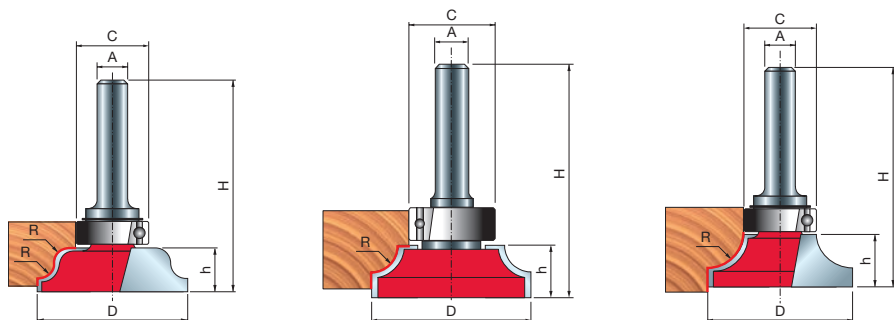

Bordkant- og gelænder profilfræser 99-



Type A

D	h	H	A	C	R1	R2	α	Z	Maks. omdr./min.	Freud-kode	Art.nr.
mm	mm	mm	mm	mm	mm	mm			1/min.		
63,5	18	66,2	12	12,7	30	8	15°	2	12.000	99-02712P	F03FR02421

Type B

D	h	H	A	C	R	α	Z	Maks. omdr./min.	Freud-kode	Art.nr.
mm	mm	mm	mm	mm	mm			1/min.		
35	38,5	86,6	12	12,7	3,18	25°	2	16.000	99-07212P	F03FR02456

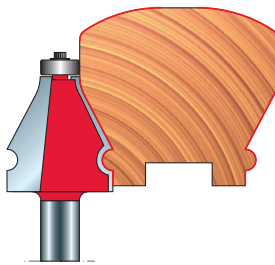
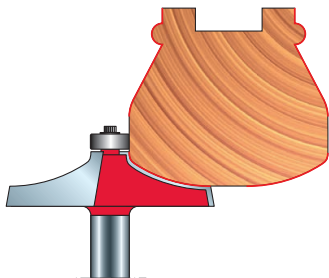
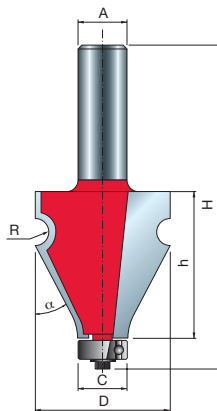
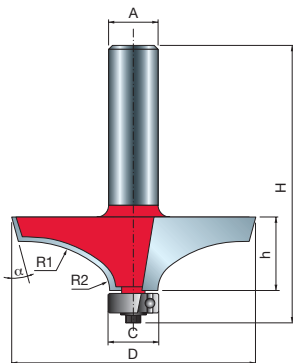

Fladstavfræser 82-

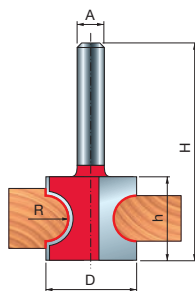
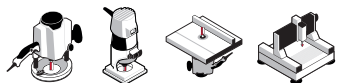

D	h	H	A	R	Z	Maks. omdr./min.	Freud-kode	Art.nr.	
mm	mm	mm	mm	tomme	mm	1/min.			
19	12,4	44,4	6		3,18	2	24.000	82-10206P	F03FR02208
22,22	19,5	51,5	6		4,8	2	24.000	82-10406P	F03FR02210
25,4	22,9	54,9	6		6,35	2	24.000	82-10606P	F03FR02213
19	12,4	44,4	8		3,18	2	24.000	82-10208P	F03FR02209
22,22	19,5	51,5	8		4,76	2	24.000	82-10408P	F03FR02211
25,4	22,9	54,9	8		6,35	2	24.000	82-10608P	F03FR02214
19	12,4	53,4	12		3,2	2	24.000	82-11012P	F03FR02215
22,22	19,5	60,5	12		4,76	2	24.000	82-11212P	F03FR02216
25,4	22,9	64,9	12		6,35	2	24.000	82-11412P	F03FR02217
37	29,05	71,05	12		9,5	2	16.000	82-11612P	F03FR02218
45,9	35,4	73,4	12		12,7	2	16.000	82-11812P	F03FR02219
22	19,5	51,5		1/4	4,76	2	24.000	82-10425P	F03FR02212

Multiprofilfræser

99-



D	h	H	A	C	R1	R2	R2	Z	Maks. omdr./min.	Freud-kode	Art.nr.
mm	mm	mm	mm	mm	mm	mm	mm		1/min.		
54,7	49	102	12	12,7	6	8	10	2	10.000	99-PK112P	F03FR02406
31,75	20	58	12	-	2,4	9,53	-	2	18.000	99-PK212P	F03FR02408
31,75	23,8	72	12	12,7	3,2	9,53	2,4	2	18.000	99-PK312P	F03FR02409
44,44	29	77,1	12	12,7	3	10,5	7	2	16.000	99-00812P	F03FR02414
23,8	35	83,5	12	12,7	4	15	-	2	24.000	99-01212P	F03FR02418
23,8	35	83,5	12	12,7	3,5	4,5	8,5	2	24.000	99-01312P	F03FR02419

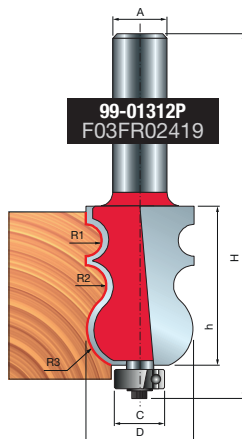
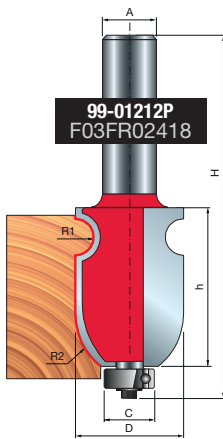
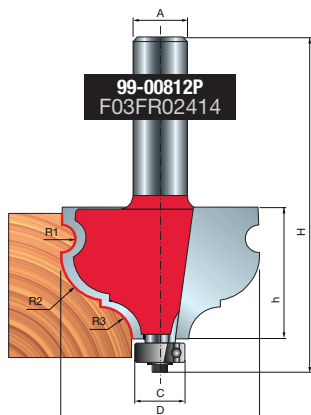
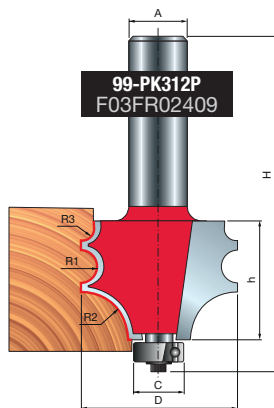
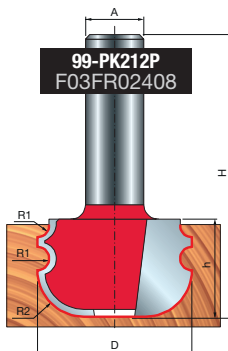
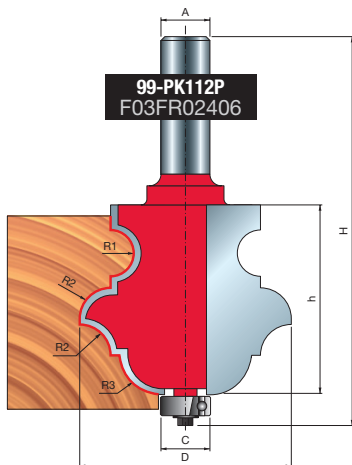

Afrundingsfræser 85-

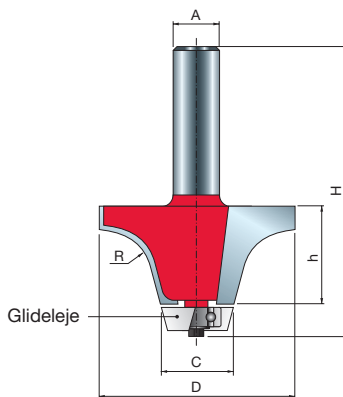

D	h	H	A	C	R	Z	Maks. omdr./min.	Freud-kode	Art.nr.
mm	mm	mm	mm tomme	mm	mm		1/min.		
54	25,4	74,6	12	22,2	12,7	2	16.000	85-00112P	F03FR02223
57,2	31,8	81	12	22,2	12,7	2	12.000	85-00312P	F03FR02225
50,8	25,4	73,6	1/2	19,1	12,7	2	16.000	85-00150P	F03FR02224

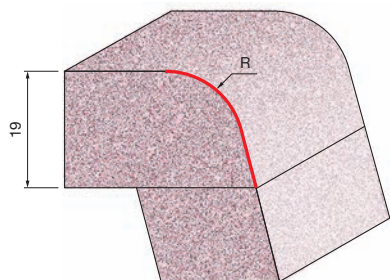
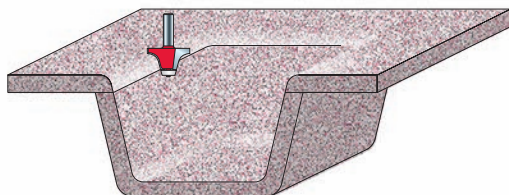

85-00112P
F03FR02223

85-00150P
F03FR02224

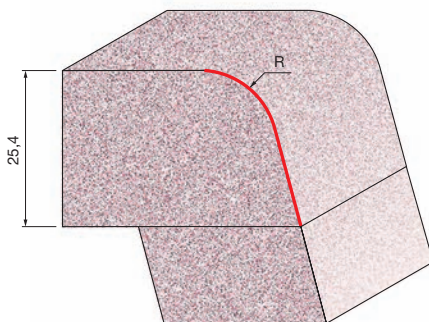

85-00312P
F03FR02225

S-profil skålfærser 85-

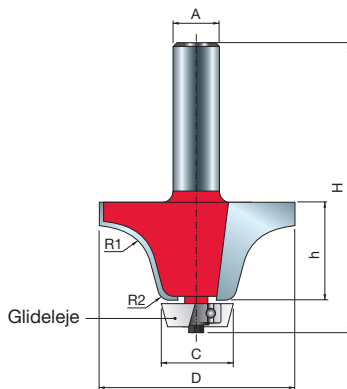

D	h	H	A	C	R1	R2	Z	Maks. omdr./min.	Freud-kode	Art.nr.
mm	mm	mm	mm	mm	mm	mm		1/min.		
54	25,4	74,6	12	19,2	12,7	6,35	2	16.000	85-00512P	F03FR02226
57,2	31,8	80,9	12	19,2	12,7	6,35	2	12.000	85-00712P	F03FR02227

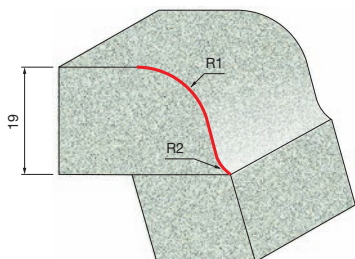
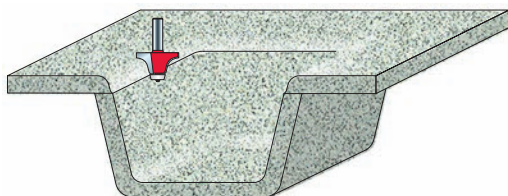

85-00512P
F03FR02226

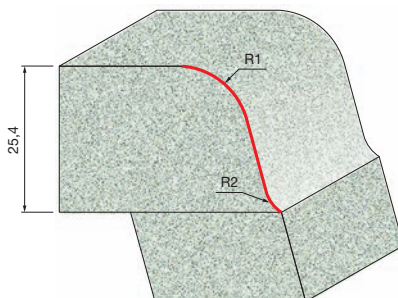

85-00712P
F03FR02227

Afrundingsfræser til affasning 85-

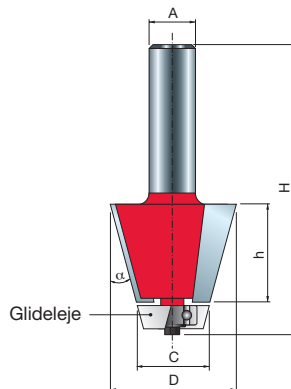

D	h	H	A	C	α	Z	Maks. omdr./min.	Freud-kode	Art.nr.
mm	mm	mm	mm	mm			1/min.		
35,6	25,4	78,1	12	22,2	15°	2	16.000	85-00912P	F03FR02228

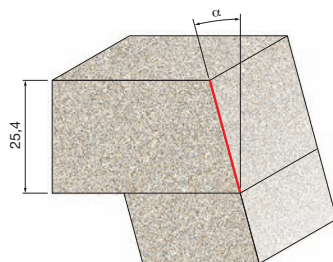
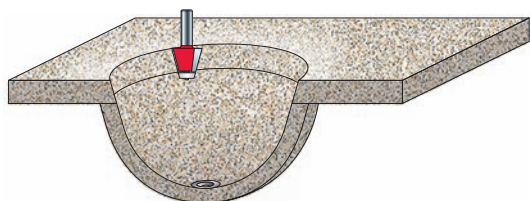

Bølget samlingsfræser 85-

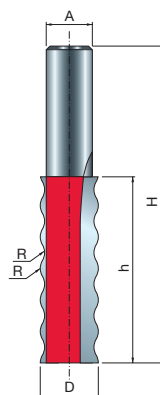
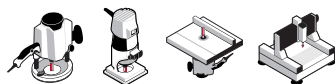

D	h	H	A	α	Z	Maks. omdr./min.	Freud-kode	Art.nr.
mm	mm	mm	mm			1/min.		
16	51,3	88	12	4	2	24.000	85-03312P	F03FR02229

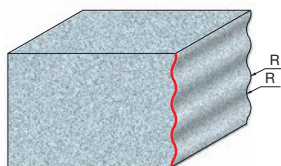



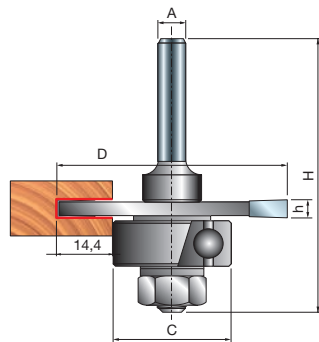

SAMLINGSFRÆSERE

Skivenotfræser 63-



D	h	H	A	C	Z	Maks. omdr./min. 1/min.	Freud-kode	Art.nr.
mm	mm	mm	mm	mm	mm			
50,8	1,5	60,3	6	22	3	24.000	63-09906P	F03FR02049
50,8	1,6	60,3	6	22	3	24.000	63-10006P	F03FR02055
50,8	2	60,3	6	22	3	24.000	63-10406P	F03FR02058
50,8	2,4	60,3	6	22	3	24.000	63-10606P	F03FR02061
50,8	2,5	60,3	6	22	3	24.000	63-11306P	F03FR02079
50,8	3	60,3	6	22	3	24.000	63-11406P	F03FR02085
50,8	3,2	60,3	6	22	3	24.000	63-10806P	F03FR02064
50,8	3,5	60,3	6	22	3	24.000	63-11506P	F03FR02091
50,8	4	60,3	6	22	3	24.000	63-10906P	F03FR02067
50,8	4,8	60,3	6	22	3	24.000	63-11006P	F03FR02070
50,8	5	60,3	6	22	3	24.000	63-11606P	F03FR02097
50,8	6	60,3	6	22	3	24.000	63-11106P	F03FR02073

D	h	H	A	C	Z	Maks. omdr./min.	Freud-kode	Art.nr.
mm	mm	mm	mm	mm		1/min.		
50,8	6,4	60,3	6	22	3	24.000	63-11206P	F03FR02076
50,8	1,5	60,3	8	22	3	24.000	63-09908P	F03FR02052
50,8	2,5	60,3	8	22	3	24.000	63-11308P	F03FR02082
50,8	3	60,3	8	22	3	24.000	63-11408P	F03FR02088
50,8	3,5	60,3	8	22	3	24.000	63-11508P	F03FR02094
50,8	5	60,3	8	22	3	24.000	63-11608P	F03FR02100
50,8	1,5	60,3	12	22	3	24.000	63-14912P	F03FR02105
50,8	1,6	60,3	12	22	3	24.000	63-15012P	F03FR02108
50,8	2	60,3	12	22	3	24.000	63-15412P	F03FR02111
50,8	2,4	60,3	12	22	3	24.000	63-15612P	F03FR02114
50,8	2,5	60,3	12	22	3	24.000	63-16312P	F03FR02132
50,8	3	60,3	12	22	3	24.000	63-16412P	F03FR03241
50,8	3,2	60,3	12	22	3	24.000	63-15812P	F03FR02117
50,8	3,5	60,3	12	22	3	24.000	63-16512P	F03FR02137
50,8	4	60,3	12	22	3	24.000	63-15912P	F03FR02120
50,8	4,8	60,3	12	22	3	24.000	63-16012P	F03FR02123
50,8	5	60,3	12	22	3	24.000	63-16612P	F03FR02140
50,8	6	60,3	12	22	3	24.000	63-16112P	F03FR02126
50,8	6,4	60,3	12	22	3	24.000	63-16212P	F03FR02129

	Reserve dele	Dimensioner mm	Freud-kode	Art.nr.
	Spændeskive	17 x 8,4 x 1,6	2617M AG9	F03F010005
	Hex-møtrik	7,94 x 6,75	2610M BB9	F03F010003
	Kugleleje	22 x 8 x 7,1	3102M AC9	F03F010008

Notskærere

56- 58-

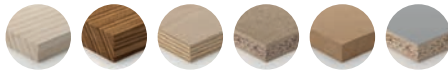
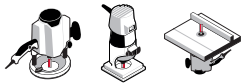

Z=3

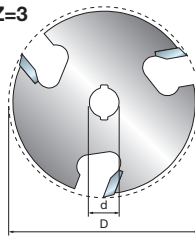

Z=4

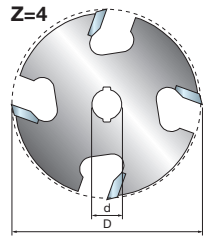

D	h	d	Z	Maks. omdr./min.	Freud-kode	Art.nr.
mm	mm	mm		1/min.		
50,8	1,5	8	3	24.000	56-09908P	F03FR02014
50,8	1,6	8	3	16.000	56-10008P	F03FR02015
50,8	2	8	3	24.000	56-10408P	F03FR02016
50,8	2,4	8	3	16.000	56-10608P	F03FR02017
50,8	2,5	8	3	24.000	56-11308P	F03FR02028
50,8	3	8	3	24.000	56-11408P	F03FR02029
50,8	3,2	8	3	24.000	56-10808P	F03FR02019
50,8	3,5	8	3	24.000	56-11508P	F03FR02030
50,8	4	8	3	24.000	56-10908P	F03FR02021
50,8	4,8	8	3	24.000	56-11008P	F03FR02023
50,8	5	8	3	24.000	56-11608P	F03FR02031
50,8	6	8	3	24.000	56-11108P	F03FR02025
50,8	6,4	8	3	24.000	56-11208P	F03FR02026

D	h	d	Z	Maks. omdr./min.	Freud-kode	Art.nr.
mm	mm	mm		1/min.		
50,8	1,5	8	4	16.000	58-09908P	F03FR02032
50,8	2	8	4	16.000	58-10408P	F03FR02033
50,8	2,5	8	4	16.000	58-11308P	F03FR02036
50,8	3	8	4	16.000	58-11408P	F03FR02037
50,8	5	8	4	24.000	58-11608P	F03FR02038
50,8	6	8	4	16.000	58-11108P	F03FR02034

Slidsfræserorne 60-



D	h1	h2	H	C	A	Maks. omdr./min.	Freud-kode	Art.nr.
mm	mm	mm	mm	mm	mm tomme	1/min.		
7,94	24,6	10	60,3	-	6	24.000	60-10006P	F03FR02039
7,94	24,6	10	60,3	22	6	24.000	60-12006P	F03FR02044
7,94	24,6	10	60,3	-	8	24.000	60-10008P	F03FR02040
7,94	24,6	10	60,3	22	8	24.000	60-12008P	F03FR02045
7,94	24,6	10	60,3	-	12	24.000	60-10212P	F03FR02042
7,94	24,6	10	60,3	22	12	24.000	60-12212P	F03FR02046
7,94	24,6	10	60,3	-	1/4	24.000	60-10025P	F03FR02041
7,94	24,6	10	60,3	-	1/2	24.000	60-10250P	F03FR02043

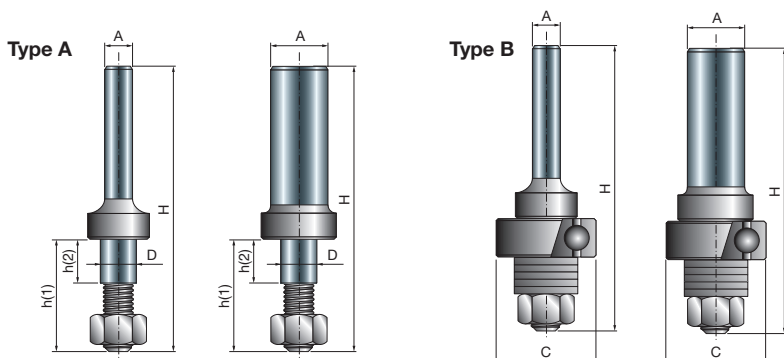

Type A

60-10006P - 60-10008P - 60-10212P - 60-10025P - 60-10250P

	Mængde	Reserve dele	Dimensioner mm	Freud-kode	Art.nr.
	7	Spændeskive	17 x 8,4 x 1,6	2617M AG9	F03F010005
	1	Hex-møtrik	7,94 x 6,75	2610M BB9	F03F010003

Type B

60-12006P - 60-12008P - 60-12212P

	Mængde	Reserve dele	Dimensioner mm	Freud-kode	Art.nr.
	5	Spændeskive	17 x 8,4 x 1,6	2617M AG9	F03F010005
	1	Hex-møtrik	7,94 x 6,75	2610M BB9	F03F010003
	1	Kugleleje	22 x 8 x 7	3102M AC9	F03F010008

Slidsfræser med kiksесamling 63-

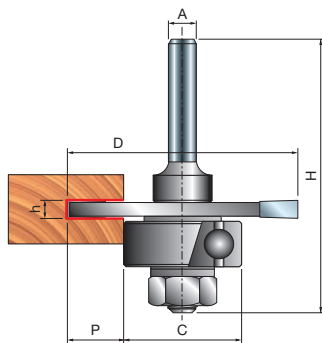

D	h	H	C	P	A	Z	Maks. omdr./min.	Freud-kode	Art.nr.	
mm	mm	mm	mm	mm	mm	tomme	1/min.			
50,8	3,97	60,3	26-30-34	12,4-10,4-8,4	6	3	24.000	63-60906P	F03FR02143	
50,8	3,97	60,3	26-30-34	12,4-10,4-8,4	8	3	24.000	63-60908P	F03FR02146	
50,8	3,97	60,3	26-30-34	12,4-10,4-8,4	12	3	24.000	63-60912P	F03FR02149	
50,8	3,97	60,3	26-30-34	12,4-10,4-8,4		1/4	3	24.000	63-60925P	F03FR02152
50,8	3,97	60,3	26-30-34	12,4-10,4-8,4		1/2	3	24.000	63-60950P	F03FR02155

	Reserve dele	Dimensioner mm	Freud-kode	Art.nr.
	Hex-møtrik	7,94 x 6,75	2610M BB9	F03F010003
	Spændeskive	17 x 8,4 x 1,6	2617M AG9	F03F010005
	Spændeskive	14 x 8,4 x 1,6	2617M BG9	F03FR01668
	Kugleleje	26 x 10 x 8	RB62M 1249	F03F011417
	Kugleleje	30 x 10 x 8	RB62M 1289	F03F011418
	Kugleleje	34 x 10 x 8	RB62ME DA9	F03FR01146

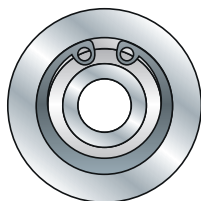

Kiksестр. -00
47 mm x 15 mm

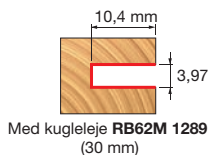
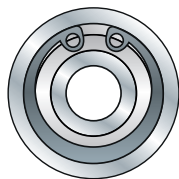
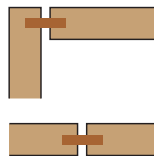

Kiksестр. -10
54 mm x 19 mm

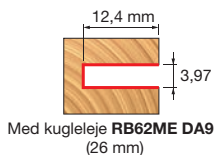
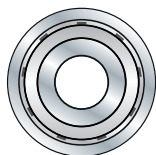

Kiksестр. -20
59 mm x 22 mm

• Justerbart
fer- notskærersæt
99-

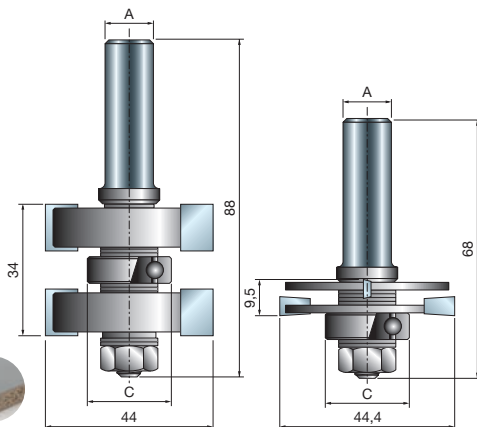

D	h	H	A	C	Z	Maks. omdr./min. 1/min.	Freud-kode	Art.nr.
mm	mm	mm	mm	mm				
44	34	88	12	22	2	16.000	99-03612P	F03FR02432
44,4	9,5	68	12	22	2			

	Mængde	Reserve dele	Dimensioner mm	Freud-kode	Art.nr.
	2	Hex-møtrik	7,94 x 6,75	2610M BB9	F03F010003
	2	Spændeskive	14 x 8,4 x 1,6	2617M BG9	F03FR01668
	2	Kugleleje	22 x 8 x 7,1	3102M AC9	F03F010008
	4	Afstandsholder	18 x 0,1 x 8	AN01MP0019	F03FC00392
	4	Afstandsholder	18 x 0,2 x 8	AN01MP0029	F03FC00393
	2	Afstandsholder	18 x 0,5 x 8	AN01MP0059	F03FC00395
	8	Afstandsholder	18 x 1 x 8	AN01MP0109	F03FC00396
	4	Afstandsholder	18 x 0,15 x 8	AN01MPAA99	F03FC00391

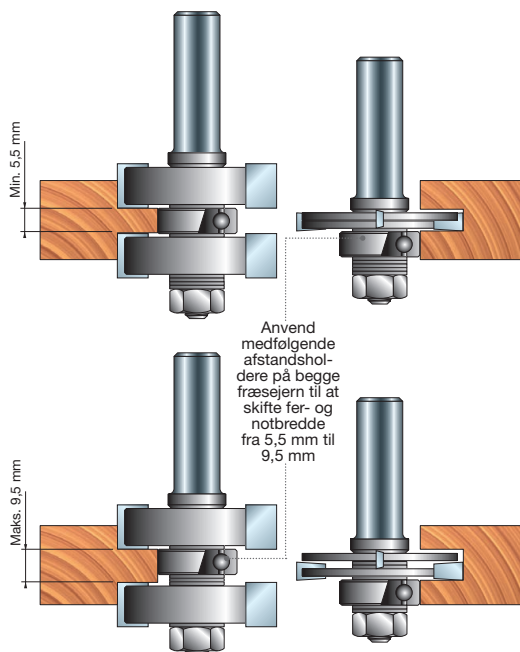

Fer- og notsamplingsfræser 32-

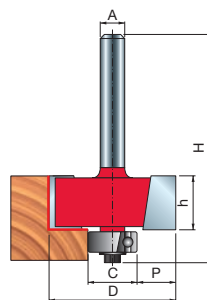

D	h	H	A	C	R	Z	Maks. omdr./min.	Freud-kode	Art.nr.	
mm	mm	mm	mm	tomme	mm	mm	1/min.			
31,75	13,2	55,7	6		12,7	9,52	2	18.000	32-10006P	F03FR01745
34,92	12,7	54,4	6		12,7	11,1	2	16.000	32-50006P	F03FR01750
31,75	13,2	55,7	8		12,7	9,52	2	18.000	32-10008P	F03FR01746
34,92	12,7	54,7	8		12,7	11,1	2	16.000	32-50008P	F03FR01751
31,75	13,2	61,7	12		12,7	9,52	2	18.000	32-10212P	F03FR01748
34,92	12,7	60,7	12		12,7	11,1	2	16.000	32-52012P	F03FR01758
31,75	13,2	55,7		1/4	12,7	9,52	2	18.000	32-10025P	F03FR01747
31,75	13,2	61,7		1/2	12,7	9,52	2	18.000	32-10250P	F03FR01749







Fer- og notsamplingsfræser med lejesæt











Fer- og notsamplingsfræser med et sæt bestående af 4 kuglelejer

D	h	H	A	C	P	Z	Maks. omdr./min.	Freud-kode	Art.nr.	
mm	mm	mm	mm	tomme	mm	mm	1/min.			
34,92	12,7	54,4	6		9,53-19,05	7,94-12,7	2	16.000	32-50206P	F03FR01752
34,92	12,7	54,4	8		9,53-19,05	7,94-12,7	2	16.000	32-50208P	F03FR01753
34,92	12,7	60,7	12		9,53-19,05	7,94-12,7	2	16.000	32-52212P	F03FR01759
34,92	12,7	60,7		1/2	9,53-15,88	9,53-12,7	2	16.000	32-52250P	F03FR01760

Fer- og notsamplingsfræser med et sæt bestående af 7 kuglelejer

D	h	H	A	C	P	Z	Maks. omdr./min.	Freud-kode	Art.nr.
mm	mm	mm	mm	mm	mm	mm	1/min.		
34,92	12,7	54,7	6	9,53-34,92	0-12,7	2	16.000	32-50406P	F03FR01755
34,92	12,7	54,4	8	9,53-34,92	0-12,7	2	16.000	32-50408P	F03FR01756
34,92	12,7	60,7	12	9,53-34,92	0-12,7	2	16.000	32-52412P	F03FR01761

	Reserve dele	Dimensioner mm	Freud-kode	Art.nr.
	 Skruer	M3 x 7,6	2607M 001	F03F010000
	 Umbrakonøgle	2,5	2619M CA9	F03FA07432
	 Spændeskive	9 x 2 x 6	FX07M AA9	F03F010158
	 Spændeskive	12 x 1,1 x 4,8	FX07M AB9	F03F010159
32-52250P	 Kugleleje	9,53 x 3,2 x 4,76	3102M AA9	F03F010006
	 Kugleleje	12,7 x 4,98 x 4,76	3102M AB9	F03F010007
	 Kugleleje	15,88 x 4,97 x 4,76	3102M AJ9	F03F010014

		Reservelele	Dimensioner mm	Freud-kode	Art.nr.
32-50206P 32-50208P 32-52212P		Kugleleje	9,53 x 3,2 x 4,76	3102M AA9	F03F010006
		Kugleleje	12,7 x 4,98 x 4,76	3102M AB9	F03F010007
		Kugleleje	15,88 x 4,97 x 4,76	3102M AJ9	F03F010014
32-50406P 32-50408P 32-52412P		Kugleleje	19,05 x 8 x 4,76	RB62M 1509	F03F011422
		Kugleleje	9,53 x 3,2 x 4,76	3102M AA9	F03F010006
		Kugleleje	12,7 x 4,98 x 4,76	3102M AB9	F03F010007
		Kugleleje	15,88 x 4,97 x 4,76	3102M AJ9	F03F010014
		Kugleleje	19,05 x 8 x 4,76	RB62M 1509	F03F011422
		Kugleleje	22,22 x 8 x 4,76	RB62M 1529	F03F011423
		Kugleleje	28,58 x 8 x 4,76	RB62M 1549	F03F011424
		Kugleleje	34,92 x 8 x 4,76	RB62M 1569	F03F011425

Nøglehulsfræser 70-

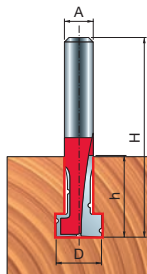
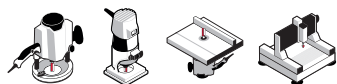

D	h	H	A	Z	Maks. omdr./min.	Freud-kode	Art.nr.
mm	mm	mm	mm		1/min.		
10	17	48,2	6	2	24.000	70-10406P	F03FR02159



Eksempel på nøglehul

T-rillet fræser 52-

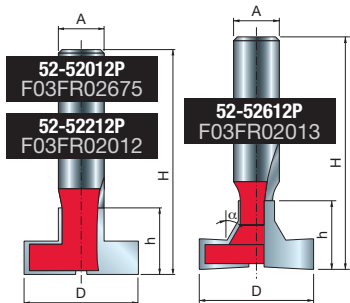
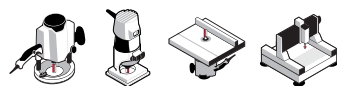

D	h	H	A	α	Z	Maks. omdr./min.	Freud-kode	Art.nr.
mm	mm	mm	mm			1/min.		
28	16	59	12	-	2	22.000	52-52012P	F03FR02675
28,58	20,6	63,5	12	-	2	18.000	52-52212P	F03FR02012
30	18	61	12	30°	2	18.000	52-52612P	F03FR02013

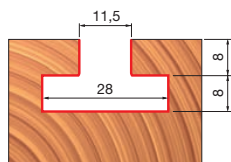

52-52012P
F03FR02675

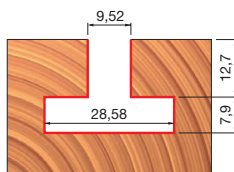

52-52212P
F03FR02012

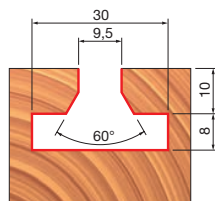

52-52612P
F03FR02013

Svalehalefræser 22-

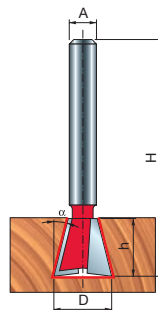
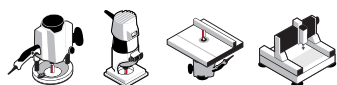

D	h	H	A	α	Z	Maks. omdr./min.	Freud-kode	Art.nr.
mm	mm	mm	mm	tomme		1/min.		
9,52	10,5	47,5	6	9°	2	24.000	22-10206P	F03FR01640
12,7	12,7	50,7	6	14°	2	24.000	22-10406P	F03FR01643
15,88	22,2	54,2	6	7°	2	24.000	22-10506P	F03FR01646
19,05	22,2	54,2	6	7°	2	24.000	22-10606P	F03FR01648
9,52	10,5	47,5	8	9°	2	24.000	22-10208P	F03FR01641
12,7	12,7	50,7	8	14°	2	24.000	22-10408P	F03FR01644
15,88	22,2	54,2	8	7°	2	24.000	22-10508P	F03FR01647
19,05	22,2	54,2	8	7°	2	24.000	22-10608P	F03FR01649
12,7	12,7	59,7	12	14°	2	24.000	22-11212P	F03FR01650
19,05	22,2	66,7	12	7°	2	24.000	22-11412P	F03FR01653
9,52	9,9	44,9	1/4	9°	2	24.000	22-10225P	F03FR01642
12,7	12,7	50,7	1/4	14°	2	24.000	22-10425P	F03FR01645
12,7	12,7	59,7	1/2	14°	2	24.000	22-11250P	F03FR01651

Låse-geringsfræser 45° 99-

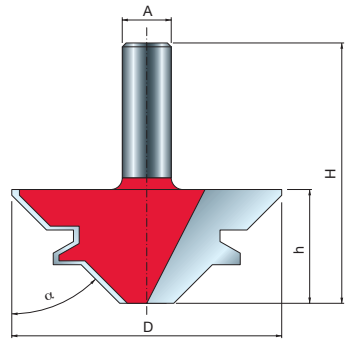
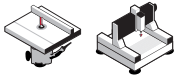

D	h	H	A	α	Z	Maks. omdr./min.	Freud-kode	Art.nr.
mm	mm	mm	mm			1/min.		
55	23	61	12	45°	2	16.000	99-03512P	F03FR02425
70	29,5	67,5	12	45°	2	12.000	99-03412P	F03FR02424

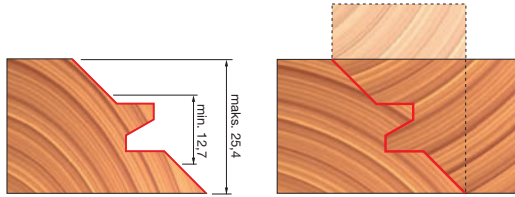

Enkel samling

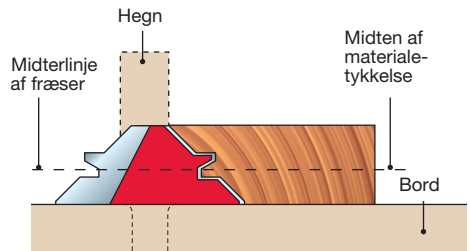
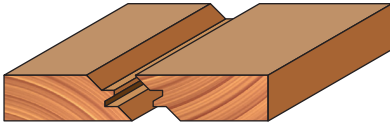

45° geringsamling

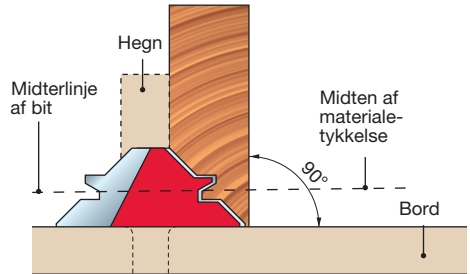
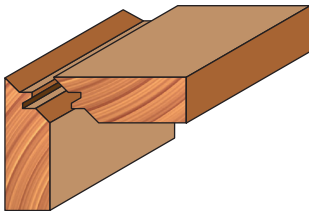

2 stk. låse-geringsfræsesæt 22,5°
99-

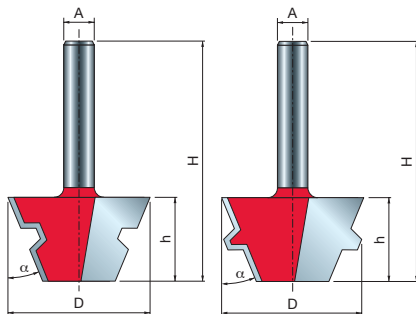
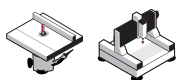

D	h	H	A	α	Z	Maks. omdr./min.	Freud-kode	Art.nr.
mm	mm	mm	mm			1/min.		
37,3	22,2	54,2	8	22,5°	2	24.000	99-04308P	F03FR02450

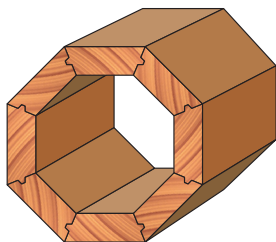
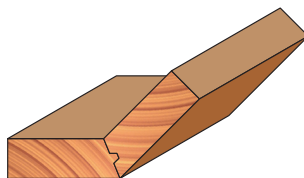
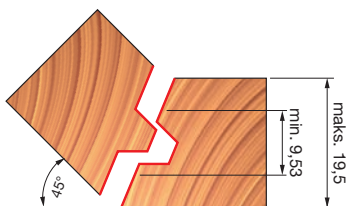
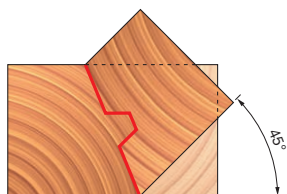

Reversibel klæbesamlingsfræser 99-

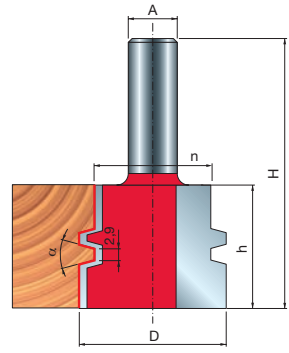
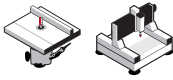

D	h	H	n	A	α	Z	Maks. omdr./min.	Freud-kode	Art.nr.
mm	mm	mm	mm	mm	tomme		1/min.		
38	32	70	30,2	12	15°	2	16.000	99-03112P	F03FR02422
38	32	70	30,2	1/2	15°	2	16.000	99-03150P	F03FR02423

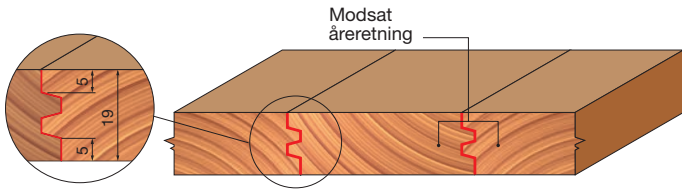

Fingersamlingsfræser 99-

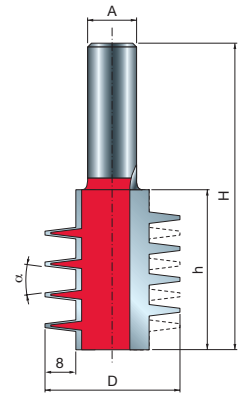
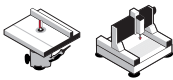



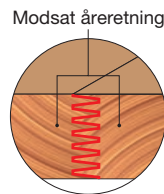
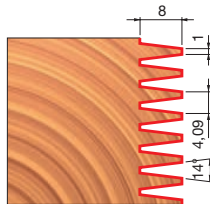

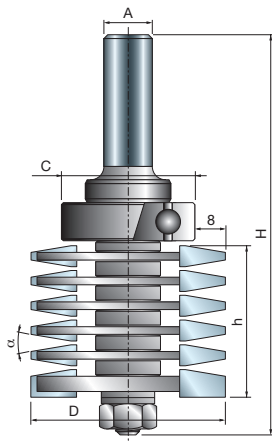

D	h	H	A	α	Z	Maks. omdr./min.	Freud-kode	Art.nr.
mm	mm	mm	mm	mm	mm	1/min.		
35	41,5	79,5	12	14°	2	16.000	99-03712P	F03FR02440



Fingersamlingsfræser med topleje - Type A 99-



D	h	H	A	C	α	Z	Maks. omdr./min.	Freud-kode	Art.nr.
50,8	45,2	108	12	35	20°	2	24.000	99-03912P	F03FR02444



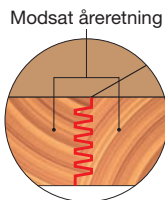
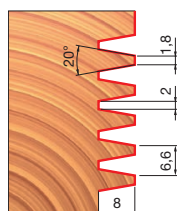

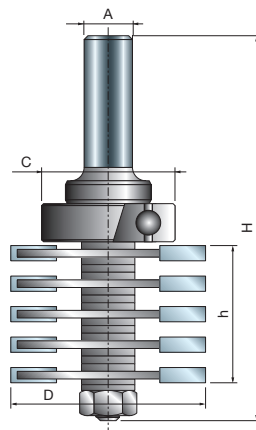

	Reserve dele	Dimensioner mm	Freud-kode	Art.nr.
	Hex-møtrik	7,94 x 6,75	2610M BB9	F03F010003
	Spændeskive	14 x 8,4 x 1,6	2617M BG9	F03FR01668
	Kugleleje	35 x 15 x 11	3102M AI9	F03F012285
	Afstandsholder	18 x 0,1 x 8	AN01MP0019	F03FC00392
	Afstandsholder	18 x 1 x 8	AN01MP0109	F03FC00396
	Afstandsholder	18 x 2,5 x 8	AN01MP0259	F03FC00398
	Afstandsholder	18 x 4,4 x 8	AN01MP0449	F03FC00399



Fingersamlingsfræser med topleje - Type B 99-



D	h	H	A	C	Z	Maks. omdr./min.	Freud-kode	Art.nr.
mm	mm	mm	mm	mm		1/min.		
47	36	101	12	28	2	24.000	99-04212P	F03FR02447

	Reserve dele	Dimensioner mm	Freud-kode	Art.nr.
	Hex-møtrik	7,94 x 6,75	2610M BB9	F03F010003
	Spændeskive	14 x 8,4 x 1,6	2617M BG9	F03FR01668
	Kugleleje	28 x 12 x 8	3102M AH9	F03F010013
	Afstandsholder	18 x 0,2 x 8	AN01MP0029	F03FC00393
	Afstandsholder	18 x 1 x 8	AN01MP0109	F03FC00396
	Afstandsholder	18 x 0,5 x 8	AN01MP0059	F03FC00395
	Afstandsholder	18 x 4,4 x 8	AN01MP0449	F03FC00399

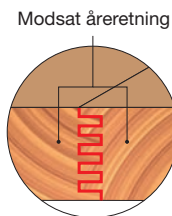
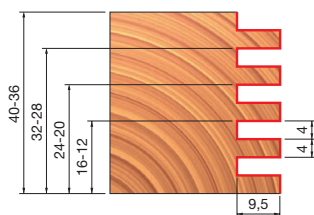

Skuffelåsefræser 99-

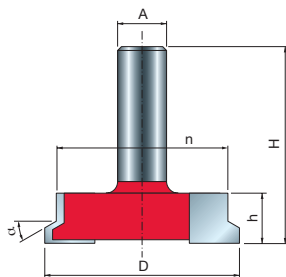

D	h	H	A	n	α	Z	Maks. omdr./min.	Freud-kode	Art.nr.
mm	mm	mm	mm	mm			1/min.		
50,5	13	49	12	44,5	30°	2	16.000	99-24012P	F03FR02463

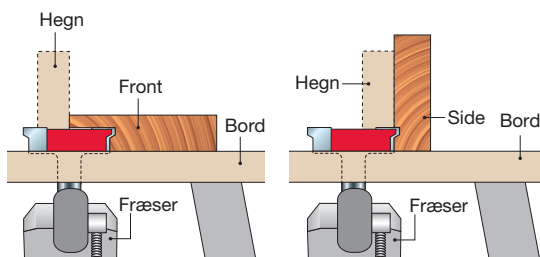
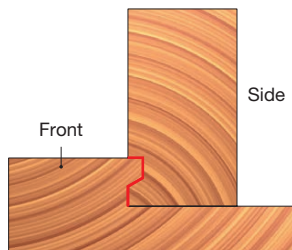
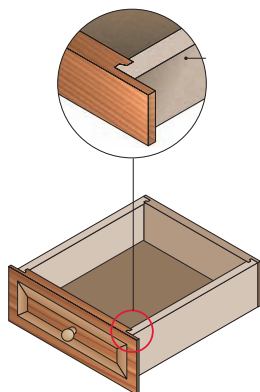

Dørtrækfræser 99-

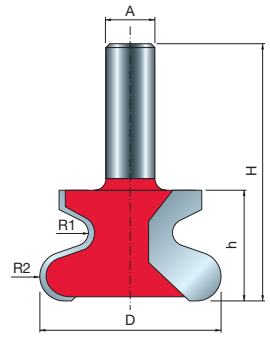

D	h	H	A	R1	R2	Z	Maks. omdr./min.	Freud-kode	Art.nr.
mm	mm	mm	mm	mm	mm		1/min.		
47	28,7	66,7	12	3,2	6,35	2	16.000	99-00712P	F03FR02413

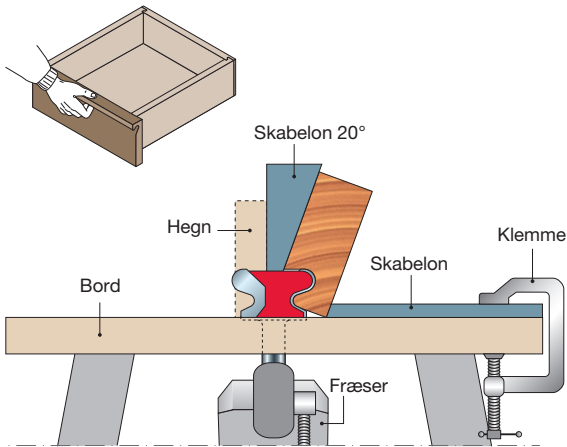
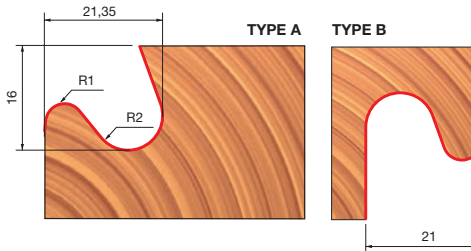

Tilhørende profil og markeringsfræser 99-



D	H	A	R1	R2	C	Z	Maks. omdr./min.	Freud-kode	Art.nr.
mm	mm	mm tomme	mm	mm	mm		1/min.		
42,9	77	12	5,5	-	22	2	24.000	99-26012P	F03FR02468
42,9	77	12	4,5	5,5	22	2	24.000	99-26112P	F03FR02478
42,9	77	12	7	-	22	2	24.000	99-26312P	F03FR02488
42,9	77	1/2	4,5	5,5	22	2	24.000	99-26150P	F03FR02483
42,9	77	1/2	7	-	22	2	24.000	99-26350P	F03FR02493

Reserve dele	Dimensioner mm	Freud-kode	Art.nr.
	Hex-møtrik	7,94 x 6,75	2610M BB9 F03F010003
	Afstandsholder	18 x 0,1 x 8	AN01MP0019 F03FC00392
	Afstandsholder	18 x 0,2 x 8	AN01MP0029 F03FC00393
	Afstandsholder	18 x 0,5 x 8	AN01MP0059 F03FC00395
	Afstandsholder	18 x 1 x 8	AN01MP0109 F03FC00396
	Kugleleje	22 x 8 x 7,1	3102M AC9 F03F010008

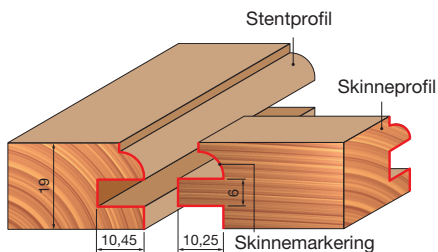
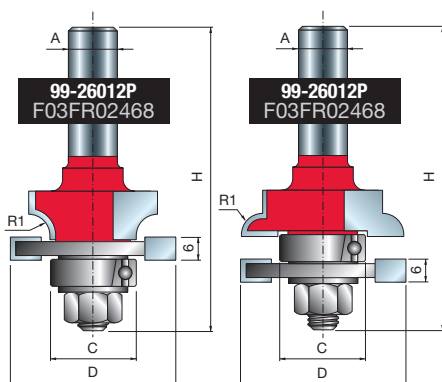

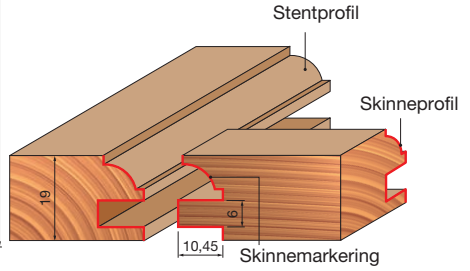
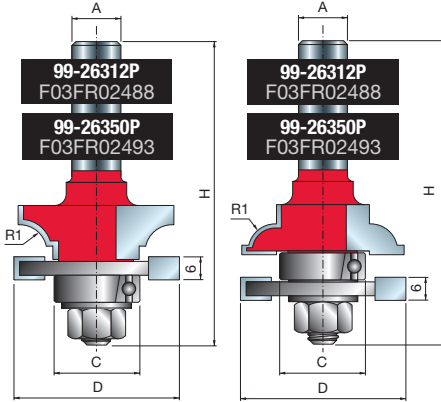
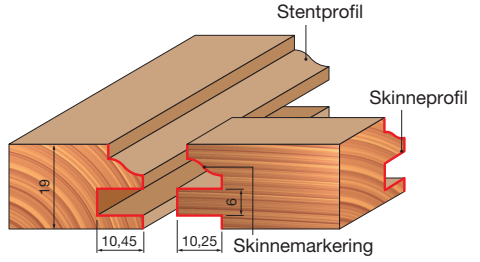
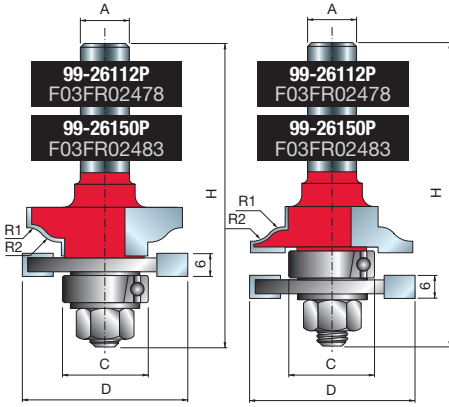





Tilhørende profil og markeringsfræser 99-



D	h	H	A	R1	R2	C	Z	Maks. omdr./min.	Freud-kode	Art.nr.
mm	mm	mm	mm tomme	mm	mm	mm		1/min.		
50,4	32,7	104	12	5,5	-	32	2	14.000	99-29012P	F03FR02494
50,4	32,7	104	12	5,5	4,5	32	2	14.000	99-29112P	F03FR02496
50,4	32,7	104	12	7	-	32	2	14.000	99-29312P	F03FR02498
50,4	32,7	104	1/2	5,5	-	32	2	14.000	99-29050P	F03FR02495
50,4	32,7	104	1/2	7	-	32	2	14.000	99-29350P	F03FR02499

Reserve dele	Dimensioner mm	Freud-kode	Art.nr.
 Hex-møtrik	7,94 x 6,75	2610M BB9	F03F010003
 Spændering	15 x 13,9	2621ME 015	F03FA07444
 Kugleleje	32 x 15 x 9	3102M AN9	F03F010016
 Afstandsholder	18 x 1 x 8	AN01MP0109	F03FC00396

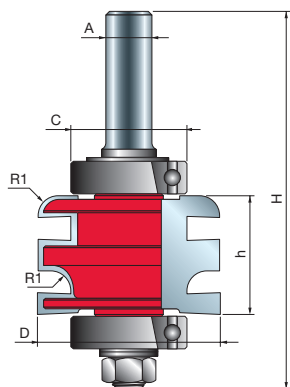

99-29012P
F03FR02494

99-29050P
F03FR02495

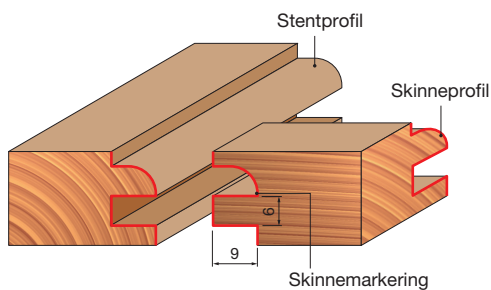

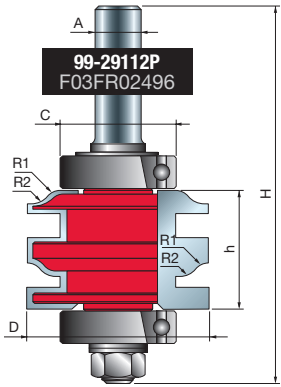

99-29112P
F03FR02496

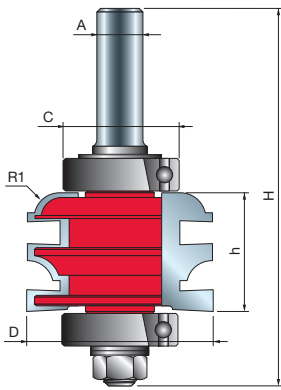
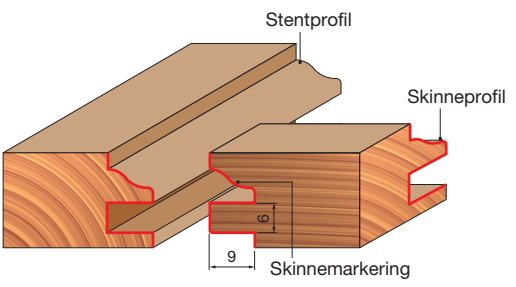

99-29312P
F03FR02498



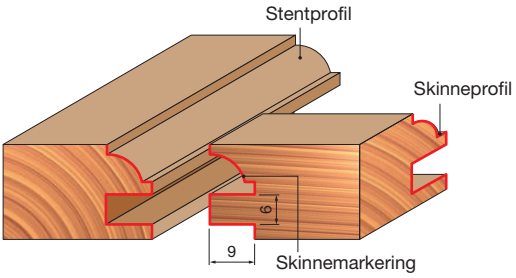

99-29350P
F03FR02499



Vinduesfræser 99-



D	h	H	A	m	C	R	Z	Maks. omdr./min.	Freud-kode	Art.nr.
mm	mm	mm	mm	mm	mm	mm		1/min.		
34	35,9	78,4	12	14,5	22	6	2	16.000	99-05112P	F03FR02455
38	15,5	53,5	12	-	-	6	2	16.000	99-05012P	F03FR02451

	Reserve dele	Dimensioner mm	Freud-kode	Art.nr.
	Hex-møtrik	7,94 x 6,75	2610M BB9	F03F010003
	Spændeskive	14 x 8,4 x 1,6	2617M BG9	F03FR01668
	Kugleleje	22 x 8 x 7,1	3102M AC9	F03F010008
	Afstandsholder	18 x 0,1 x 8	AN01MP0019	F03FC00392

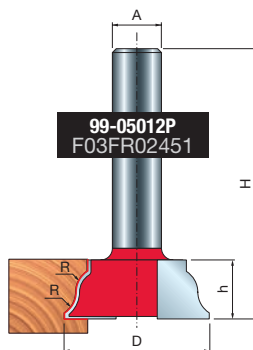
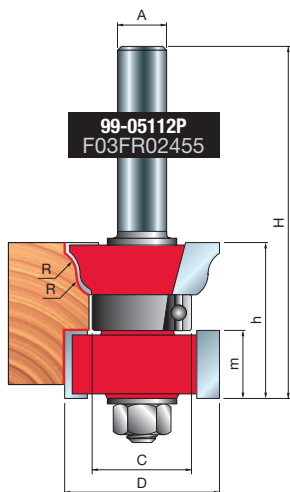

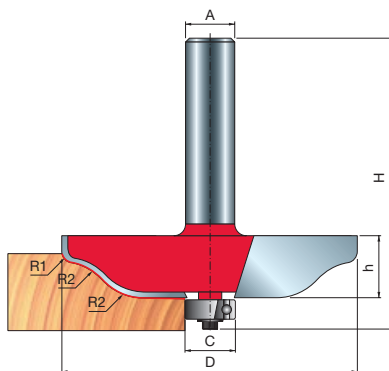

Forhøjet panelfræser 99-



Type A

D	h	H	A	C	R1	R2	Z	Maks. omdr./min.	Freud-kode	Art.nr.
mm	mm	mm	mm	tomme	mm	mm	mm	1/min.		
76,2	16	64,7	12	12,7	2	16	2	12.000	99-22112P	F03FR02458
70	16	64,5	1/2	12,7	14	3	4	12.000	99-51050P	F03FR02504
89	16	64,5	1/2	12,7	20	4	4	10.000	99-52050P	F03FR02512

	Reserve dele	Dimensioner mm	Freud-kode	Art.nr.
	Skrue	M3 x 7,6	2607M 001	F03F010000
	Kugleleje	12,7 x 4,98 x 4,76	3102M AB9	F03F010007
	Spændeskive	12 x 1,1 x 4,8	FX07M AB9	F03F010159

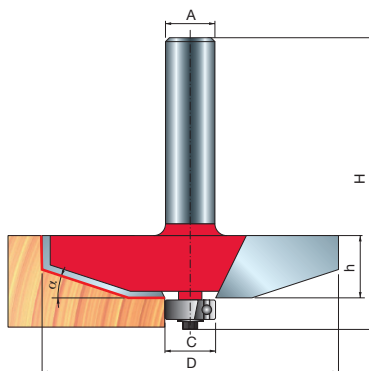

Type B

D	h	H	A	C	α	Z	Maks. omdr./min.	Freud-kode	Art.nr.
mm	mm	mm	mm	tomme	mm	mm	1/min.		
76,2	16	64,7	12	12,7	2	2	12.000	99-22112P	F03FR02458
70	16	64,5	1/2	12,7	14	4	12.000	99-51050P	F03FR02504
89	16	64,5	1/2	12,7	20	4	10.000	99-52050P	F03FR02512

Til reservedele se venligst **Type A** bord.

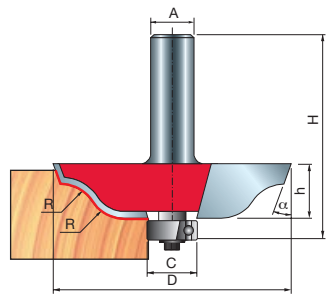

Type C

D	h	H	A	C	α	R	Z	Maks. omdr./min.	Freud-kode	Art.nr.
mm	mm	mm	tomme	mm		mm		1/min.		
70	16	64,5	1/2	12,7	20°	11	4	12.000	99-51350P	F03FR02507

Til reservedele se venligst **Type A** bord.

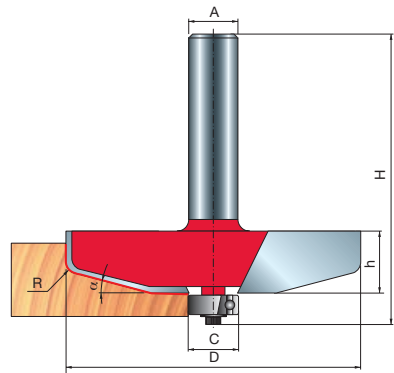

Type D

D	h	H	A	C	α	R	Z	Maks. omdr./min.	Freud-kode	Art.nr.
mm	mm	mm	tomme	mm		mm		1/min.		
76,2	16	60	12	12,7	15°	4,8	2	12.000	99-22412P	F03FR02461

Til reservedele se venligst **Type A** bord.

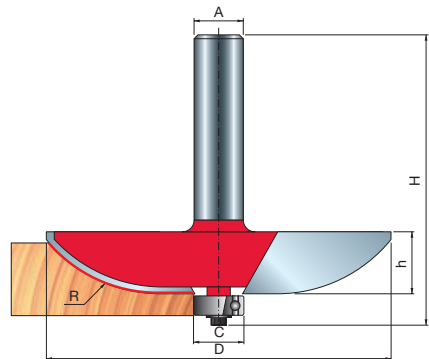

Type E

D	h	H	A	C	R	Z	Maks. omdr./min.	Freud-kode	Art.nr.	
mm	mm	mm	mm	tomme	mm	mm	1/min.			
89	16	64,7	12		12,7	38,1	2	10.000	99-22512P	F03FR02462
89	16	64,5		1/2	12,7	38	4	10.000	99-51850P	F03FR02510

Til reservedele se venligst **Type A** bord.

Forhøjet panelfræser med bagskærer

99-



D	h	H	A	α	R1	R2	Z	Maks. omdr./min.	Freud-kode	Art.nr.
mm	mm	mm	mm		mm	mm		1/min.		
89	25	75	12	15°	6	-	2	14.000	99-56612P	F03FR02515
89	25	75	12	15°	38	6	2	14.000	99-56912P	F03FR02523
89	25	75	12	15°	30	6	2	14.000	99-57112P	F03FR02529

Reserve dele	Dimensioner mm	Freud-kode	Art.nr.
	Hex-møtrik	7,94 x 6,75	2610M BB9 F03F010003
	Afstandsholder	18 x 0,1 x 8	AN01MP0019 F03FC00392
	Afstandsholder	18 x 0,2 x 8	AN01MP0029 F03FC00393
	Afstandsholder	18 x 0,5 x 8	AN01MP0059 F03FC00395
	Afstandsholder	18 x 1 x 8	AN01MP0109 F03FC00396
	Afstandsholder	18 x 0,15 x 8	AN01MPAA99 F03FC00391

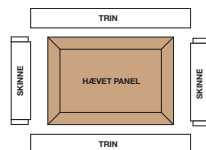
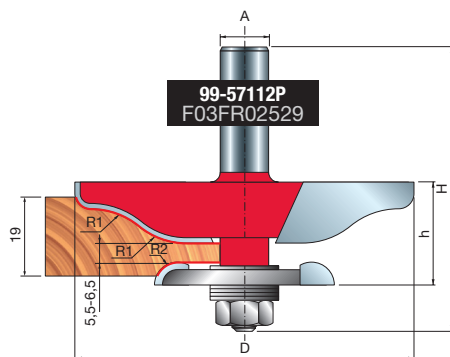
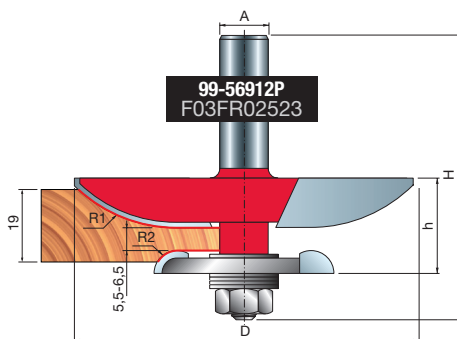
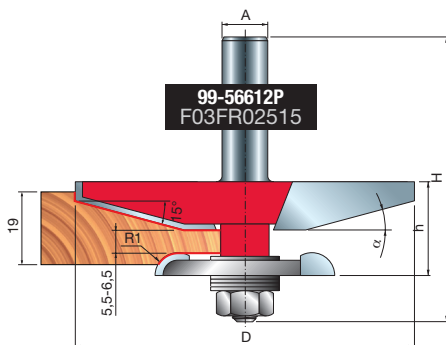

Lodret forhøjet panelfræser 99-

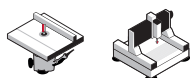

D	h	H	A	α	R1	R2	Z	Maks. omdr./min.	Freud-kode	Art.nr.
mm	mm	mm	mm		mm	mm		1/min.		
31,8	41,5	79,5	12	-	2	16	2	16.000	99-32212P	F03FR02500
31,8	41,5	79,5	12	18°	-	-	2	16.000	99-32312P	F03FR02501
31,8	41,5	79,5	12	15°	4,8	-	2	16.000	99-32412P	F03FR02502
31,8	41,5	79,5	12	-	38,1	-	2	16.000	99-32512P	F03FR02503

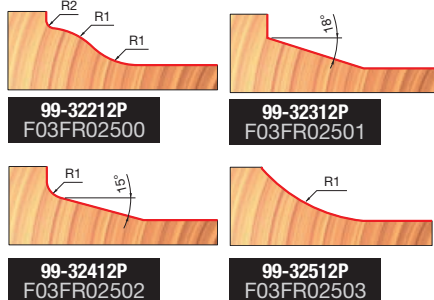
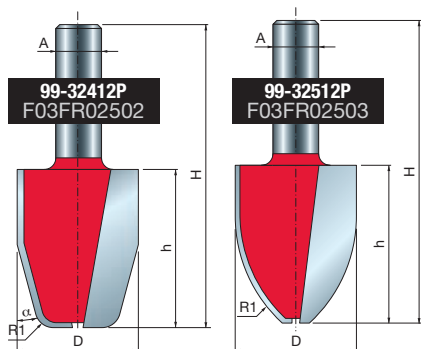
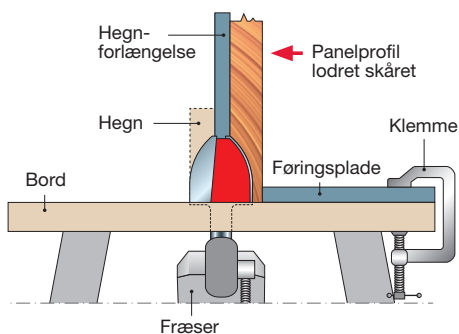
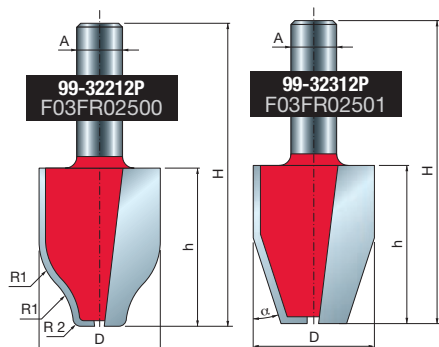

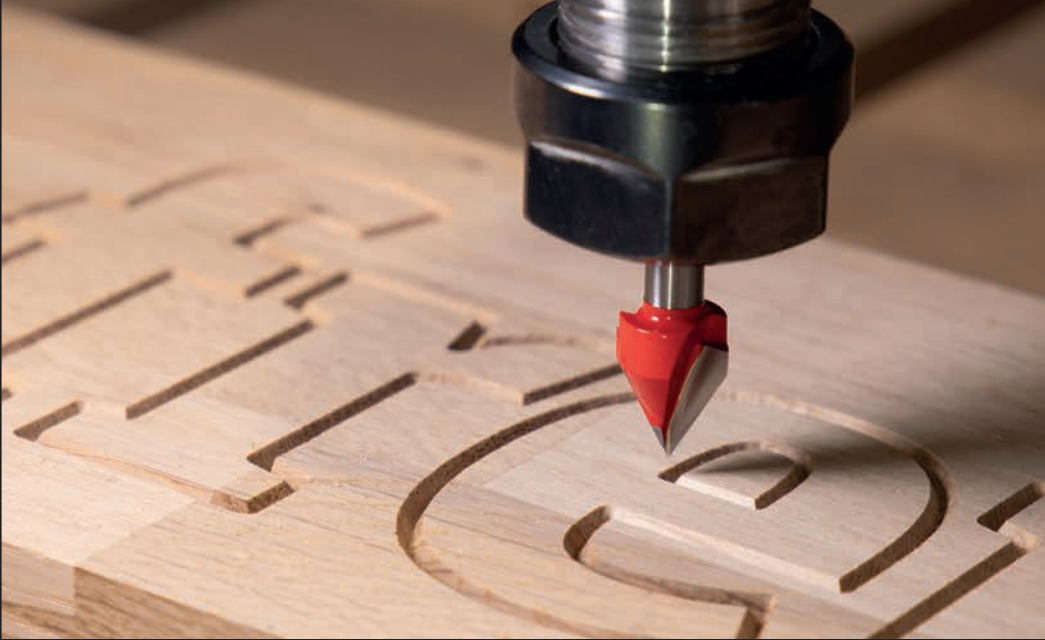

OVERFLADEFRÆSERE

V-notfræser 20- PI01

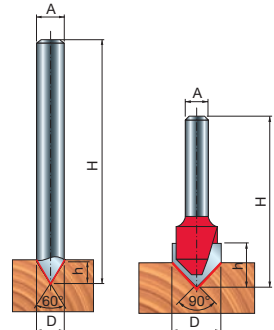
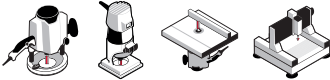

D	h	H	A	α	Z	Maks. omdr./min.	Freud-kode	Art.nr.
mm	mm	mm	mm	tomme		1/min.		
• 6	6	38,1	6	90°	1	24.000	20-10006P	F03FR01617
9,5	10	44,4	6	90°	2	24.000	20-10206P	F03FR01619
12,7	10	44,4	6	90°	2	24.000	20-10406P	F03FR01622
12,7	12,7	49,2	6	60°	2	24.000	20-15206P	F03FR01629
12,7	11	57,3	6	60°	3	24.000	20-15406P	F03FR01632
• 6	6	38,1	8	90°	1	24.000	20-10008P	F03FR01618
• 8	6	70	8	60°	1	30.000	PI01MD6083	F03FR00382
• 8	8	70	8	60°	1	24.000	20-16008P	F03FR01634
9,5	10	44,4	8	90°	2	24.000	20-10208P	F03FR01620
12,7	10	44,4	8	90°	2	24.000	20-10408P	F03FR01623
12,7	12,7	50,8	8	60°	2	24.000	20-15208P	F03FR01630
12,7	11	54	8	60°	3	24.000	20-15408P	F03FR01633

D	h	H	A	α	Z	Maks. omdr./min.	Freud-kode	Art.nr.
mm	mm	mm	mm tomme			1/min.		
31,75	16	51	8	90°	2	24.000	20-91408P	F03FR02857
15,88	12,5	56,5	12	90°	2	24.000	20-10612P	F03FR01625
19,05	12,5	57,2	12	90°	2	24.000	20-10812P	F03FR01626
9,53	10	44,4	1/4	90°	2	24.000	20-10225P	F03FR01621
12,7	10	44,4	1/4	90°	2	24.000	20-10425P	F03FR01624
12,7	12,7	47,5	1/4	60°	2	24.000	20-15225P	F03FR01631
12,7	12,7	54,7	1/2	90°	2	24.000	20-10950P	F03FR01628

• Hårdmetalfræsere

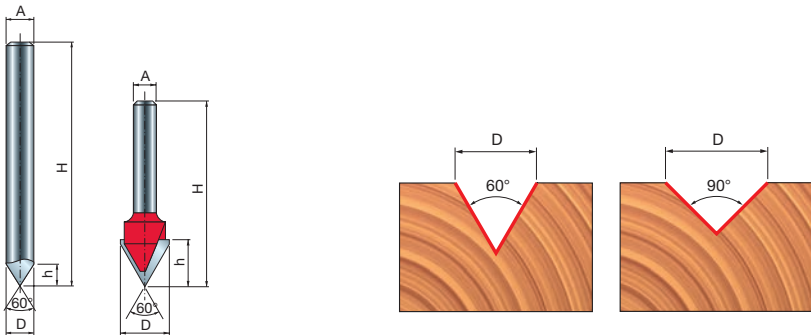

Hårdmetalfræsere

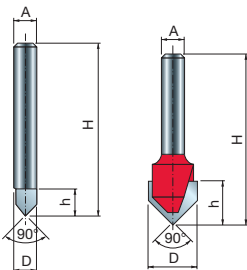

Hårdmetalfræsere

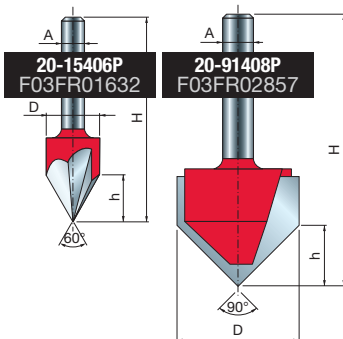

V-notfræser til ACM-panelfoldning 21-

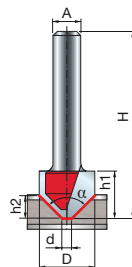
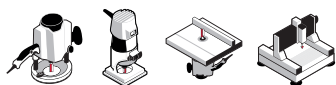

D	h1	h2	H	A	C	α	Z	Maks. omdr./min.	Freud-kode	Art.nr.
mm	mm	mm	mm	mm tomme	mm			1/min.		
16	12,5	6,8	50,8	6	2,5	90°	2	24.000	21-11206P	F03FR04018
19,05	12,5	6	50,8	6	2,5	108°	2	24.000	21-14606P	F03FR04021
22,23	12,5	4,2	50,8	6	2,29	135°	2	24.000	21-18206P	F03FR04024
16	12,5	6,8	50,8	8	2,5	90°	2	24.000	21-11208P	F03FR04019
19,05	12,5	6	50,8	8	2,5	108°	2	24.000	21-14608P	F03FR04022
22,23	12,5	4,2	50,8	8	2,29	135°	2	24.000	21-18208P	F03FR04025
12,7	10,8	5,2	50,8	1/4	2,29	90°	2	24.000	21-11025P	F03FR04017
16	12,7	6,8	50,8	1/4	2,5	90°	2	24.000	21-11225P	F03FR04020
19,05	12,7	6	50,8	1/4	2,5	108°	2	24.000	21-14625P	F03FR04023
22,23	12,7	4,2	50,8	1/4	2,29	135°	2	24.000	21-18225P	F03FR04026

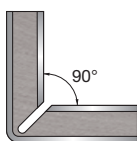

$\alpha = 90^\circ$

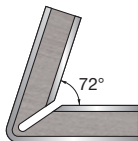

$\alpha = 108^\circ$

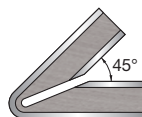

$\alpha = 135^\circ$

Rektangulær fræser med rille til ACM-panelfoldning 21-

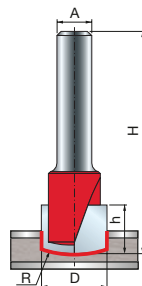
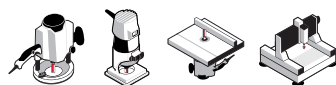

D	h	H	A	R	Z	Maks. omdr./min.	Freud-kode	Art.nr.
mm	mm	mm	mm tomme	mm		1/min.		
15,88	11	50	8	23,8	2	24.000	21-20008P	F03FR03967
15,88	11	50,8	1/4	23,8	2	24.000	21-20025P	F03FR03963

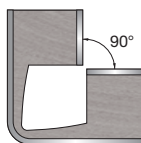

Skriftfræser

20-

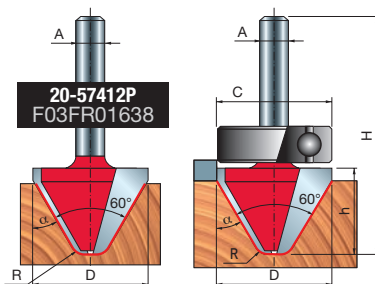
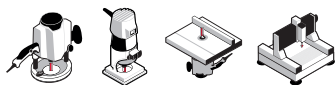

D	h	H	A	C	R	α	Z	Maks. omdr./min.	Freud-kode	Art.nr.
mm	mm	mm	mm	mm	mm			1/min.		
25,4	19	51,05	6	-	3	60°	2	24.000	20-17206P	F03FR01635
25,4	19	51,05	8	-	3	60°	2	24.000	20-17208P	F03FR01636
28,57	19	57	12	-	3	60°	2	18.000	20-17412P	F03FR01637
28	19	67,15	12	28	3	60°	2	18.000	20-57412P	F03FR01638

Hulkelsfræser

18-

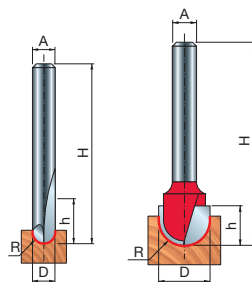
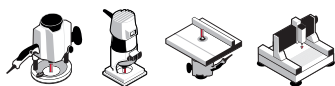

D	h	H	A	R	Z	Maks. omdr./min.	Freud-kode	Art.nr.
mm	mm	mm	mm	tomme	mm	1/min.		
• 3,2	9,5	50,5	6	1,6	2	24.000	18-10006P	F03FR01581
• 4,8	9,5	50,5	6	2,4	2	24.000	18-10206P	F03FR01584
• 6	12,7	50,8	6	3	2	24.000	18-10406P	F03FR01587
9,52	9	46	6	4,8	2	24.000	18-10606P	F03FR01590
12	9	46	6	6	2	24.000	18-10806P	F03FR01593
15,88	11	50,8	6	8	2	24.000	18-11006P	F03FR01596
19,05	11	50,8	6	9,5	2	24.000	18-11206P	F03FR01599
• 3,2	9,5	50,5	8	1,6	2	24.000	18-10008P	F03FR01582
• 4,8	9,5	50,5	8	2,4	2	24.000	18-10208P	F03FR01585
• 6	12,7	50,8	8	3	2	24.000	18-10408P	F03FR01588
9,52	9	46	8	4,8	2	24.000	18-10608P	F03FR01591
12	9	46	8	6	2	24.000	18-10808P	F03FR01594
15,88	11	50,8	8	8	2	24.000	18-11008P	F03FR01597
19,05	11	50,8	8	9,5	2	24.000	18-11208P	F03FR01600
• 6	9,5	57	12	3	2	24.000	18-11412P	F03FR01602
12,7	31,7	71,5	12	6,35	2	24.000	18-11612P	F03FR01604
19,05	31,7	73	12	9,5	2	24.000	18-12212P	F03FR01606
25,4	31,7	73	12	12,7	2	24.000	18-12612P	F03FR01608
• 3,18	9,5	50,5	1/4	1,59	2	24.000	18-10025P	F03FR01583

D	h	H	A	R	Z	Maks. omdr./min.	Freud-kode	Art.nr.
mm	mm	mm	mm	tomme	mm	1/min.		
• 4,76	6,4	50,5	1/4	2,38	2	24.000	18-10225P	F03FR01586
• 6,35	12,7	50,5	1/4	3,18	2	24.000	18-10425P	F03FR01589
9,52	9	45	1/4	4,77	2	24.000	18-10625P	F03FR01592
12,7	9	45,5	1/4	6,35	2	24.000	18-10825P	F03FR01595
15,88	11	48	1/4	7,94	2	24.000	18-11025P	F03FR01598
19,05	11	48	1/4	9,53	2	24.000	18-11225P	F03FR01601
6,35	12,7	61	1/2	3,18	2	24.000	18-11450P	F03FR01603
12,7	31,7	72,7	1/2	6,35	2	24.000	18-11650P	F03FR01605
19	31,7	73	1/2	9,5	2	24.000	18-12250P	F03FR01607

- Hårdmetalfræsere

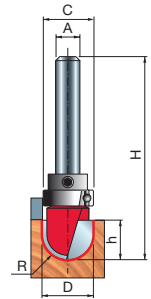

Fræsere med kugleleje (ikke egnet til CNC-maskiner)

D	h	H	A	R	C	Z	Maks. omdr./min.	Freud-kode	Art.nr.
mm	mm	mm	mm	mm	mm	mm	1/min.		
15,88	11	59,5	6	8	15,8	2	24.000	18-51006P	F03FR01609
19,05	11,1	59,5	6	9,5	19	2	24.000	18-51206P	F03FR01611
15,88	11	59,5	8	8	15,8	2	24.000	18-51008P	F03FR01610
19,05	11	59,5	8	9,5	19,05	2	24.000	18-51208P	F03FR01612

Træskålfræsere 19- 99-

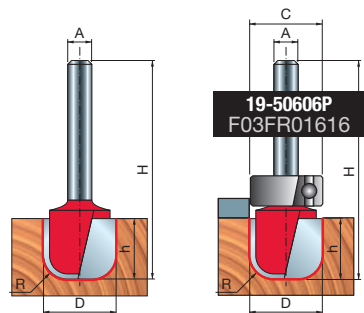
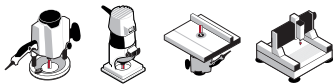

D	h	H	A	R	C	Z	Maks. omdr./min.	Freud-kode	Art.nr.
mm	mm	mm	mm	mm	mm	mm	1/min.		
19	15,9	64,1	6	6,35	19	2	24.000	19-50606P	F03FR01616
19,05	15,9	47,5	6	6,35	-	2	24.000	19-10606P	F03FR01613
19,05	15,9	47,5	8	6,35	-	2	24.000	19-10608P	F03FR01614
19,05	15,9	67	12	6,35	-	2	24.000	19-12612P	F03FR01615
31,75	15,8	53	12	6,35	-	2	18.000	99-02612P	F03FR02420

Ovolo fræser

39-

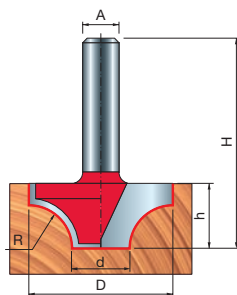
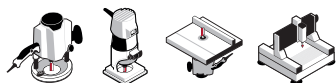

D	h	H	A	R	d	Z	Maks. omdr./min.	Freud-kode	Art.nr.
mm	mm	mm	mm	mm	mm		1/min.		
12,7	8	40	6	3,2	6,35	2	24.000	39-20206P	F03FR01871
24,7	12,7	44,7	8	6	12,7	2	24.000	39-20908P	F03FR01873
31,75	14,3	46,3	8	9,53	12,7	2	18.000	39-20808P	F03FR01872
63,5	33,3	71,3	12	25,4	12,7	2	12.000	39-23812P*	F03FR01874

* Ikke egnet til håndholdte maskiner.

Dobbelt rillefræser med fordybning og forhøjning

39-

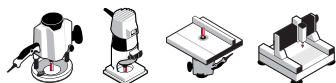

D	h	H	A	C	R1	R2	R3	Z	Maks. omdr./min.	Freud-kode	Art.nr.
mm	mm	mm	mm	mm	mm	mm	mm		1/min.		
39,6	13	45	6	-	7,9	4,2	3,4	2	16.000	39-60006P	F03FR01896
39,6	13	60,1	6	39,6	7,9	4,2	3,4	2	16.000	39-65006P	F03FR01898
39,6	13	45	8	-	7,9	4,2	3,4	2	16.000	39-60008P	F03FR01897
39,6	13	60,1	8	39,6	7,9	4,2	3,4	2	16.000	39-65008P	F03FR01899

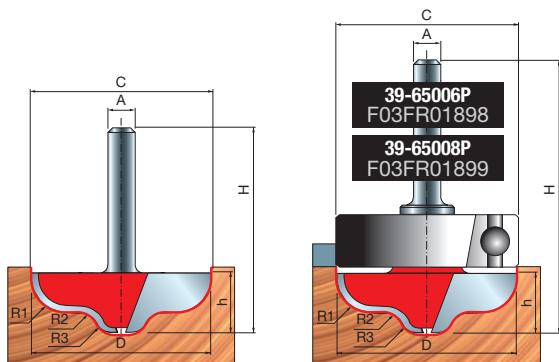

Rillefræser med dobbelt fordybning og topleje

39-

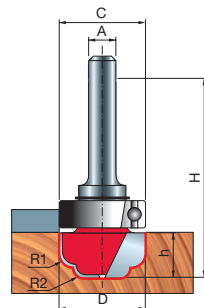

D	h	H	A	C	R1	R2	Z	Maks. omdr./min.	Freud-kode	Art.nr.
mm	mm	mm	mm	mm	mm	mm		1/min.		
19	9,6	53	6	19	3,2	2,4	2	24.000	39-51206P	F03FR01887

Notfræser med fordybning og forhøjning

39-

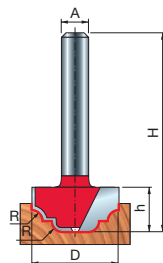
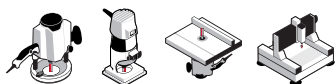

D	h	H	A	R	Z	Maks. omdr./min.	Freud-kode	Art.nr.	
mm	mm	mm	mm	tomme	mm	1/min.			
19,05	9,8	41,8	6	2,38	2	24.000	39-10006P	F03FR01856	
25,4	12,7	44,7	6	3,18	2	24.000	39-10206P	F03FR01860	
19,05	9,8	41,8	8	2,38	2	24.000	39-10008P	F03FR01857	
19	12,7	44,7	8	4	2	24.000	39-10108P	F03FR01859	
25,4	12,7	44,7	8	3,18	2	24.000	39-10208P	F03FR01861	
31,75	12,7	44,7	8	4	2	18.000	39-11408P	F03FR01863	
31,75	12,7	50,7	12	4	2	18.000	39-11412P	F03FR01864	
19,05	9,8	41,8		1/4	2,38	2	24.000	39-10025P	F03FR01858
25,4	12,7	44,7		1/4	3,18	2	24.000	39-10225P	F03FR01862

Klassisk notfræser med forhøjning 39-

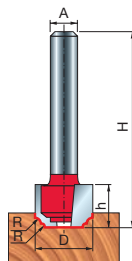
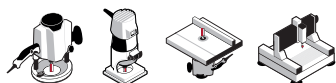

D	h	H	A	R	Z	Maks. omdr./min.	Freud-kode	Art.nr.	
mm	mm	mm	mm	tomme	mm	1/min.			
12,7	9,5	41,2	6		1,2	2	24.000	39-30206P	F03FR01878
15,88	9,5	41,2	6		2,38	2	24.000	39-30406P	F03FR01881
22,22	12	43,7	6		3,18	2	24.000	39-30606P	F03FR01884
12,7	9,5	41,2	8		1,2	2	24.000	39-30208P	F03FR01879
15,88	9,5	41,2	8		2,38	2	24.000	39-30408P	F03FR01882
22,22	12	43,7	8		3,2	2	24.000	39-30608P	F03FR01885
12,7	9,5	41,2		1/4	1,2	2	24.000	39-30225P	F03FR01880
15,88	9,5	41,2		1/4	2,38	2	24.000	39-30425P	F03FR01883
22,22	12	43,7		1/4	3,18	2	24.000	39-30625P	F03FR01886

S-profil notfræser 39-

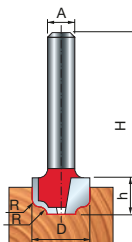
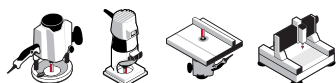

D	h	H	A	R	Z	Maks. omdr./min.	Freud-kode	Art.nr.	
mm	mm	mm	mm	tomme	mm	1/min.			
12,7	8	40	6		1,59	2	24.000	39-15206P	F03FR01865
19,05	12,7	44,7	6		6,35	2	24.000	39-24006P	F03FR01875
22,23	10,36	42,4	6		3,18	2	24.000	39-15406P	F03FR01868
12,7	8	40	8		1,6	2	24.000	39-15208P	F03FR01866
19,05	12,7	44,7	8		6,4	2	24.000	39-24008P	F03FR01876
22,23	10,36	42,4	8		3,2	2	24.000	39-15408P	F03FR01869
19,05	12,7	50,7	12		6,4	2	24.000	39-24012P	F03FR01877
12,7	8	40		1/4	1,59	2	24.000	39-15225P	F03FR01867
22,23	10,4	42,4		1/4	3,18	2	24.000	39-15425P	F03FR01870

Fræsere med fordybning og forhøjning og topleje 39-

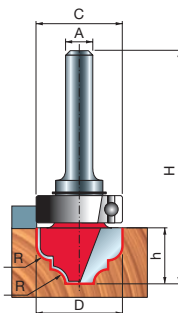

D	h	H	A	C	R	Z	Maks. omdr./min.	Freud-kode	Art.nr.	
mm	mm	mm	mm	tomme	mm	mm	1/min.			
19	12,7	55,5	6		19	3,18	2	24.000	39-53206P	F03FR01892
28	14	58,1	8		28	3,18	2	18.000	39-53808P	F03FR01894
28	14	64,1	12		28	3,18	2	18.000	39-53812P	F03FR01895
19	12,7	55,5		1/4	19	3,18	2	24.000	39-53225P	F03FR01893

S-profil notfræsere med trinformat detalje og topleje 39-

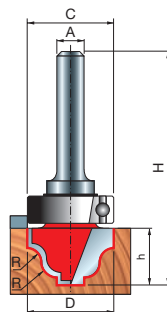

D	h	H	A	C	R	Z	Maks. omdr./min.	Freud-kode	Art.nr.	
mm	mm	mm	mm	tomme	mm	mm	1/min.			
19	12,5	55,5	6		19	3,18	2	24.000	39-52206P	F03FR01888
28	14,4	58,1	8		28	4	2	18.000	39-52808P	F03FR01890
28	14,4	64,1	12		28	4	2	18.000	39-52812P	F03FR01891
19	12,5	55,5		1/4	19	3,18	2	24.000	39-52225P	F03FR01889



BLANDEDE SÆT

Blandede sæt 88- 90- 91- 92-

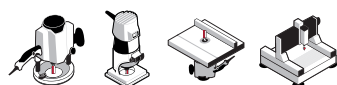

	A	Freud-kode	Art.nr.
	mm		
Grundlæggende 4 fræsesæt	6	88-10606P	F03FR02255
Begynder 6 fræsesæt	8	91-10408P	F03FR02293
Begynder 6 fræsesæt	12	91-10412P	F03FR02294
Mellem 9 fræsesæt	6	88-10206P	F03FR02250
Super 13 fræsesæt	8	91-10008P	F03FR02275
Super 13 fræsesæt	12	91-10012P	F03FR02277
Avanceret 15 fræsesæt	6	90-10006P	F03FR02256
Professional 26 fræsesæt	6	92-10006P	F03FR02308

Skabsdørsæt 3 fræsere

97-

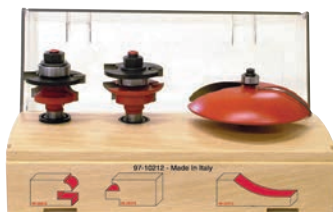

	A	Freud-kode	Art.nr.
	mm		
Forhøjet panelfræser + Tilhørende profil og markeringsfræser	12	97-10212P	F03FR02382

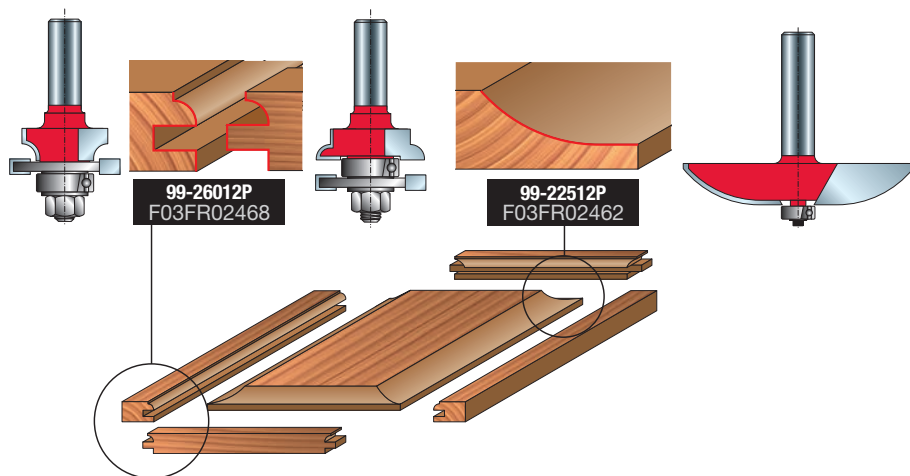

	A	Freud-kode	Art.nr.
	mm		
Forhøjet panelfræser + Tilhørende profil og markeringsfræser	12	97-10412P	F03FR02396

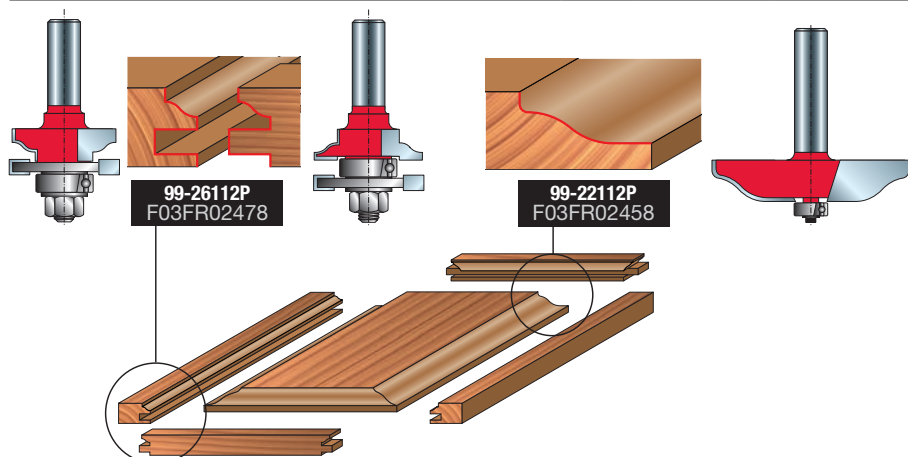

Skabsdørsæt 4 fræsere 95-

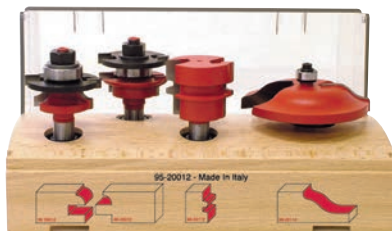

	A	Freud-kode	Art.nr.
	mm		
Forhøjet paneelfræser + Tilhørende profil og markeringsfræser + Reversibel klæbesamlingsfræser	12	95-20012P	F03FR02368



99-26012P
F03FR02468

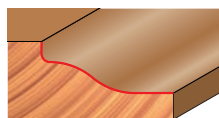
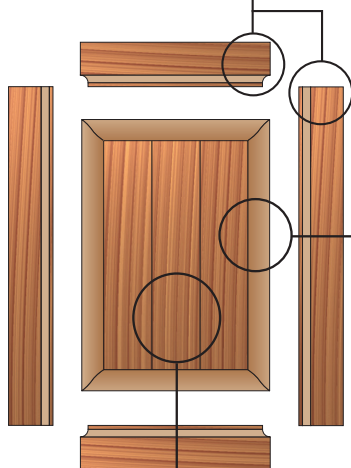

99-22112P
F03FR02458

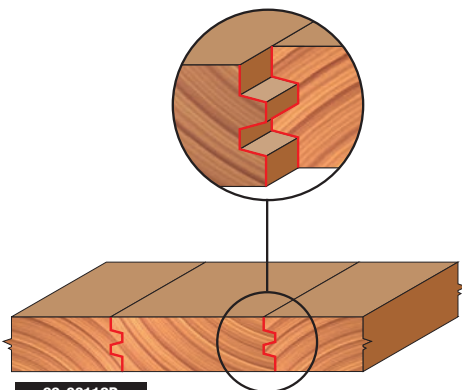
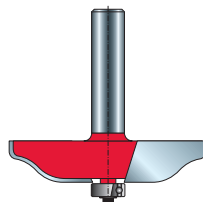

99-03112P
F03FR02422

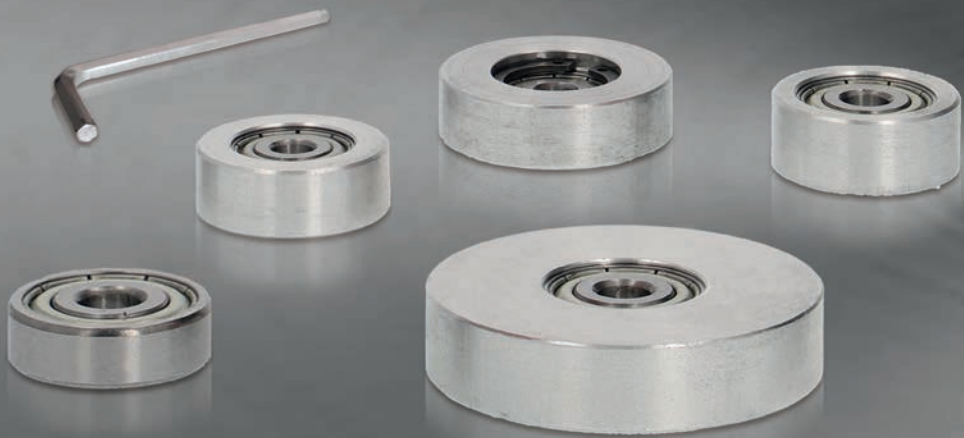

TILBEHØR

Nippelmuffer 3105M

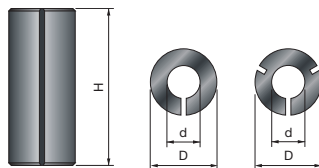

D	H	d	Freud-kode	Art.nr.
mm	mm	mm		
8	25	6	3105MVY250	F03FA10588
8	25	6,35	3105MVX250	F03FA10587
9,5	25	6	3105MUY250	F03FA10586
9,5	25	6,35	3105MUX250	F03FA10585
9,5	25	8	3105MUV250	F03FA10584
10	25	8	3105MTV250	F03FA10582
12	25	6	3105MSY250	F03FA10581
12	25	8	3105MSV250	F03FA10580
12	25	10	3105MST250	F03FA10579
12,7	25	6	3105MRY250	F03FA10578
12,7	25	6,35	3105MRX250	F03FA10577
12,7	25	8	3105MRV250	F03FA10576
12,7	25	9,53	3105MRU250	F03FA10575
16	25	13	3105MOQ250	F03FA10574

Kuglelejer 3102M

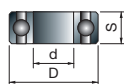

D	S	d	Freud-kode	Art.nr.
mm	mm	mm		
9,53	3,2	4,76	3102M AA9	F03F010006
12	4	6,05	3102M BB9	F03FA10568
12,7	4,98	4,76	3102M AB9	F03F010007
13	5	4	3102M CD9	F03FA14096
13	5	6	3102M AP9	F03FA10558
14	4	8,05	3102M BC9	F03FA10569
15	5	6	3102M AQ9	F03FA10559
15,88	4,98	4,76	3102M AJ9	F03F010014
16	5	5	3102M CC9	F03FA14095
16	5	8	3102M AS9	F03FA10561
19	6	6	3102M CA9	F03FA14097
19	7	10	3102M AG9	F03F010012
19,05	3,97	12,7	3102M CB9	F03FA14098
19,05	6,35	12,7	3102M AV9	F03F012286
22	7	8	3102M AC9	F03F010008
28	8	12	3102M AH9	F03F010013
32	9	15	3102M AN9	F03F010016
35	11	15	3102M AI9	F03F012285

Glidelejer RB62M

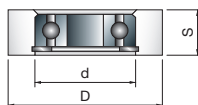

D	S	d	Freud-kode	Art.nr.
mm	mm	mm		
19,05	8	4,8	RB62M 1509	F03F011422
22,22	8	4,8	RB62M 1529	F03F011423
26	10	8	RB62M 1249	F03F011417
28,58	8	4,8	RB62M 1549	F03F011424
30	10	8	RB62M 1289	F03F011418
34	10	8	RB62ME DA9	F03FR01146
34,92	8	4,8	RB62M 1569	F03F011425
39,6	11,2	12	RB62ME FB9	F03FR01147

Glidelejer med vinkel 2103MC

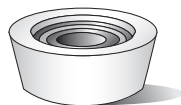
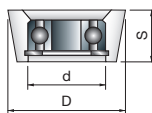

D	S	d	α	Freud-kode	Art.nr.
mm	mm	mm			
19,05	6,35	4,8	10°	3103MC HB9	F03F010019
22,2	9	12,7	15°	3103MC HC9	F03FR01724

KORREKT BRUG OG SIKKERHEDSREGLER

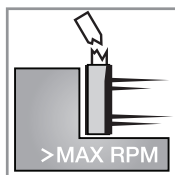

Det maksimale omdrejningstal, der er angivet på fræseren, må ikke overskrides. Højere hastigheder, ekstreme fremføringer og overdrevne skæredybder kan medføre værktøjsnedbrud.

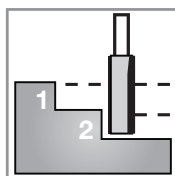

Når du skal fjerne store mængder materiale, kan du udføre flere arbejdsrunder eller arbejde med en fremføringshastighed, der er proportionelt til snitdybden.

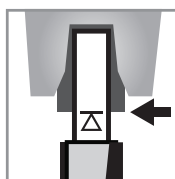

Respekter minimumfremføringsmarkeringen på skaftet.



Fastspænd arbejdsstykket sikkert til arbejdsbordet.

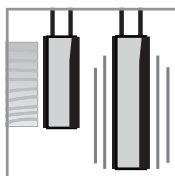

Vælg altid fræsebits med de rette dimensioner til opgaven. En kortere skærer vil vibrere mindre end en længere skærer med samme diameter.

KORREKT BRUG OG SIKKERHEDSREGLER

Regler for fremføringsretning

Bærbar fræsning

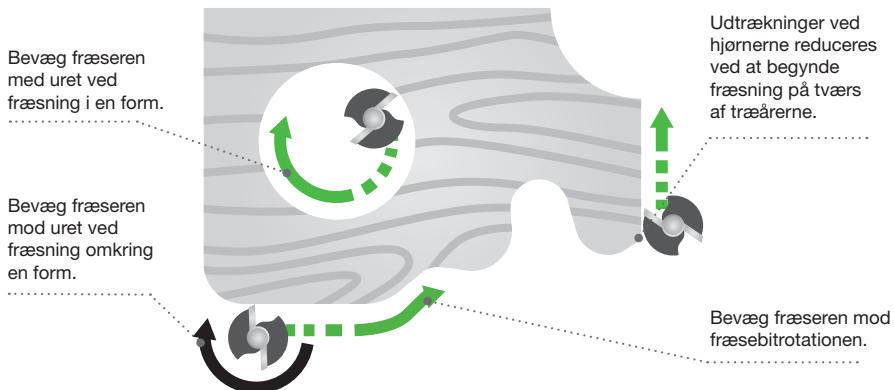

Bordfræsning

Ved bordfræsning fremføres træmønt i modgående retning af bittens rotation.



Problemløsning

Problem	Minimering ▼	Forøgelse ▲
Brændemærker	Omdrejningstal	Fremføringshastighed
Udtrækninger	Fremføringshastighed	Omdrejningstal
Vibrationer	Omdrejningstal Skæredybde	Indstiksdybde af fræser i spændepatron Fiksering af arbejdsemne
Skærebrydning	Fremføringshastighed Skæredybde	Skaftdiameter

Precisely the best

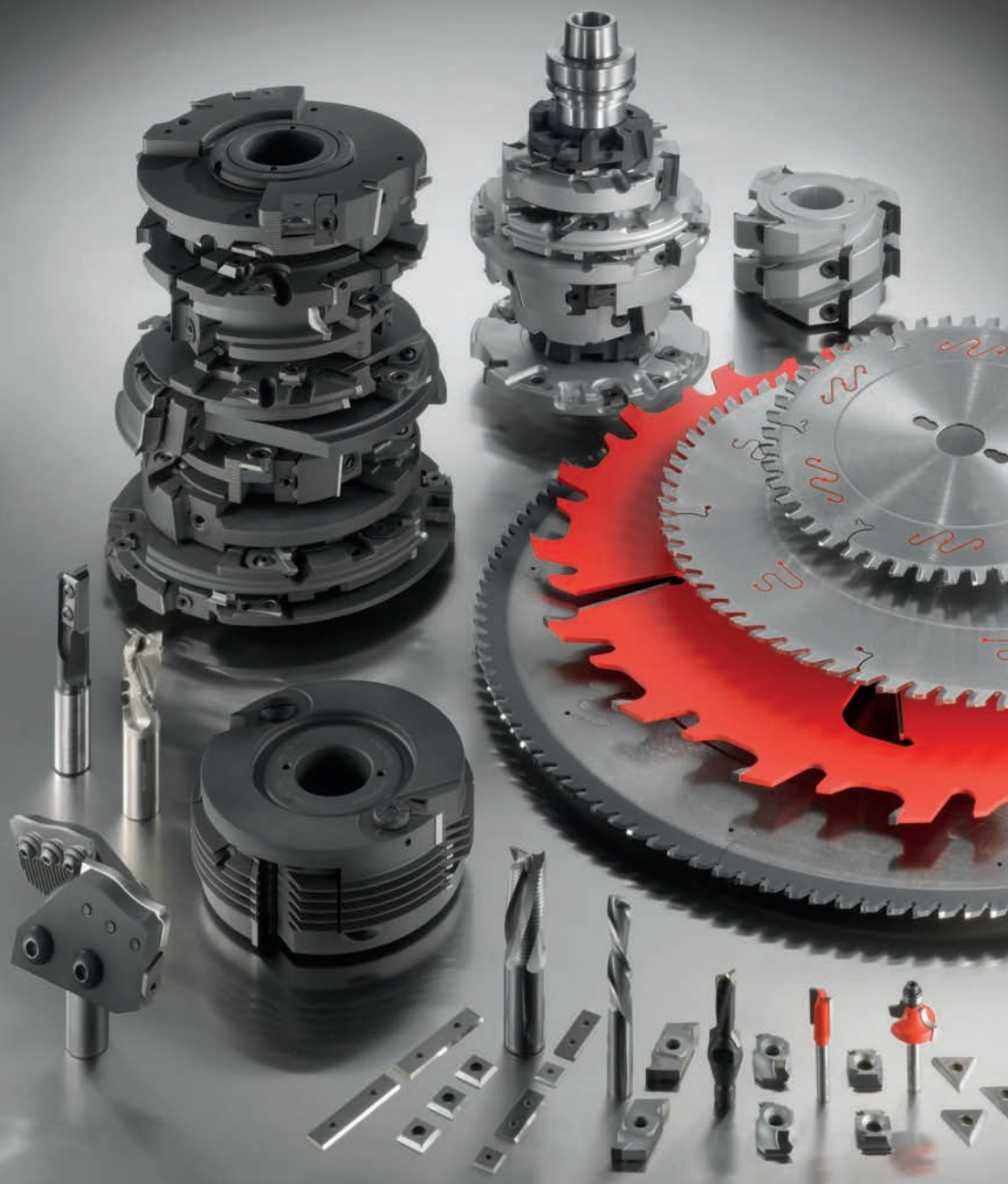



Freud - Førende på det industrielle marked siden 1962

Freud er verdensførende i skæreværktøjsbranchen og den største producent af førsteklasses rundsavklinger. Freud har siden 1962 designet og produceret et omfattende udvalg af førsteklasses rundsavklinger, skærehoveder & loddet skæreværktøj, bore-, fræse- & CNC-værktøjer såvel som knive og tilbehør.

Freud-teknologier og løsninger Perfekt udformet til dine behov

Freuds førsteklasses skæreværktøjer er fremstillet med unikke og innovative egenskaber. Virksomheden ejer og håndterer hele fremstillingsprocessen med en komplet og nøje kvalitetskontrol på tværs af alle sine fabrikker i Italien. Den kontinuerlige investering i forskning & udvikling kombineret med Freuds omfattende tekniske færdigheder og avancerede teknologier resulterer i produkter med innovative egenskaber, ekstrem præcision og forlænget holdbarhed. Altid den rette løsning til dine anvendelsesbehov.



Teknologisk overlegenhed In-house-karbidproduktion

Førende indenfor karbidfremstilling siden 1980: Freud tilbyder med stolthed en verdensunik in-house-produktion og sintring af karbidkomponenter til førsteklasses skæreværktøjer. Freud TiCo, som er en specialformuleret og yderst kompakt kombination af titanium og koboltkarbid, sikrer maksimal præcision og langvarig skærekantskarphe

Evnen til at formulere dedikerede opskrifter til standard og brugertilpassede anvendelser muliggør den højeste værktøjsydelse.

Global distribution Verdensomspændende serviceydelser uanset hvor du befinder dig

Freuds tro på at man bør "tænke globalt og handle lokalt" har medført, at virksomheden har dannet et omfattende netværk af udvalgte partnere og datterselskaber i mere en 90 lande. På denne måde kan virksomheden støtte sine kunder hvor som helst i verden.



freud

freud S.p.A.
Società Unipersonale
Via Remigio Solari, 7
33050 Pavia di Udine (UD) IT

www.freudtools.com



MKFRM 245 - F03FA24204 Printed in Italy - September 2023 - Rev. 0