

freud

Precisely
the best



GRANDE GAMME DE FRAISES DE QUALITÉ SUPÉRIEURE

| | | |
|----------------------|--|--|
| Fraises droites | | Fraises droites Freud dans tous les diamètres de queue usuels et avec des diamètres de coupe jusqu'à 25 mm. Conçues pour réaliser des coupes nettes et précises dans de multiples applications. |
| Fraises à affleurer | | Grande gamme de fraises à affleurer Freud pour réaliser des affleurages précis dans des plans de travail stratifiés ou en bois plaqué. Pour suivre des gabarits, pour créer ou reproduire des formes complexes ou pour effectuer des coupes nettes le long de bords affleurants. |
| Fraises à profiler | | Les fraises à profiler Freud pour toutes les applications de profilage, notamment pour réaliser des arrondis, des chanfreins et bien plus encore. |
| Fraises d'assemblage | | Les fraises d'assemblage Freud, incluant aussi bien des fraises circulaires à rainurer que des fraises à queue d'aronde, sont conçues pour réaliser des assemblages parfaits. |
| Fraises à surfacer | | Les fraises à surfacer Freud pour un rainurage de profil parfait sur des surfaces en bois. |
| Coffrets | | Les coffrets sont disponibles dans les diamètres de queue les plus courants et incluent notamment nos coffrets pour portes de meubles. |

Récapitulatif des icônes



Défonceuses
portatives



Défonceuses
sur table



Machines CNC



Bois tendres
et bois durs



Contreplaqué



Panneaux à base
de bois



Surfaces dures



ACM

Outils de fraisage pour défonceuses
électroportatives, à tables et numériques

CARACTÉRISTIQUES DES PRODUITS

RAISONS POUR LESQUELLES FREUD EST PRECISELY THE BEST



Longue durée de vie

Denture carbure extrêmement endurante.
Développement et production réalisés en interne.



Technologie Shear Angle

Angles de cisaillement optimisés pour obtenir
des performances et une finition remarquables.

Roulement à billes

Utilisation de roulement à billes de grande
qualité conçus pour les vitesses élevées.
Protection contre la poussière pour une
longévité très élevée.



Technologie de revêtement innovante

Le revêtement Perma-SHIELD
hautement performant protège la fraise
contre les frottements, la rouille,
l'agglomération de résine et la corrosion
pour une durée de vie prolongée.

Résistance extrême aux chocs

Processus de brasage perfectionné
conférant à la fraise une très grande flexibilité
et tenue aux chocs quel que soit le profilé.



Carbure TiCo

- Un carbure de titane cobalt (TiCo) spécialement formulé,
conçu et fabriqué par Freud.
- Permet d'obtenir des arêtes de coupe plus tranchantes
et des résultats parfaits avec une durée beaucoup plus longue.



Revêtement Perma-SHIELD

- Un revêtement anti-adhérent qui supporte les applications les plus
exigeantes.
- Il offre une bonne isolation thermique, protège contre la corrosion
et réduit l'adhérence des résines ou sèves, ce qui évite d'avoir à effectuer des
pauses pour nettoyer la fraise.



UNE SOLUTION SPÉCIALISÉE POUR LES ASSEMBLAGES



Pour défonceuses sur table



Pour les bois et dérivés



A tr/min max. Code Freud N° article

mm tr/min

12 16.000 99-03612P F03FR02432

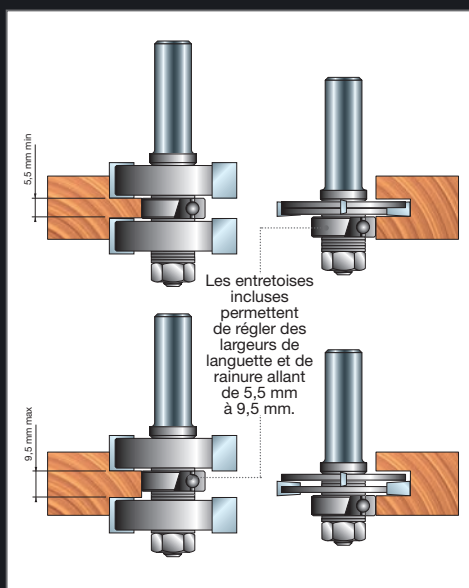

- Le set réglable à bouveter et rainurer est idéal pour les projets qui obligent à réaliser des assemblages à rainure et languette de grande précision avec une finition parfaite.
- Le set inclut une fraise à bouveter et une fraise à rainurer.



FRAISES DROITES

Fraises droites à deux tranchants 04- 12- MM- R006M

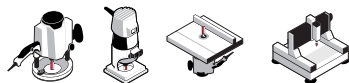

Type A - Fraises en carbure massif

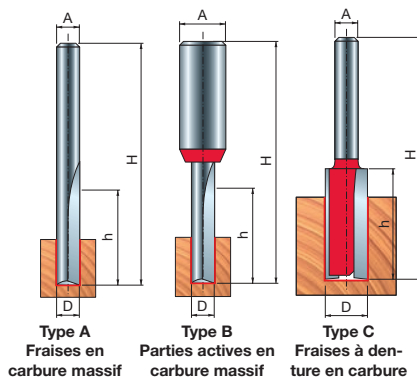

| D | h | H | A | Z | tr/min max. | Code Freud | N° article |
|----|------|------|----|------|-------------|-------------------|------------|
| mm | mm | mm | mm | inch | tr/min | | |
| 2 | 6,3 | 44,5 | 6 | 2 | 24.000 | 04-09706P | F03FR01413 |
| 3 | 9,5 | 44,5 | 6 | 2 | 24.000 | 04-09906P | F03FR01415 |
| 3 | 11 | 50,8 | 6 | 2 | 24.000 | 04-10006P | F03FR01418 |
| 3 | 12 | 50 | 6 | 2 | 24.000 | R006M03006 | F03FR01355 |
| 4 | 12 | 50,3 | 6 | 2 | 24.000 | R006M05006 | F03FR01356 |
| 4 | 12 | 50,8 | 6 | 2 | 24.000 | 04-10206P | F03FR01423 |
| 4 | 15,8 | 50,7 | 6 | 2 | 24.000 | 04-10106P | F03FR01420 |
| 5 | 12 | 50,3 | 6 | 2 | 24.000 | R006M07006 | F03FR01357 |
| 5 | 12,7 | 50,8 | 6 | 2 | 24.000 | 04-11306P | F03FR01437 |
| 5 | 16 | 51 | 6 | 2 | 24.000 | R006M07406 | F03FR01358 |

| D | h | H | A | | Z | tr/min max. | Code Freud | N° article |
|------|-------|------|----|------|---|-------------|------------|------------|
| mm | mm | mm | mm | inch | | tr/min | | |
| 6 | 16 | 50,8 | 6 | | 2 | 24.000 | 04-11406P | F03FR01440 |
| 6 | 16 | 57 | 6 | | 2 | 24.000 | R006M09406 | F03FR01359 |
| 6 | 25 | 63 | 6 | | 2 | 24.000 | R006M10206 | F03FR01360 |
| 6 | 25,4 | 76,2 | 6 | | 2 | 24.000 | 04-11006P | F03FR01431 |
| 3 | 9,5 | 44,5 | 8 | | 2 | 24.000 | 04-09908P | F03FR01416 |
| 4 | 15,8 | 50,7 | 8 | | 2 | 24.000 | 04-10108P | F03FR01421 |
| 5 | 12,7 | 50,8 | 8 | | 2 | 24.000 | 04-11308P | F03FR01438 |
| 6 | 16 | 50,8 | 8 | | 2 | 24.000 | 04-11408P | F03FR01441 |
| 6 | 25,4 | 76,2 | 8 | | 2 | 24.000 | 04-11008P | F03FR01432 |
| 1,58 | 6,4 | 44,5 | | 1/4 | 2 | 24.000 | 04-09625P | F03FR01412 |
| 2 | 4 | 38,1 | | 1/4 | 2 | 24.000 | 04-50225P | F03FR01502 |
| 2,38 | 9,5 | 38,1 | | 1/4 | 2 | 24.000 | 04-09825P | F03FR01414 |
| 3 | 8 | 44,5 | | 1/4 | 2 | 24.000 | 04-50825P | F03FR01503 |
| 3,18 | 9,5 | 44,5 | | 1/4 | 2 | 24.000 | 04-10025P | F03FR01419 |
| 4 | 15,77 | 50,8 | | 1/4 | 2 | 24.000 | 04-10125P | F03FR01422 |
| 4,76 | 12,7 | 49,2 | | 1/4 | 2 | 24.000 | 04-10225P | F03FR01424 |
| 5 | 11,9 | 50,8 | | 1/4 | 2 | 24.000 | 04-51225P | F03FR01504 |
| 6,35 | 12,7 | 50,5 | | 1/4 | 2 | 24.000 | 04-10425P | F03FR01426 |
| 6,35 | 15,9 | 50,8 | | 1/4 | 2 | 24.000 | 04-10525P | F03FR01427 |
| 6,35 | 19 | 57,1 | | 1/4 | 2 | 24.000 | 04-10625P | F03FR01428 |
| 6,35 | 22,2 | 57,1 | | 1/4 | 2 | 24.000 | 04-10725P | F03FR01429 |
| 6,35 | 25,4 | 63,5 | | 1/4 | 2 | 24.000 | 04-10825P | F03FR01430 |
| 6,35 | 25,4 | 76,2 | | 1/4 | 2 | 24.000 | 04-11025P | F03FR01433 |
| 6,35 | 19 | 61 | | 1/2 | 2 | 24.000 | 12-10050P | F03FR01521 |
| 6,35 | 23 | 73 | | 1/2 | 2 | 24.000 | 12-10250P | F03FR01522 |

Type B - Parties actives en carbure massif

| D | h | H | A | Z | tr/min max. | Code Freud | N° article |
|----|------|----|----|---|-------------|------------|------------|
| mm | mm | mm | mm | | tr/min | | |
| 3 | 8 | 58 | 12 | 2 | 24.000 | 12-09612P | F03FR01517 |
| 4 | 10 | 58 | 12 | 2 | 24.000 | 12-09712P | F03FR01518 |
| 5 | 12,7 | 57 | 12 | 2 | 24.000 | 12-09812P | F03FR01519 |
| 6 | 19 | 64 | 12 | 2 | 24.000 | 12-09912P | F03FR01520 |

Type C - Fraises à denture en carbure

| D | h | H | A | | Z | tr/min max. | Code Freud | N° article |
|----|------|------|----|------|---|-------------|------------|------------|
| mm | mm | mm | mm | inch | | tr/min | | |
| 7 | 25,4 | 63,5 | 6 | | 2 | 24.000 | 04-11206P | F03FR01434 |
| 8 | 19,1 | 52 | 6 | | 2 | 24.000 | 04-11506P | F03FR01443 |
| 8 | 31,8 | 70 | 6 | | 2 | 24.000 | 04-11906P | F03FR01447 |
| 9 | 25 | 63 | 6 | | 2 | 24.000 | 04-12406P | F03FR01450 |
| 10 | 25,4 | 62,4 | 6 | | 2 | 24.000 | MM-01006P | F03FR00330 |
| 10 | 31,8 | 69 | 6 | | 2 | 24.000 | MM-11006P | F03FR00333 |
| 11 | 25,4 | 62 | 6 | | 2 | 24.000 | 04-13306P | F03FR01458 |
| 12 | 19 | 55,5 | 6 | | 2 | 24.000 | 04-13506P | F03FR01460 |

| D | h | H | A | Z | tr/min max. | Code Freud | N° article | |
|------|------|------|----|------|-------------|------------|------------|------------|
| mm | mm | mm | mm | inch | tr/min | | | |
| 12 | 31,8 | 68 | 6 | | 2 | 24.000 | 04-13706P | F03FR01464 |
| 13 | 25,4 | 62,4 | 6 | | 2 | 24.000 | 04-14206P | F03FR01470 |
| 14 | 19 | 56 | 6 | | 2 | 24.000 | 04-14306P | F03FR01472 |
| 14 | 31,8 | 68,2 | 6 | | 2 | 24.000 | 04-14506P | F03FR01475 |
| 15 | 20 | 57,2 | 6 | | 2 | 24.000 | 04-14606P | F03FR01478 |
| 15 | 31,8 | 68,2 | 6 | | 2 | 24.000 | 04-14706P | F03FR01480 |
| 16 | 19 | 51 | 6 | | 2 | 24.000 | 04-14906P | F03FR01483 |
| 16 | 31,8 | 66 | 6 | | 2 | 24.000 | 04-15006P | F03FR01486 |
| 18 | 20 | 52 | 6 | | 2 | 24.000 | 04-15106P | F03FR01488 |
| 19 | 19 | 54 | 6 | | 2 | 24.000 | 04-14006P | F03FR01468 |
| 20 | 19 | 56 | 6 | | 2 | 24.000 | 04-15506P | F03FR01492 |
| 22 | 19 | 51 | 6 | | 2 | 24.000 | 04-15706P | F03FR01495 |
| 24 | 20 | 52 | 6 | | 2 | 24.000 | 04-15806P | F03FR01498 |
| 25 | 19 | 56 | 6 | | 2 | 24.000 | 04-15906P | F03FR01500 |
| 7 | 25,4 | 63,5 | 8 | | 2 | 24.000 | 04-11208P | F03FR01435 |
| 8 | 19 | 52 | 8 | | 2 | 24.000 | 04-11508P | F03FR01444 |
| 8 | 31,8 | 70 | 8 | | 2 | 24.000 | 04-11908P | F03FR01448 |
| 9 | 25 | 63 | 8 | | 2 | 24.000 | 04-12408P | F03FR01451 |
| 10 | 25,4 | 62,4 | 8 | | 2 | 24.000 | MM-01008P | F03FR00331 |
| 10 | 31,8 | 69 | 8 | | 2 | 24.000 | MM-11008P | F03FR00334 |
| 12 | 19 | 55,5 | 8 | | 2 | 24.000 | 04-13508P | F03FR01461 |
| 12 | 31,8 | 63,8 | 8 | | 2 | 24.000 | 04-13708P | F03FR01465 |
| 14 | 19 | 56 | 8 | | 2 | 24.000 | 04-14308P | F03FR01473 |
| 14 | 31,8 | 68,2 | 8 | | 2 | 24.000 | 04-14508P | F03FR01476 |
| 15 | 20 | 57,2 | 8 | | 2 | 24.000 | 04-14608P | F03FR01479 |
| 15 | 31,8 | 68,2 | 8 | | 2 | 24.000 | 04-14708P | F03FR01481 |
| 16 | 19 | 51 | 8 | | 2 | 24.000 | 04-14908P | F03FR01484 |
| 16 | 31,8 | 66 | 8 | | 2 | 24.000 | 04-15008P | F03FR01487 |
| 18 | 20 | 52 | 8 | | 2 | 24.000 | 04-15108P | F03FR01489 |
| 20 | 19 | 56 | 8 | | 2 | 24.000 | 04-15508P | F03FR01493 |
| 22 | 19 | 51 | 8 | | 2 | 24.000 | 04-15708P | F03FR01496 |
| 24 | 20 | 52 | 8 | | 2 | 24.000 | 04-15808P | F03FR01499 |
| 25 | 19 | 56 | 8 | | 2 | 24.000 | 04-15908P | F03FR01501 |
| 7 | 18 | 67 | 12 | | 2 | 24.000 | 12-10312P | F03FR01523 |
| 8 | 31,8 | 76 | 12 | | 2 | 24.000 | 12-10712P | F03FR01525 |
| 9 | 31,8 | 76 | 12 | | 2 | 24.000 | 12-11012P | F03FR01528 |
| 10 | 31,8 | 76 | 12 | | 2 | 24.000 | 12-11212P | F03FR01530 |
| 12 | 38,1 | 80 | 12 | | 2 | 24.000 | 12-12212P | F03FR01534 |
| 12 | 50,5 | 98 | 12 | | 2 | 24.000 | 12-12812P | F03FR01537 |
| 13 | 25,4 | 66,7 | 12 | | 2 | 24.000 | 12-11612P | F03FR01531 |
| 14 | 31,8 | 73 | 12 | | 2 | 24.000 | 12-13412P | F03FR01540 |
| 15 | 31,8 | 69,8 | 12 | | 2 | 24.000 | 12-13512P | F03FR01541 |
| 16 | 38,1 | 76,1 | 12 | | 2 | 24.000 | 12-14012P | F03FR01544 |
| 18 | 38,1 | 80 | 12 | | 2 | 24.000 | 12-14312P | F03FR01547 |
| 19 | 25,4 | 63,4 | 12 | | 2 | 24.000 | 12-15212P | F03FR01548 |
| 20 | 38,1 | 80 | 12 | | 2 | 24.000 | 12-15912P | F03FR01553 |
| 22 | 38,1 | 80 | 12 | | 2 | 24.000 | 12-16912P | F03FR01556 |
| 7,14 | 25,4 | 65,4 | | 1/4 | 2 | 24.000 | 04-11225P | F03FR01436 |
| 7,94 | 25,4 | 71,4 | | 1/4 | 2 | 24.000 | 04-11825P | F03FR01446 |
| 9,53 | 22,2 | 59,2 | | 1/4 | 2 | 24.000 | 04-12025P | F03FR01449 |

| D | h | H | A | | Z | tr/min max. | Code Freud | N° article |
|-------|------|-------|----|------|---|-------------|------------------|------------|
| mm | mm | mm | mm | inch | | tr/min | | |
| 9,53 | 25,4 | 62,4 | | 1/4 | 2 | 24.000 | 04-12425P | F03FR01452 |
| 9,53 | 31,8 | 68,7 | | 1/4 | 2 | 24.000 | 04-12625P | F03FR01453 |
| 10 | 25,4 | 62,4 | | 1/4 | 2 | 24.000 | MM-01025P | F03FR00332 |
| 10 | 31,8 | 63,8 | | 1/4 | 2 | 24.000 | 04-52025P | F03FR01505 |
| 11,11 | 25,4 | 62,4 | | 1/4 | 2 | 24.000 | 04-12925P | F03FR01454 |
| 12 | 31,8 | 63,8 | | 1/4 | 2 | 24.000 | 04-52825P | F03FR01506 |
| 12,7 | 19 | 55,5 | | 1/4 | 2 | 24.000 | 04-13025P | F03FR01455 |
| 12,7 | 22,2 | 59,2 | | 1/4 | 2 | 24.000 | 04-13125P | F03FR01456 |
| 12,7 | 25,4 | 62,4 | | 1/4 | 2 | 24.000 | 04-13225P | F03FR01457 |
| 12,7 | 31,8 | 69,9 | | 1/4 | 2 | 24.000 | 04-13325P | F03FR01459 |
| 15 | 31,8 | 66,7 | | 1/4 | 2 | 24.000 | 04-53625P | F03FR01507 |
| 15,88 | 19 | 51 | | 1/4 | 2 | 24.000 | 04-13625P | F03FR01463 |
| 15,88 | 31,8 | 69,9 | | 1/4 | 2 | 24.000 | 04-13725P | F03FR01466 |
| 16 | 31,8 | 66,7 | | 1/4 | 2 | 24.000 | 04-54425P | F03FR01508 |
| 17,46 | 19,1 | 56,1 | | 1/4 | 2 | 24.000 | 04-13825P | F03FR01467 |
| 18 | 19,1 | 51,1 | | 1/4 | 2 | 24.000 | 04-54825P | F03FR01509 |
| 19 | 19 | 57 | | 1/4 | 2 | 24.000 | 04-14025P | F03FR01469 |
| 20 | 19,1 | 51,1 | | 1/4 | 2 | 24.000 | 04-55225P | F03FR01510 |
| 22,23 | 19,1 | 56,1 | | 1/4 | 2 | 24.000 | 04-14825P | F03FR01482 |
| 25,4 | 19,1 | 56,1 | | 1/4 | 2 | 24.000 | 04-15225P | F03FR01491 |
| 7,94 | 25,4 | 78,9 | | 1/2 | 2 | 24.000 | 12-10650P | F03FR01524 |
| 9,53 | 25,4 | 73,6 | | 1/2 | 2 | 24.000 | 12-10850P | F03FR01526 |
| 9,53 | 31,8 | 82 | | 1/2 | 2 | 24.000 | 12-11050P | F03FR01529 |
| 10 | 31,8 | 75 | | 1/2 | 2 | 24.000 | 12-52050P | F03FR01558 |
| 12 | 31,8 | 75 | | 1/2 | 2 | 24.000 | 12-53050P | F03FR01559 |
| 12,7 | 25,4 | 66,7 | | 1/2 | 2 | 24.000 | 12-11650P | F03FR01532 |
| 12,7 | 31,8 | 77 | | 1/2 | 2 | 24.000 | 12-11850P | F03FR01533 |
| 12,7 | 38,1 | 80,4 | | 1/2 | 2 | 24.000 | 12-12250P | F03FR01535 |
| 12,7 | 38,1 | 108 | | 1/2 | 2 | 24.000 | 12-12450P | F03FR01536 |
| 12,7 | 50,5 | 98 | | 1/2 | 2 | 24.000 | 12-12850P | F03FR01538 |
| 12,7 | 63,2 | 110,7 | | 1/2 | 2 | 24.000 | 12-13050P | F03FR01539 |
| 15,88 | 25,4 | 62,4 | | 1/2 | 2 | 24.000 | 12-13650P | F03FR01542 |
| 15,88 | 31,8 | 71,8 | | 1/2 | 2 | 24.000 | 12-13850P | F03FR01543 |
| 15,88 | 38,1 | 76,1 | | 1/2 | 2 | 24.000 | 12-14050P | F03FR01545 |
| 15,88 | 50,8 | 103 | | 1/2 | 2 | 24.000 | 12-14250P | F03FR01546 |
| 16 | 31,8 | 69,8 | | 1/2 | 2 | 24.000 | 12-54450P | F03FR01560 |
| 19 | 25,4 | 63,4 | | 1/2 | 2 | 24.000 | 12-15250P | F03FR01549 |
| 19 | 31,8 | 69,8 | | 1/2 | 2 | 24.000 | 12-15450P | F03FR01550 |
| 19 | 38,1 | 76,1 | | 1/2 | 2 | 24.000 | 12-15650P | F03FR01551 |
| 19,05 | 50,8 | 88,8 | | 1/2 | 2 | 24.000 | 12-15850P | F03FR01552 |
| 20,63 | 31,8 | 76 | | 1/2 | 2 | 24.000 | 12-16250P | F03FR01554 |
| 22,23 | 31,8 | 76 | | 1/2 | 2 | 24.000 | 12-16850P | F03FR01555 |
| 25,4 | 31,8 | 69,8 | | 1/2 | 2 | 24.000 | 12-17250P | F03FR01557 |

Set cuisiniste 88-

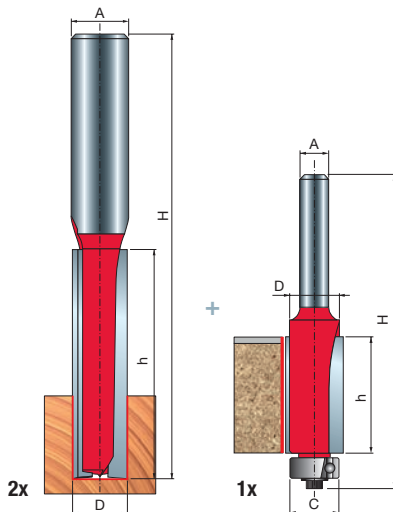
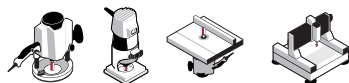

| | A | tr/min max. | Code Freud | N° article |
|---|------------|-------------|------------------|------------|
| | inch | tr/min | | |
| Set 2 fraises à rainurer droit et 1 fraise à affleurer | 1/2 1/4 | 24.000 | 88-20075P | F03FR04370 |

Fraises droites à deux tranchants avec pointe inférieure 17-

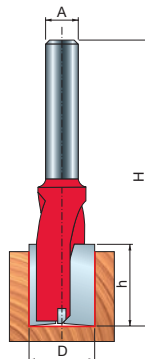
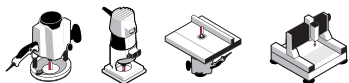

| D | h | H | A | Z | tr/min max. | Code Freud | N° article |
|----|----|-----|----|-----|-------------|------------------|------------|
| mm | mm | mm | mm | | tr/min | | |
| 16 | 45 | 85 | 8 | 2+1 | 24.000 | 17-10008P | F03FR01577 |
| 18 | 18 | 70 | 8 | 2+1 | 24.000 | 17-10208P | F03FR01578 |
| 20 | 18 | 70 | 8 | 2+1 | 24.000 | 17-10408P | F03FR01579 |
| 22 | 25 | 70 | 8 | 2+1 | 24.000 | 17-10608P | F03FR01580 |
| 16 | 60 | 110 | 12 | 2+1 | 24.000 | 17-10112P | F03FA13994 |

Fraises droites à dents décalées

14-

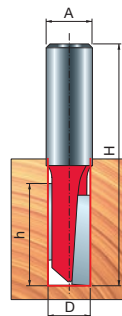
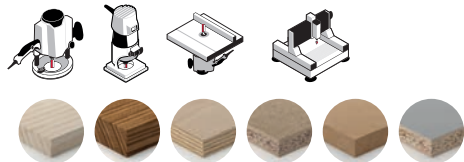

| D | h | H | A | Z | tr/min max. | Code Freud | N° article |
|------|------|------|----|---|-------------|------------------|------------|
| mm | mm | mm | mm | | tr/min | | |
| 9,53 | 37,8 | 82 | 12 | 2 | 24.000 | 14-10212P | F03FR01561 |
| 12,7 | 38,1 | 82 | 12 | 2 | 24.000 | 14-10412P | F03FR01562 |
| 12,7 | 37,8 | 79 | 12 | 2 | 24.000 | 14-20412P | F03FR01564 |
| 12,7 | 54 | 98,3 | 12 | 2 | 24.000 | 14-10612P | F03FR01563 |

Fraises à mortaiser

16-

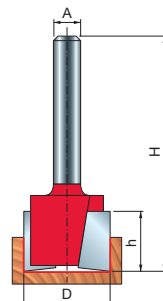
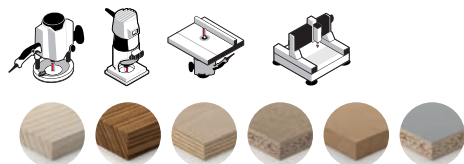

| D | h | H | A | Z | tr/min max. | Code Freud | N° article | |
|-------|------|-------|----|------|-------------|------------------|------------------|------------|
| mm | mm | mm | mm | inch | tr/min | | | |
| 12,7 | 12,5 | 51 | 6 | 2 | 24.000 | 16-10006P | F03FR01565 | |
| 19 | 12,5 | 51 | 6 | 2 | 24.000 | 16-10406P | F03FR01568 | |
| 19 | 19 | 62,15 | 6 | 2 | 24.000 | 16-50406P | F03FR01576 | |
| 12,7 | 12,5 | 50,8 | 8 | 2 | 24.000 | 16-10008P | F03FR01566 | |
| 19 | 12,5 | 50,8 | 8 | 2 | 24.000 | 16-10408P | F03FR01569 | |
| 12,7 | 12,5 | 60,5 | 12 | 2 | 24.000 | 16-11012P | F03FR01573 | |
| 31,75 | 12,1 | 56,2 | 12 | 2 | 24.000 | 16-11812P | F03FR01575 | |
| 12,7 | 12,5 | 51 | | 1/4 | 2 | 24.000 | 16-10025P | F03FR01567 |
| 19 | 12,5 | 51 | | 1/4 | 2 | 24.000 | 16-10425P | F03FR01570 |
| 12,7 | 12,5 | 60,5 | | 1/2 | 2 | 24.000 | 16-11050P | F03FR01574 |
| 31,75 | 12,7 | 56,2 | | 1/2 | 2 | 18.000 | 16-10850P | F03FR01572 |



FRAISES À AFFLEURER

Fraises à affleurer avec roulement supérieur 50-

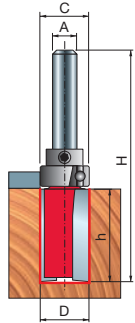
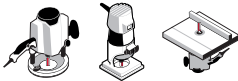

| D | h | H | A | C | Z | tr/min max. | Code Freud | N° article | |
|-------|------|------|----|------|-------|-------------|------------|------------------|------------|
| mm | mm | mm | mm | inch | mm | tr/min | | | |
| 13 | 20 | 60 | 6 | | 13 | 2 | 24.000 | 50-10206P | F03FR02003 |
| 15 | 20 | 60 | 6 | | 15 | 2 | 24.000 | 50-10406P | F03FR02006 |
| 19 | 25,4 | 67,5 | 6 | | 19 | 2 | 24.000 | 50-10606P | F03FR02008 |
| 16 | 20 | 60 | 8 | | 16 | 2 | 24.000 | 50-10308P | F03FR02005 |
| 22 | 20 | 60 | 8 | | 22 | 2 | 24.000 | 50-10808P | F03FR02010 |
| 12,7 | 25,4 | 65,4 | | 1/4 | 12,7 | 2 | 24.000 | 50-10225P | F03FR02004 |
| 15,88 | 25,4 | 65,4 | | 1/4 | 15,88 | 2 | 24.000 | 50-10425P | F03FR02007 |
| 19 | 25,4 | 68,5 | | 1/4 | 19 | 2 | 24.000 | 50-10625P | F03FR02009 |

Fraises à affleurer 42- 44-

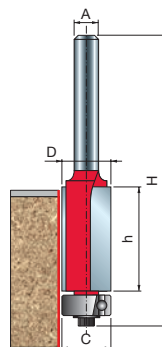

FRAISES À
AFFLEURER

| D | h | H | A | C | Z | tr/min max. | Code Freud | N° article | |
|------|------|-------|----|------|------|-------------|------------|------------|------------|
| mm | mm | mm | mm | inch | mm | tr/min | | | |
| 9,53 | 12,7 | 60,9 | 6 | | 9,53 | 2 | 24.000 | 42-10206P | F03FR01935 |
| 9,53 | 25,8 | 72,4 | 6 | | 9,53 | 2 | 24.000 | 42-10006P | F03FR01932 |
| 12,7 | 25,7 | 72,9 | 6 | | 12,7 | 2 | 24.000 | 42-10406P | F03FR01938 |
| 9,53 | 12,7 | 60,9 | 8 | | 9,53 | 2 | 24.000 | 42-10208P | F03FR01936 |
| 9,53 | 25,8 | 72,4 | 8 | | 9,53 | 2 | 24.000 | 42-10008P | F03FR01933 |
| 12,7 | 25,7 | 72,9 | 8 | | 12,7 | 2 | 24.000 | 42-10408P | F03FR01939 |
| 12,7 | 40 | 84 | 8 | | 12,7 | 2 | 24.000 | 42-11508P | F03FR02771 |
| 12,7 | 25,4 | 82,5 | 12 | | 12,7 | 2 | 24.000 | 42-11012P | F03FR01942 |
| 12,7 | 38,5 | 94,1 | 12 | | 12,7 | 2 | 24.000 | 42-11412P | F03FR01944 |
| 12,7 | 50,8 | 106,8 | 12 | | 12,7 | 2 | 24.000 | 42-11612P | F03FR01946 |
| 9,53 | 12,7 | 60,9 | | 1/4 | 9,53 | 2 | 24.000 | 42-10225P | F03FR01937 |
| 9,53 | 25,8 | 72,4 | | 1/4 | 9,53 | 2 | 24.000 | 42-10025P | F03FR01934 |
| 12,7 | 12,7 | 60,2 | | 1/4 | 12,7 | 2 | 24.000 | 42-10625P | F03FR01941 |
| 12,7 | 25,7 | 72,9 | | 1/4 | 12,7 | 2 | 24.000 | 42-10425P | F03FR01940 |
| 12,7 | 25,7 | 82,5 | | 1/2 | 12,7 | 2 | 24.000 | 42-11050P | F03FR01943 |
| 12,7 | 38,5 | 94,1 | | 1/2 | 12,7 | 2 | 24.000 | 42-11450P | F03FR01945 |
| 12,7 | 50,8 | 109,8 | | 1/2 | 12,7 | 2 | 24.000 | 42-11650P | F03FR01947 |
| 12,7 | 38,5 | 94,1 | | 1/2 | 12,7 | 3 | 24.000 | 44-10850P | F03FR01952 |

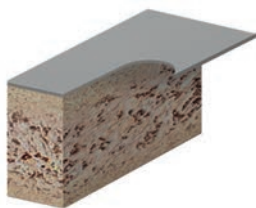

Fraises à affleurer avec rainure en « V » 48-

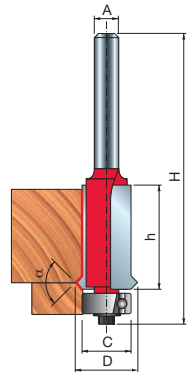

| D | h | H | A | C | α | Z | tr/min max. | Code Freud | N° article |
|-------|------|------|----|------|----------|---|-------------|------------------|------------|
| mm | mm | mm | mm | mm | | | tr/min | | |
| 15,88 | 25,4 | 76,2 | 6 | 12,7 | 90° | 2 | 20.000 | 48-10206P | F03FR02000 |
| 15,88 | 25,4 | 76,2 | 8 | 12,7 | 90° | 2 | 24.000 | 48-10208P | F03FR02001 |
| 15,88 | 25,4 | 87,2 | 12 | 12,7 | 90° | 2 | 24.000 | 48-11212P | F03FR02002 |

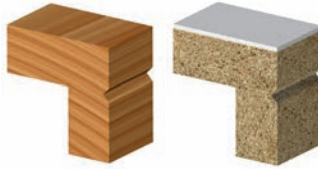

Fraises Oculus 26- 28-

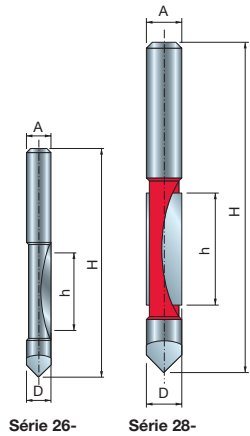
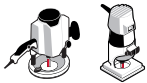

| D | h | H | A | Z | tr/min max. | Code Freud | N° article |
|--------|-------|------|----|------|-------------|------------------|------------|
| mm | mm | mm | mm | inch | tr/min | | |
| • 6 | 19 | 57 | 6 | 1 | 24.000 | 26-10006P | F03FR01664 |
| • 8 | 19 | 75 | 8 | 1 | 24.000 | 26-10008P | F03FR01665 |
| • 12,7 | 31,75 | 96,2 | 12 | 2 | 24.000 | 28-10412P | F03FR01692 |
| • 6,35 | 19 | 57 | | 1/4 | 24.000 | 26-10025P | F03FR01666 |
| • 12,7 | 31,75 | 96,2 | | 1/2 | 24.000 | 28-10450P | F03FR01693 |

- Fraises en carbure massif

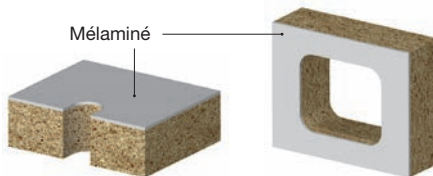



FRAISES À PROFILER

Fraises pour quart de rond 34- 36-

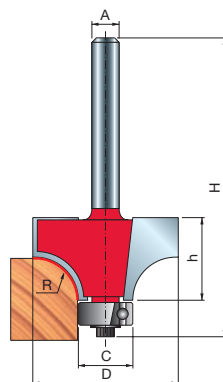

| D | h | H | A | C | R | Z | tr/min max. | Code Freud | N° article |
|-------|------|-------|----|------|------|----|-------------|------------------|------------|
| mm | mm | mm | mm | inch | mm | mm | tr/min | | |
| 15,88 | 12,7 | 54,9 | 6 | 12,7 | 1,59 | 2 | 24.000 | 34-10006P | F03FR01763 |
| 16,7 | 12,7 | 54,9 | 6 | 12,7 | 2 | 2 | 24.000 | 34-10106P | F03FR02766 |
| 19,05 | 12,7 | 55,2 | 6 | 12,7 | 3,18 | 2 | 24.000 | 34-10406P | F03FR01768 |
| 22,22 | 12,7 | 54,9 | 6 | 12,7 | 4,8 | 2 | 24.000 | 34-10806P | F03FR01771 |
| 25,4 | 12,7 | 54,7 | 6 | 9,53 | 6,35 | 2 | 24.000 | 36-11006P | F03FR01803 |
| 25,4 | 12,7 | 55,2 | 6 | 12,7 | 6,35 | 2 | 24.000 | 34-11006P | F03FR01774 |
| 28,58 | 12,7 | 55,2 | 6 | 12,7 | 8 | 2 | 18.000 | 34-11206P | F03FR01777 |
| 31,75 | 18 | 59,7 | 6 | 12,7 | 9,53 | 2 | 18.000 | 34-11406P | F03FR01780 |
| 31,75 | 18 | 59,2 | 6 | 9,53 | 9,53 | 2 | 18.000 | 36-11406P | F03FR01804 |
| 38,1 | 19,1 | 61,25 | 6 | 12,7 | 12,7 | 2 | 16.000 | 34-11606P | F03FR01783 |

| D | h | H | A | C | R | Z | tr/min max. | Code Freud | N° article | |
|-------|-------|-------|----|------|------|-------|-------------|------------|------------------|------------|
| mm | mm | mm | mm | inch | mm | mm | tr/min | | | |
| 15,88 | 12,7 | 54,9 | 8 | | 12,7 | 1,59 | 2 | 24.000 | 34-10008P | F03FR01764 |
| 16,7 | 12,7 | 54,9 | 8 | | 12,7 | 2 | 2 | 24.000 | 34-10108P | F03FR01766 |
| 18,7 | 12,7 | 54,9 | 8 | | 12,7 | 3 | 2 | 24.000 | 34-10308P | F03FR01767 |
| 19,05 | 12,7 | 55,2 | 8 | | 12,7 | 3,18 | 2 | 24.000 | 34-10408P | F03FR01769 |
| 22,22 | 13,2 | 54,9 | 8 | | 12,7 | 4,75 | 2 | 24.000 | 34-10808P | F03FR01772 |
| 25,4 | 12,7 | 55,2 | 8 | | 12,7 | 6,35 | 2 | 24.000 | 34-11008P | F03FR01775 |
| 28,58 | 12,7 | 55,2 | 8 | | 12,7 | 7,94 | 2 | 18.000 | 34-11208P | F03FR01778 |
| 31,75 | 18 | 59,7 | 8 | | 12,7 | 9,5 | 2 | 18.000 | 34-11408P | F03FR01781 |
| 38,1 | 19,1 | 61,25 | 8 | | 12,7 | 12,7 | 2 | 16.000 | 34-11608P | F03FR01784 |
| 44,44 | 22,2 | 64,72 | 8 | | 12,7 | 15,8 | 2 | 16.000 | 34-12708P | F03FR01793 |
| 25,4 | 12,7 | 61,2 | 12 | | 12,7 | 6,35 | 2 | 24.000 | 34-12012P | F03FR01786 |
| 31,75 | 18 | 65,7 | 12 | | 12,7 | 9,53 | 2 | 18.000 | 34-12412P | F03FR01788 |
| 38,1 | 19,05 | 67,25 | 12 | | 12,7 | 12,7 | 2 | 16.000 | 34-12612P | F03FR01791 |
| 44,44 | 22,22 | 70,72 | 12 | | 12,7 | 15,8 | 2 | 16.000 | 34-12712P | F03FR01794 |
| 50,8 | 25,4 | 73,9 | 12 | | 12,7 | 19 | 2 | 16.000 | 34-12812P | F03FR01796 |
| 57,15 | 31,4 | 79,85 | 12 | | 12,7 | 22,2 | 2 | 16.000 | 34-13012P | F03FR01798 |
| 63,5 | 31,3 | 79,75 | 12 | | 12,7 | 25,4 | 2 | 12.000 | 34-13212P | F03FR01799 |
| 69,85 | 34,9 | 83,3 | 12 | | 12,7 | 28,6 | 2 | 12.000 | 34-13412P | F03FR01801 |
| 76,2 | 38,1 | 86,6 | 12 | | 12,7 | 31,8 | 2 | 12.000 | 34-13612P | F03FR01802 |
| 15,88 | 12,7 | 54,9 | | 1/4 | 12,7 | 1,59 | 2 | 24.000 | 34-10025P | F03FR01765 |
| 19,05 | 12,7 | 55,2 | | 1/4 | 12,7 | 3,18 | 2 | 24.000 | 34-10425P | F03FR01770 |
| 22,22 | 13,2 | 54,9 | | 1/4 | 12,7 | 4,25 | 2 | 24.000 | 34-10825P | F03FR01773 |
| 25,4 | 12,7 | 55,2 | | 1/4 | 12,7 | 6,35 | 2 | 24.000 | 34-11025P | F03FR01776 |
| 28,58 | 12,7 | 55,2 | | 1/4 | 12,7 | 7,94 | 2 | 18.000 | 34-11225P | F03FR01779 |
| 31,75 | 18 | 59,7 | | 1/4 | 12,7 | 9,53 | 2 | 18.000 | 34-11425P | F03FR01782 |
| 38,1 | 19,1 | 61,25 | | 1/4 | 12,7 | 12,7 | 2 | 16.000 | 34-11625P | F03FR01785 |
| 25,4 | 12,7 | 61,2 | | 1/2 | 12,7 | 6,35 | 2 | 24.000 | 34-12050P | F03FR01787 |
| 31,75 | 18 | 65,7 | | 1/2 | 12,7 | 9,53 | 2 | 18.000 | 34-12450P | F03FR01790 |
| 38,1 | 19,1 | 67,25 | | 1/2 | 12,7 | 12,7 | 2 | 16.000 | 34-12650P | F03FR01792 |
| 44,44 | 22,2 | 70,7 | | 1/2 | 12,7 | 15,87 | 2 | 16.000 | 34-12750P | F03FR01795 |
| 50,8 | 25,4 | 73,9 | | 1/2 | 12,7 | 19,05 | 2 | 16.000 | 34-12850P | F03FR01797 |
| 63,5 | 31,25 | 79,8 | | 1/2 | 12,7 | 25,4 | 2 | 12.000 | 34-13250P | F03FR01800 |

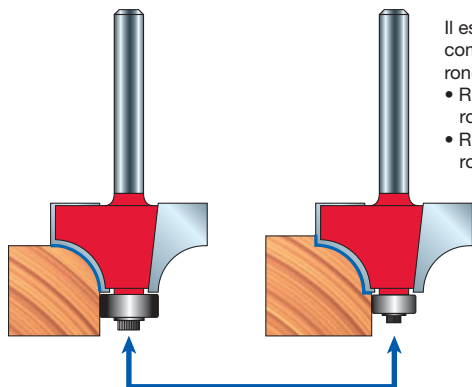

Il est possible d'obtenir un profil différent en commandant un petit roulement à billes et une rondelle étagée :

- Roulement à billes **3102M AA9** (Ø 9,53 mm) et rondelle étagée **FX07M AA9** pour la série 34-
- Roulement à billes **3102M AB9** (Ø 12,7 mm) et rondelle étagée **FX07M AB9** pour la série 36-

Fraises à chanfreiner 40-

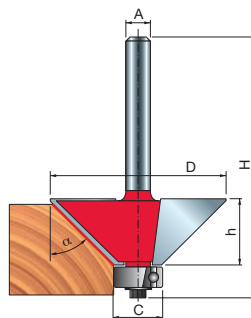
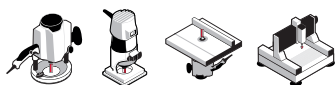

| D | h | H | A | C | α | Z | tr/min max. | Code Freud | N° article | |
|-------|------|-------|----|------|----------|-------|-------------|------------|------------------|------------|
| mm | mm | mm | mm | inch | mm | | tr/min | | | |
| 18,15 | 12,7 | 54,9 | 6 | | 12,7 | 15° | 2 | 24.000 | 40-10006P | F03FR01906 |
| 21,77 | 25 | 67,3 | 6 | | 12,7 | 11.3° | 2 | 24.000 | 40-09406P | F03FR01900 |
| 23,6 | 12,7 | 54,9 | 6 | | 12,7 | 25° | 2 | 24.000 | 40-10206P | F03FR01912 |
| 24 | 12 | 44 | 6 | | • | 30° | 2 | 24.000 | 40-90206P | F03FR01929 |
| 24 | 14 | 46 | 6 | | • | 15° | 2 | 24.000 | 40-90006P | F03FR01927 |
| 25 | 8 | 40,3 | 6 | | • | 45° | 2 | 24.000 | 40-90406P | F03FR01931 |
| 25,4 | 25,1 | 67,25 | 6 | | 12,7 | 15° | 2 | 24.000 | 40-09806P | F03FR01903 |
| 30,1 | 22,5 | 64,7 | 6 | | 12,7 | 22.5° | 2 | 18.000 | 40-10106P | F03FR01909 |
| 31 | 9,5 | 52,3 | 6 | | 12,7 | 45° | 2 | 18.000 | 40-10506P | F03FR01917 |
| 33 | 11,5 | 54 | 6 | | 12,7 | 45° | 2 | 16.000 | 40-10406P | F03FR01914 |
| 33 | 19 | 61,6 | 6 | | 12,7 | 30° | 2 | 16.000 | 40-20206P | F03FR01925 |
| 44 | 18,5 | 61 | 6 | | 12,7 | 45° | 2 | 16.000 | 40-10606P | F03FR01919 |
| 18,15 | 12,7 | 54,9 | 8 | | 12,7 | 15° | 2 | 24.000 | 40-10008P | F03FR01907 |
| 21,77 | 25 | 67,3 | 8 | | 12,7 | 11.3° | 2 | 24.000 | 40-09408P | F03FR01901 |
| 23,6 | 12,7 | 54,9 | 8 | | 12,7 | 25° | 2 | 24.000 | 40-10208P | F03FR01913 |
| 24 | 12 | 44 | 8 | | • | 30° | 2 | 24.000 | 40-90208P | F03FR01930 |
| 24 | 14 | 46 | 8 | | • | 15° | 2 | 24.000 | 40-90008P | F03FR01928 |
| 25 | 8 | 40,3 | 8 | | • | 45° | 2 | 24.000 | 40-90408P | F03FR03255 |
| 25,4 | 25,1 | 67,25 | 8 | | 12,7 | 15° | 2 | 24.000 | 40-09808P | F03FR01904 |
| 30,1 | 22,5 | 64,7 | 8 | | 12,7 | 22.5° | 2 | 18.000 | 40-10108P | F03FR01910 |
| 31 | 9,5 | 52,3 | 8 | | 12,7 | 45° | 2 | 18.000 | 40-10508P | F03FR01918 |
| 33 | 11,5 | 54 | 8 | | 12,7 | 45° | 2 | 16.000 | 40-10408P | F03FR01915 |
| 33 | 19 | 61,6 | 8 | | 12,7 | 30° | 2 | 16.000 | 40-20208P | F03FR01926 |
| 44 | 18,5 | 61 | 8 | | 12,7 | 45° | 2 | 16.000 | 40-10608P | F03FR01920 |
| 21,77 | 25 | 73,3 | 12 | | 12,7 | 11.3° | 2 | 24.000 | 40-09412P | F03FR01902 |
| 25,4 | 25,1 | 73,25 | 12 | | 12,7 | 15° | 2 | 24.000 | 40-09812P | F03FR01905 |
| 30,1 | 22,5 | 70,7 | 12 | | 12,7 | 22.5° | 2 | 18.000 | 40-10112P | F03FR01911 |
| 44 | 18,5 | 67 | 12 | | 12,7 | 45° | 2 | 16.000 | 40-11412P | F03FR01922 |
| 62,1 | 25,5 | 74 | 12 | | 12,7 | 45° | 2 | 12.000 | 40-11812P | F03FR01924 |
| 18,15 | 12,7 | 54,9 | | 1/4 | 12,7 | 15° | 2 | 24.000 | 40-10025P | F03FR01908 |
| 33 | 11,5 | 53,9 | | 1/4 | 12,7 | 45° | 2 | 24.000 | 40-10425P | F03FR01916 |
| 41,5 | 15,9 | 58,4 | | 1/4 | 12,7 | 45° | 2 | 16.000 | 40-10625P | F03FR01921 |
| 43 | 18,5 | 67 | | 1/2 | 12,7 | 45° | 2 | 16.000 | 40-11450P | F03FR01923 |

- Sans roulement à billes.

Fraises à congés 30-

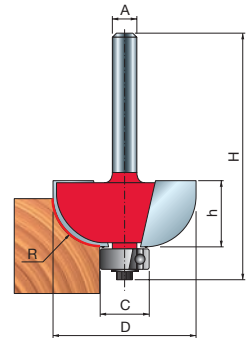
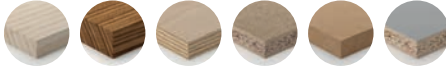

| D | h | H | A | C | R | Z | tr/min max. | Code Freud | N° article | |
|-------|------|------|----|------|------|------|-------------|------------|------------------|------------|
| mm | mm | mm | mm | inch | mm | mm | tr/min | | | |
| 19,05 | 14 | 56 | 6 | | 9,53 | 4,76 | 2 | 24.000 | 30-10006P | F03FR01694 |
| 22,23 | 13,2 | 54,7 | 6 | | 9,53 | 6,35 | 2 | 24.000 | 30-10206P | F03FR01697 |
| 25,4 | 12,7 | 54,7 | 6 | | 9,53 | 8 | 2 | 24.000 | 30-10306P | F03FR01700 |
| 31,75 | 12,7 | 55,2 | 6 | | 12,7 | 9,53 | 2 | 18.000 | 30-10406P | F03FR01703 |
| 38,1 | 16,4 | 58,9 | 6 | | 12,7 | 12,7 | 2 | 16.000 | 30-10606P | F03FR01706 |
| 19,05 | 14 | 56 | 8 | | 9,53 | 4,75 | 2 | 24.000 | 30-10008P | F03FR01695 |
| 22,23 | 13,2 | 54,7 | 8 | | 9,53 | 6,35 | 2 | 24.000 | 30-10208P | F03FR01698 |
| 25,4 | 12,7 | 54,7 | 8 | | 9,53 | 8 | 2 | 24.000 | 30-10308P | F03FR01701 |
| 31,75 | 12,7 | 55,2 | 8 | | 12,7 | 9,53 | 2 | 18.000 | 30-10408P | F03FR01704 |
| 38,1 | 16,4 | 58,9 | 8 | | 12,7 | 12,7 | 2 | 16.000 | 30-10608P | F03FR01707 |
| 19,05 | 14 | 62,4 | 12 | | 9,53 | 4,75 | 2 | 24.000 | 30-10012P | F03FR01696 |
| 22,23 | 12,7 | 60,7 | 12 | | 9,53 | 6,35 | 2 | 24.000 | 30-11012P | F03FR01709 |
| 25,4 | 12,7 | 60,7 | 12 | | 9,53 | 8 | 2 | 24.000 | 30-11112P | F03FR01710 |
| 31,75 | 12,7 | 61,2 | 12 | | 12,7 | 9,5 | 2 | 18.000 | 30-11212P | F03FR01711 |
| 38,1 | 16,4 | 64,9 | 12 | | 12,7 | 12,7 | 2 | 16.000 | 30-11412P | F03FR01713 |
| 22,23 | 13,2 | 54,7 | | 1/4 | 9,53 | 6,35 | 2 | 24.000 | 30-10225P | F03FR01699 |
| 25,4 | 12,7 | 54,7 | | 1/4 | 9,53 | 7,94 | 2 | 24.000 | 30-10325P | F03FR01702 |
| 31,75 | 12,7 | 55,2 | | 1/4 | 12,7 | 9,5 | 2 | 18.000 | 30-10425P | F03FR01705 |
| 38,1 | 16,4 | 58,9 | | 1/4 | 12,7 | 12,7 | 2 | 16.000 | 30-10625P | F03FR01708 |
| 31,75 | 12,7 | 61,2 | | 1/2 | 12,7 | 9,53 | 2 | 18.000 | 30-11250P | F03FR01712 |
| 38,1 | 16,4 | 64,9 | | 1/2 | 12,7 | 12,7 | 2 | 16.000 | 30-11450P | F03FR01714 |

Fraises à congés classiques 30-

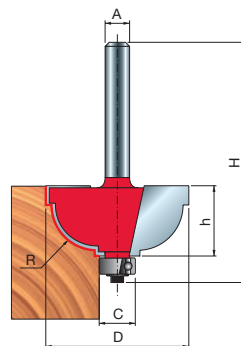
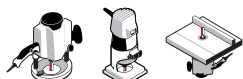

| D | h | H | A | C | R | Z | tr/min max. | Code Freud | N° article |
|-------|------|------|----|------|-----|---|-------------|------------------|------------|
| mm | mm | mm | mm | mm | mm | | tr/min | | |
| 28,58 | 13 | 54,2 | 6 | 9,53 | 4,8 | 2 | 18.000 | 30-30406P | F03FR01719 |
| 31,75 | 15,1 | 56,8 | 6 | 9,53 | 4,8 | 2 | 18.000 | 30-20206P | F03FR01715 |
| 28,58 | 13 | 54,2 | 8 | 9,53 | 4,8 | 2 | 18.000 | 30-30408P | F03FR01720 |
| 31,75 | 15,1 | 56,8 | 8 | 9,53 | 8 | 2 | 18.000 | 30-20208P | F03FR01716 |
| 28,58 | 13 | 60,2 | 12 | 9,53 | 4,8 | 2 | 18.000 | 30-32412P | F03FR01722 |
| 31,75 | 15,1 | 62,8 | 12 | 9,53 | 8 | 2 | 18.000 | 30-22212P | F03FR01718 |

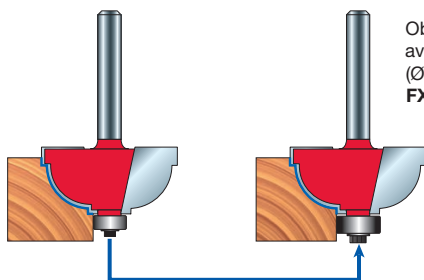

Obtention possible d'un profil différent avec le roulement à billes **3102M AB9** (Ø 12,7 mm) et la rondelle étagée **FX07M AB9** (à commander séparément).

Fraises à doucine avec feuillure

38- 99-

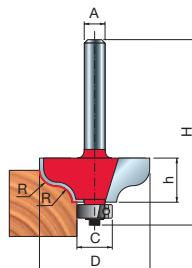

| D | h | H | A | C | R | Z | tr/min max. | Code Freud | N° article | |
|-------|------|------|----|------|------|------|-------------|------------|------------------|------------|
| mm | mm | mm | mm | inch | mm | mm | tr/min | | | |
| 31,75 | 12,2 | 53,9 | 6 | | 9,53 | 4,8 | 2 | 18.000 | 38-20206P | F03FR01815 |
| 38,1 | 16,2 | 57,4 | 6 | | 9,53 | 6,35 | 2 | 16.000 | 38-20406P | F03FR01818 |
| 31,75 | 12,2 | 53,9 | 8 | | 9,53 | 4,8 | 2 | 18.000 | 38-20208P | F03FR01816 |
| 38,1 | 16,2 | 57,4 | 8 | | 9,53 | 6,35 | 2 | 16.000 | 38-20408P | F03FR01819 |
| 31,75 | 12,2 | 59,9 | 12 | | 9,53 | 4,8 | 2 | 18.000 | 38-21212P | F03FR01821 |
| 38,1 | 16,2 | 63,4 | 12 | | 9,53 | 6,35 | 2 | 16.000 | 38-21412P | F03FR01822 |
| 31,75 | 12,2 | 53,9 | | 1/4 | 9,53 | 4,76 | 2 | 18.000 | 38-20225P | F03FR01817 |
| 31,75 | 12,2 | 54,4 | | 1/4 | 12,7 | 4,76 | 2 | 18.000 | 38-15225P | F03FR01814 |
| 38,1 | 16,2 | 57,4 | | 1/4 | 9,53 | 6,35 | 2 | 16.000 | 38-20425P | F03FR01820 |
| 38,1 | 16,5 | 64,7 | | 1/2 | 12,7 | 8,25 | 2 | 16.000 | 99-00650P | F03FR02412 |

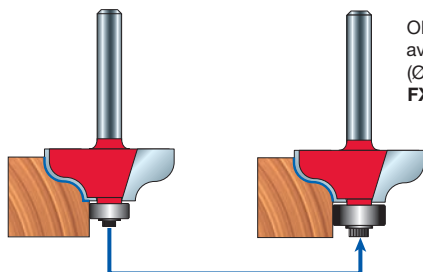

Obtention possible d'un profil différent avec le roulement à billes **3102M AB9** (Ø 12,7 mm) et la rondelle étagée **FX07M AB9** (à commander séparément).

Fraises à doucine romaine

38-

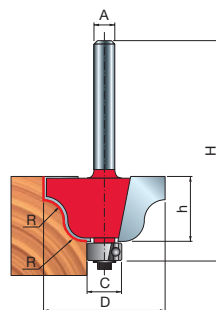

| D | h | H | A | C | R | Z | tr/min max. | Code Freud | N° article |
|----|------|-------|-----|------|------|----|-------------|------------------|------------|
| mm | mm | mm | mm | inch | mm | mm | tr/min | | |
| 27 | 13,3 | 55,3 | 6 | 9,53 | 4 | 2 | 18.000 | 38-1006P | F03FR01805 |
| 35 | 18,5 | 60,5 | 6 | 9,53 | 6,35 | 2 | 16.000 | 38-10206P | F03FR01808 |
| 27 | 13,3 | 55,3 | 8 | 9,53 | 4 | 2 | 18.000 | 38-10008P | F03FR01806 |
| 35 | 18,5 | 60,5 | 8 | 9,53 | 6,35 | 2 | 16.000 | 38-10208P | F03FR01809 |
| 27 | 13,3 | 61,31 | 12 | 9,53 | 4 | 2 | 18.000 | 38-10412P | F03FR01811 |
| 35 | 18,5 | 66,5 | 12 | 9,53 | 6,35 | 2 | 16.000 | 38-10612P | F03FR01812 |
| 27 | 13,3 | 55,3 | 1/4 | 9,53 | 4 | 2 | 18.000 | 38-10025P | F03FR01807 |
| 35 | 18,5 | 66,5 | 1/4 | 9,53 | 6,35 | 2 | 16.000 | 38-10225P | F03FR01810 |
| 35 | 18,5 | 66,5 | 1/2 | 9,53 | 6,35 | 2 | 16.000 | 38-10650P | F03FR01813 |

Fraises à doucine romaine classique

38- 99-

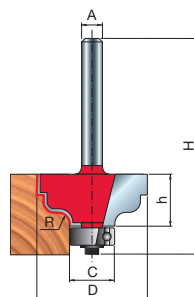

| D | h | H | A | C | R | Z | tr/min max. | Code Freud | N° article |
|-------|------|------|-----|------|------|----|-------------|------------------|------------|
| mm | mm | mm | mm | inch | mm | mm | tr/min | | |
| 31,75 | 15 | 56,7 | 6 | 12,7 | 3,18 | 2 | 18.000 | 38-40206P | F03FR01832 |
| 31,75 | 15 | 56,7 | 8 | 12,7 | 3,18 | 2 | 18.000 | 38-40208P | F03FR01833 |
| 34,92 | 14,3 | 62,8 | 12 | 12,7 | 4,8 | 2 | 16.000 | 99-00512P | F03FR02411 |
| 31,75 | 15 | 56,7 | 1/4 | 12,7 | 3,18 | 2 | 18.000 | 38-40225P | F03FR01834 |

Fraises à doucine classique

38- 99-

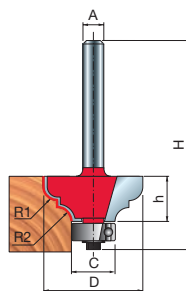

| D | h | H | A | C | R1 | R2 | Z | tr/min max. | Code Freud | N° article |
|-------|------|------|-----|------|------|------|----|-------------|------------------|------------|
| mm | mm | mm | mm | inch | mm | mm | mm | tr/min | | |
| 28,58 | 12,7 | 54,9 | 6 | 12,7 | 4 | 4 | 2 | 18.000 | 38-60206P | F03FR01838 |
| 34,92 | 18,3 | 60 | 6 | 12,7 | 6,35 | 4,76 | 2 | 16.000 | 38-60406P | F03FR01841 |
| 28,58 | 12,7 | 54,9 | 8 | 12,7 | 4 | 4 | 2 | 18.000 | 38-60208P | F03FR01839 |
| 34,92 | 18,3 | 60 | 8 | 12,7 | 6,35 | 4,76 | 2 | 16.000 | 38-60408P | F03FR01842 |
| 28,58 | 12,7 | 61,2 | 12 | 12,7 | 4 | 4 | 2 | 18.000 | 38-61212P | F03FR01843 |
| 34,92 | 17,5 | 65,7 | 12 | 12,7 | 6,35 | 4,76 | 2 | 16.000 | 38-61412P | F03FR01844 |
| 28,58 | 12,7 | 54,9 | 1/4 | 12,7 | 3,97 | 3,97 | 2 | 18.000 | 38-60225P | F03FR01840 |
| 34,93 | 14,7 | 62,4 | 1/2 | 9,53 | 5,35 | 5,35 | 2 | 16.000 | 99-00950P | F03FR02415 |
| 34,92 | 17,5 | 65,7 | 1/2 | 12,7 | 6,35 | 4,76 | 2 | 16.000 | 38-61450P | F03FR01845 |

Fraises classiques pour bordure de table

99-

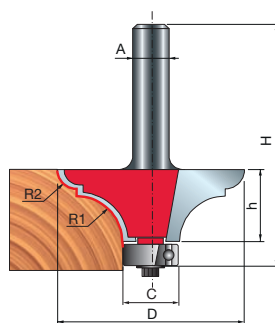

| D | h | H | A | C | R1 | R2 | Z | tr/min max. | Code Freud | N° article |
|------|------|------|----|------|----|-----|----|-------------|------------------|------------|
| mm | mm | mm | mm | mm | mm | mm | mm | tr/min | | |
| 41,3 | 15,9 | 58,4 | 8 | 12,7 | 10 | 4,3 | 2 | 16.000 | 99-01108P | F03FR02416 |
| 41,3 | 15,9 | 64,4 | 12 | 12,7 | 10 | 4,3 | 2 | 16.000 | 99-01112P | F03FR02417 |

Fraises pour double arrondi convexe 38-

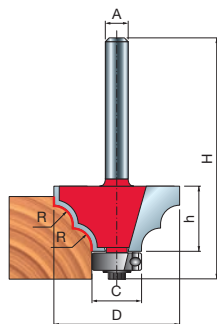

| D | h | H | A | C | R | Z | tr/min max. | Code Freud | N° article |
|------|----|------|----|------|----|---|-------------|------------------|------------|
| mm | mm | mm | mm | mm | mm | | tr/min | | |
| 32,7 | 15 | 57,2 | 6 | 12,7 | 5 | 2 | 16.000 | 38-90006P | F03FR01852 |
| 32,7 | 15 | 57,2 | 8 | 12,7 | 5 | 2 | 16.000 | 38-90008P | F03FR01853 |

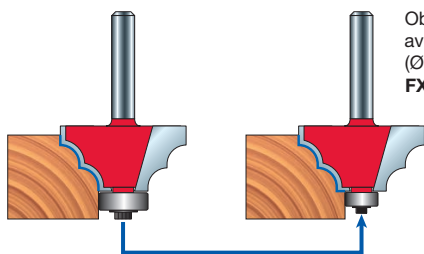

Obtention possible d'un profil différent avec le roulement à billes **3102M AA9** (Ø 9,53 mm) et la rondelle étagée **FX07M AA9** (à commander séparément).

Fraises pour double arrondi concave 38-

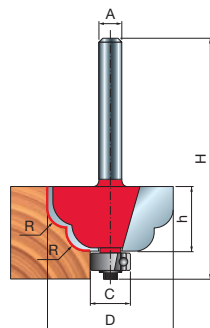

| D | h | H | A | C | R | Z | tr/min max. | Code Freud | N° article |
|------|----|------|----|------|----|---|-------------|------------------|------------|
| mm | mm | mm | mm | mm | mm | | tr/min | | |
| 32,7 | 15 | 57,2 | 6 | 12,7 | 5 | 2 | 16.000 | 38-95006P | F03FR01854 |
| 32,7 | 15 | 57,2 | 8 | 12,7 | 5 | 2 | 16.000 | 38-95008P | F03FR01855 |

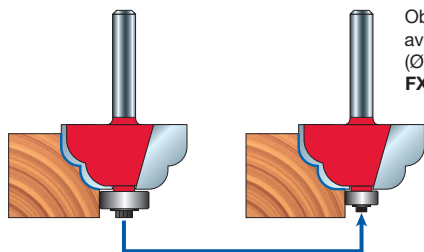

Obtention possible d'un profil différent avec le roulement à billes **3102M AA9** (Ø 9.53 mm) et la rondelle étagée **FX07M AA9** (à commander séparément).

Fraises pour arrondi concave / convexe 38-

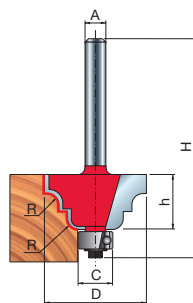

| D | h | H | A | C | R | Z | tr/min max. | Code Freud | N° article |
|-------|------|------|-----|------|------|----|-------------|------------------|------------|
| mm | mm | mm | mm | inch | mm | mm | tr/min | | |
| 29,38 | 13,5 | 55,5 | 6 | 9,53 | 3,97 | 2 | 18.000 | 38-30606P | F03FR01826 |
| 38,9 | 18,3 | 60 | 6 | 9,53 | 6,35 | 2 | 16.000 | 38-30406P | F03FR01823 |
| 29,38 | 13,5 | 55,5 | 8 | 9,53 | 3,97 | 2 | 18.000 | 38-30608P | F03FR01827 |
| 38,9 | 18,3 | 60 | 8 | 9,53 | 6,35 | 2 | 16.000 | 38-30408P | F03FR01824 |
| 29,38 | 13,5 | 61,2 | 12 | 9,53 | 3,97 | 2 | 18.000 | 38-31212P | F03FR01829 |
| 38,92 | 18,3 | 66 | 12 | 9,53 | 6,35 | 2 | 16.000 | 38-31412P | F03FR01831 |
| 38,9 | 18,3 | 60,8 | 1/4 | 9,53 | 6,35 | 2 | 16.000 | 38-30425P | F03FR01825 |

Fraises pour arrondi concave / convexe avec feuillure 38-

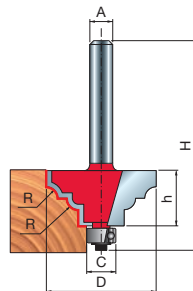

| D | h | H | A | C | R | Z | tr/min max. | Code Freud | N° article |
|------|------|------|----|------|----|---|-------------|------------------|------------|
| mm | mm | mm | mm | mm | mm | | tr/min | | |
| 32,7 | 14,5 | 56,7 | 6 | 12,7 | 3 | 2 | 16.000 | 38-80006P | F03FR01846 |
| 36,7 | 16,5 | 58,7 | 6 | 12,7 | 4 | 2 | 16.000 | 38-80206P | F03FR01848 |
| 40,7 | 18 | 60,2 | 6 | 12,7 | 5 | 2 | 16.000 | 38-80406P | F03FR01850 |
| 32,7 | 14,5 | 56,7 | 8 | 12,7 | 3 | 2 | 16.000 | 38-80008P | F03FR01847 |
| 36,7 | 16,5 | 58,7 | 8 | 12,7 | 4 | 2 | 16.000 | 38-80208P | F03FR01849 |
| 40,7 | 18 | 60,2 | 8 | 12,7 | 5 | 2 | 16.000 | 38-80408P | F03FR01851 |

Fraises à doucine à double feuillure 38-

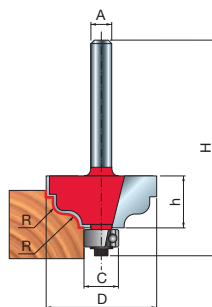

| D | h | H | A | C | R | Z | tr/min max. | Code Freud | N° article | |
|-------|----|------|----|------|------|------|-------------|------------|------------------|------------|
| mm | mm | mm | mm | inch | mm | mm | tr/min | | | |
| 31,75 | 15 | 56,2 | 6 | | 9,53 | 3,18 | 2 | 18.000 | 38-45206P | F03FR01835 |
| 31,75 | 15 | 56,2 | 8 | | 9,53 | 3,18 | 2 | 18.000 | 38-45208P | F03FR01836 |
| 31,75 | 15 | 56,2 | | 1/4 | 9,53 | 3,18 | 2 | 18.000 | 38-45225P | F03FR01837 |

Fraises pour cordon traditionnel 80-

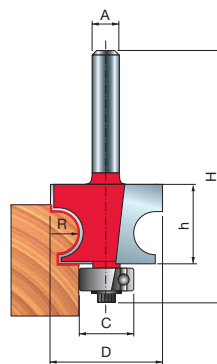

| D | h | H | A | C | R | Z | tr/min max. | Code Freud | N° article |
|-------|------|------|----|------|------|----|-------------|------------------|------------|
| mm | mm | mm | mm | mm | mm | mm | tr/min | | |
| 22,23 | 14,3 | 56,9 | 6 | 12,7 | 3,18 | 2 | 24.000 | 80-10206P | F03FR02192 |
| 25,4 | 17,5 | 60 | 6 | 12,7 | 4,76 | 2 | 24.000 | 80-10406P | F03FR02195 |
| 30,17 | 22,2 | 64,2 | 6 | 12,7 | 7,14 | 2 | 18.000 | 80-10806P | F03FR02198 |
| 22,23 | 14,3 | 57,1 | 8 | 12,7 | 3,18 | 2 | 24.000 | 80-10208P | F03FR02193 |
| 25,4 | 17,5 | 60 | 8 | 12,7 | 4,76 | 2 | 24.000 | 80-10408P | F03FR02196 |
| 30,17 | 22,2 | 64,2 | 8 | 12,7 | 7,14 | 2 | 18.000 | 80-10808P | F03FR02199 |
| 22,23 | 14,3 | 62,9 | 12 | 12,7 | 3,18 | 2 | 24.000 | 80-12212P | F03FR02201 |
| 25,4 | 17,5 | 66,4 | 12 | 12,7 | 4,76 | 2 | 24.000 | 80-12412P | F03FR02203 |
| 30,17 | 22,2 | 70,6 | 12 | 12,7 | 7,14 | 2 | 18.000 | 80-12812P | F03FR02204 |

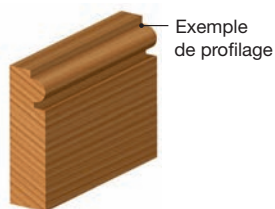

Fraises pour triple arrondi 80-

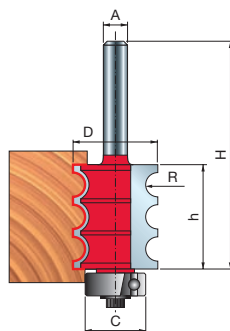

| D | h | H | A | C | R | Z | tr/min max. | Code Freud | N° article |
|-------|------|------|----|-------|------|---|-------------|------------------|------------|
| mm | mm | mm | mm | mm | mm | | tr/min | | |
| 22,24 | 27,4 | 70,9 | 6 | 15,88 | 3,18 | 2 | 18.000 | 80-55206P | F03FR02205 |
| 22,24 | 27,4 | 70,9 | 8 | 15,88 | 3,18 | 2 | 24.000 | 80-55208P | F03FR02206 |
| 22,24 | 27,4 | 76,9 | 12 | 15,88 | 3,18 | 2 | 24.000 | 80-57212P | F03FR02207 |

Fraises à trois tranchants 84-

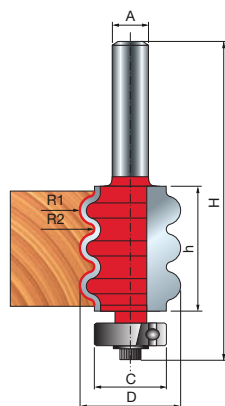

| D | h | H | A | C | R1 | R2 | Z | tr/min max. | Code Freud | N° article |
|-------|------|------|----|-------|------|------|---|-------------|------------------|------------|
| mm | mm | mm | mm | mm | mm | mm | | tr/min | | |
| 22,24 | 27,4 | 70,9 | 6 | 15,88 | 3,18 | 1,16 | 2 | 24.000 | 84-10606P | F03FR02220 |
| 22,24 | 27,4 | 70,9 | 8 | 15,88 | 3,18 | 1,16 | 2 | 24.000 | 84-10608P | F03FR02221 |
| 22,24 | 27,4 | 76,9 | 12 | 15,88 | 3,18 | 1,16 | 2 | 24.000 | 84-12612P | F03FR02222 |

Fraises à doucine avec roulement supérieur pour profils concaves

23-



Type A

| D | h | H | A | C | R | Z | tr/min max. | Code Freud | N° article |
|------|------|------|----|----|------|---|-------------|------------------|------------|
| mm | mm | mm | mm | mm | mm | | tr/min | | |
| 39,5 | 11,5 | 54,6 | 8 | 19 | 4 | 2 | 16.000 | 23-10008P | F03FR01654 |
| 39,5 | 11,5 | 58 | 12 | 19 | 4 | 2 | 16.000 | 23-10012P | F03FR01655 |
| 54 | 11,5 | 58 | 12 | 19 | 4 | 2 | 16.000 | 23-10212P | F03FR01656 |
| 60,5 | 17,3 | 63,8 | 12 | 19 | 6,35 | 2 | 12.000 | 23-10412P | F03FR01657 |

Type B

| D | h | H | A | C | R | Z | tr/min max. | Code Freud | N° article |
|----|------|------|----|----|------|---|-------------|------------------|------------|
| mm | mm | mm | mm | mm | mm | | tr/min | | |
| 38 | 12,5 | 55,6 | 8 | 19 | 6,35 | 2 | 16.000 | 23-20008P | F03FR01658 |
| 38 | 12,5 | 59 | 12 | 19 | 6,35 | 2 | 16.000 | 23-20012P | F03FR01659 |

Type C

| D | h | H | A | C | R | Z | tr/min max. | Code Freud | N° article |
|----|------|------|----|----|------|---|-------------|------------------|------------|
| mm | mm | mm | mm | mm | mm | | tr/min | | |
| 35 | 13,2 | 56,3 | 8 | 19 | 8 | 2 | 16.000 | 23-20208P | F03FR01660 |
| 38 | 14,5 | 57,6 | 8 | 19 | 9,53 | 2 | 16.000 | 23-20408P | F03FR01662 |
| 35 | 13,2 | 59,7 | 12 | 19 | 8 | 2 | 16.000 | 23-20212P | F03FR01661 |
| 38 | 14,5 | 61 | 12 | 19 | 9,53 | 2 | 16.000 | 23-20412P | F03FR01663 |

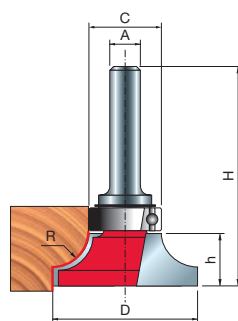
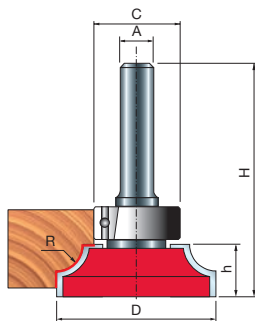
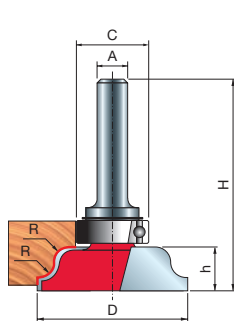

Fraises pour bordure de table et main courante

99-



Type A

| D | h | H | A | C | R1 | R2 | α | Z | tr/min max. | Code Freud | N° article |
|------|----|------|----|------|----|----|----------|---|-------------|------------------|------------|
| mm | mm | mm | mm | mm | mm | mm | | | tr/min | | |
| 63,5 | 18 | 66,2 | 12 | 12,7 | 30 | 8 | 15° | 2 | 12.000 | 99-02712P | F03FR02421 |

Type B

| D | h | H | A | C | R | α | Z | tr/min max. | Code Freud | N° article |
|----|------|------|----|------|------|----------|---|-------------|------------------|------------|
| mm | mm | mm | mm | mm | mm | | | tr/min | | |
| 35 | 38,5 | 86,6 | 12 | 12,7 | 3,18 | 25° | 2 | 16.000 | 99-07212P | F03FR02456 |

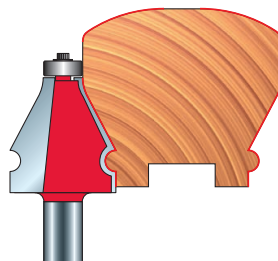
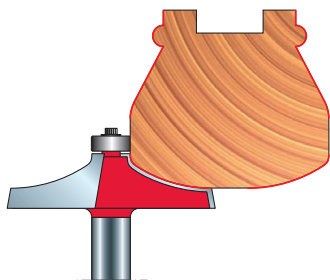
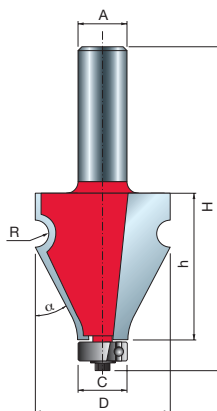
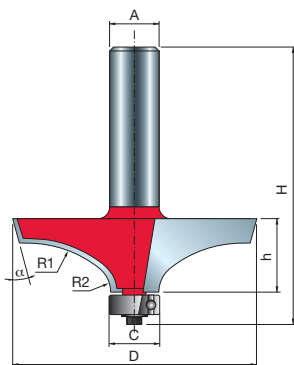

Fraises pour demi-rond 82-

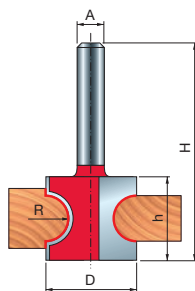
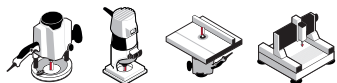

| D | h | H | A | R | Z | tr/min max. | Code Freud | N° article |
|-------|-------|-------|-----|------|----|-------------|------------------|------------|
| mm | mm | mm | mm | inch | mm | tr/min | | |
| 19 | 12,4 | 44,4 | 6 | 3,18 | 2 | 24.000 | 82-10206P | F03FR02208 |
| 22,22 | 19,5 | 51,5 | 6 | 4,8 | 2 | 24.000 | 82-10406P | F03FR02210 |
| 25,4 | 22,9 | 54,9 | 6 | 6,35 | 2 | 24.000 | 82-10606P | F03FR02213 |
| 19 | 12,4 | 44,4 | 8 | 3,18 | 2 | 24.000 | 82-10208P | F03FR02209 |
| 22,22 | 19,5 | 51,5 | 8 | 4,76 | 2 | 24.000 | 82-10408P | F03FR02211 |
| 25,4 | 22,9 | 54,9 | 8 | 6,35 | 2 | 24.000 | 82-10608P | F03FR02214 |
| 19 | 12,4 | 53,4 | 12 | 3,2 | 2 | 24.000 | 82-11012P | F03FR02215 |
| 22,22 | 19,5 | 60,5 | 12 | 4,76 | 2 | 24.000 | 82-11212P | F03FR02216 |
| 25,4 | 22,9 | 64,9 | 12 | 6,35 | 2 | 24.000 | 82-11412P | F03FR02217 |
| 37 | 29,05 | 71,05 | 12 | 9,5 | 2 | 16.000 | 82-11612P | F03FR02218 |
| 45,9 | 35,4 | 73,4 | 12 | 12,7 | 2 | 16.000 | 82-11812P | F03FR02219 |
| 22 | 19,5 | 51,5 | 1/4 | 4,76 | 2 | 24.000 | 82-10425P | F03FR02212 |

Fraises multiprofiles

99-



| D | h | H | A | C | R1 | R2 | R2 | Z | tr/min max. | Code Freud | N° article |
|-------|------|------|----|------|-----|------|-----|---|-------------|------------------|------------|
| mm | mm | mm | mm | mm | mm | mm | mm | | tr/min | | |
| 54,7 | 49 | 102 | 12 | 12,7 | 6 | 8 | 10 | 2 | 10.000 | 99-PK112P | F03FR02406 |
| 31,75 | 20 | 58 | 12 | - | 2,4 | 9,53 | - | 2 | 18.000 | 99-PK212P | F03FR02408 |
| 31,75 | 23,8 | 72 | 12 | 12,7 | 3,2 | 9,53 | 2,4 | 2 | 18.000 | 99-PK312P | F03FR02409 |
| 44,44 | 29 | 77,1 | 12 | 12,7 | 3 | 10,5 | 7 | 2 | 16.000 | 99-00812P | F03FR02414 |
| 23,8 | 35 | 83,5 | 12 | 12,7 | 4 | 15 | - | 2 | 24.000 | 99-01212P | F03FR02418 |
| 23,8 | 35 | 83,5 | 12 | 12,7 | 3,5 | 4,5 | 8,5 | 2 | 24.000 | 99-01312P | F03FR02419 |

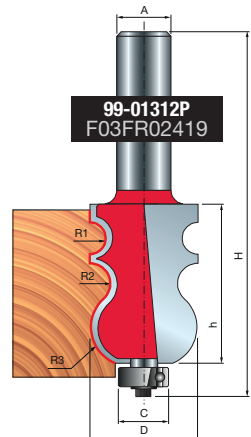
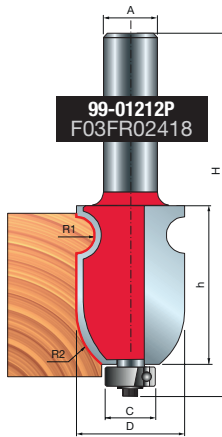
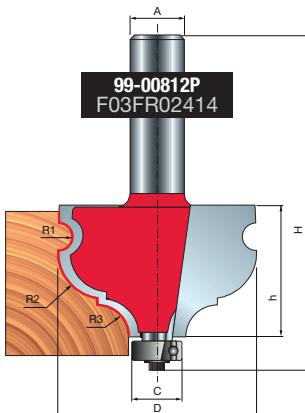
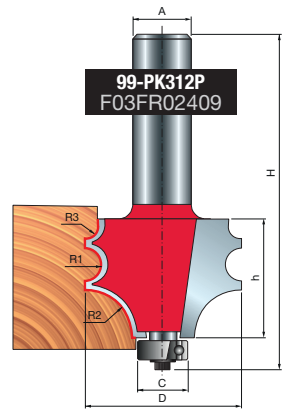
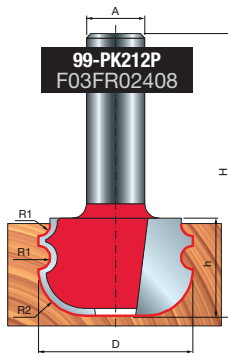
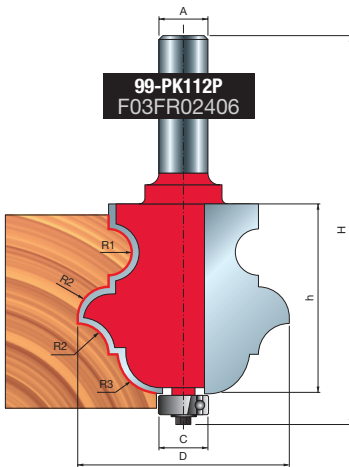

Fraises pour arrondi 85-

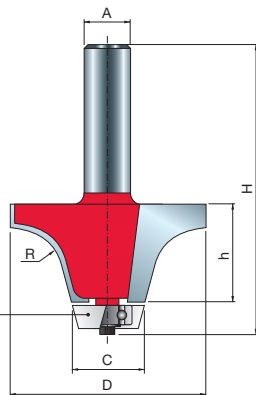

Guide à roulement à billes

| D | h | H | A | C | R | Z | tr/min max. | Code Freud | N° article | |
|------|------|------|----|------|------|------|-------------|------------|------------------|------------|
| mm | mm | mm | mm | inch | mm | mm | tr/min | | | |
| 54 | 25,4 | 74,6 | 12 | | 22,2 | 12,7 | 2 | 16.000 | 85-00112P | F03FR02223 |
| 57,2 | 31,8 | 81 | 12 | | 22,2 | 12,7 | 2 | 12.000 | 85-00312P | F03FR02225 |
| 50,8 | 25,4 | 73,6 | | 1/2 | 19,1 | 12,7 | 2 | 16.000 | 85-00150P | F03FR02224 |

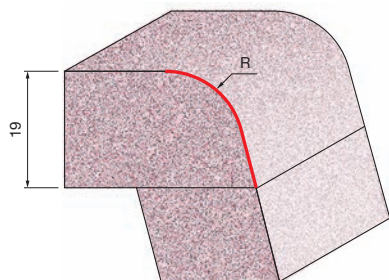
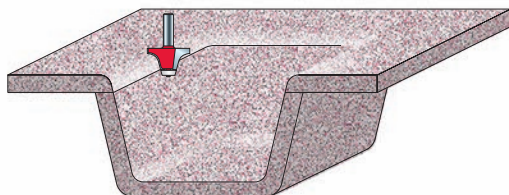

85-00112P
F03FR02223

85-00150P
F03FR02224

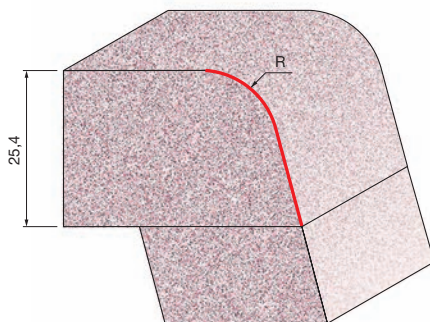

85-00312P
F03FR02225

Fraises pour arrondi en douceur 85-



Guide à roulement à billes

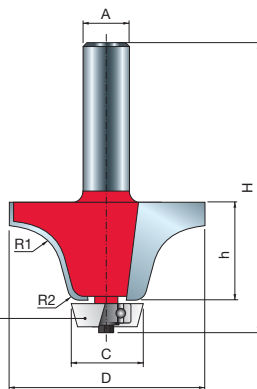

| D | h | H | A | C | R1 | R2 | Z | tr/min max. | Code Freud | N° article |
|------|------|------|----|------|------|------|---|-------------|------------------|------------|
| mm | mm | mm | mm | mm | mm | mm | | tr/min | | |
| 54 | 25,4 | 74,6 | 12 | 19,2 | 12,7 | 6,35 | 2 | 16.000 | 85-00512P | F03FR02226 |
| 57,2 | 31,8 | 80,9 | 12 | 19,2 | 12,7 | 6,35 | 2 | 12.000 | 85-00712P | F03FR02227 |

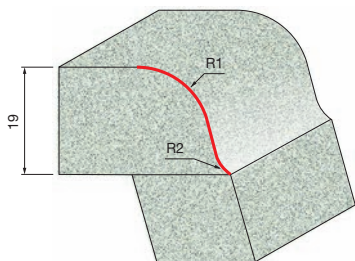
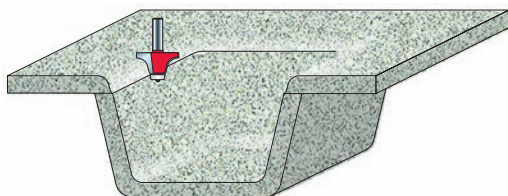

85-00512P
F03FR02226

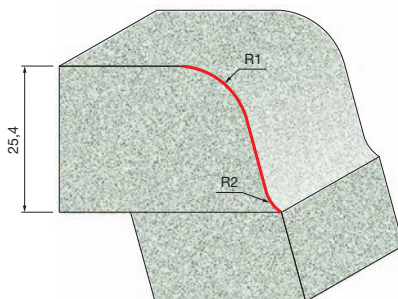

85-00712P
F03FR02227

Fraises pour biseau 85-



Guide à roulement à billes

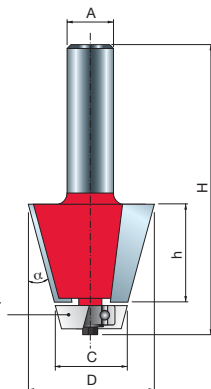

| D | h | H | A | C | α | Z | tr/min max. | Code Freud | N° article |
|------|------|------|----|------|----------|---|-------------|------------|------------|
| mm | mm | mm | mm | mm | | | tr/min | | |
| 35,6 | 25,4 | 78,1 | 12 | 22,2 | 15° | 2 | 16.000 | 85-00912P | F03FR02228 |

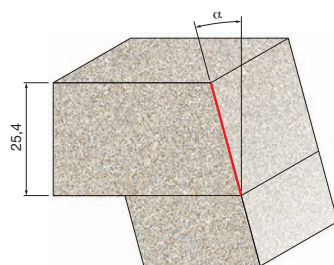
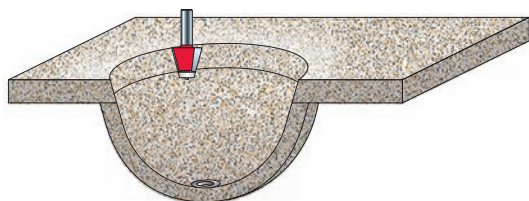

Fraise pour joint ondulé 85-

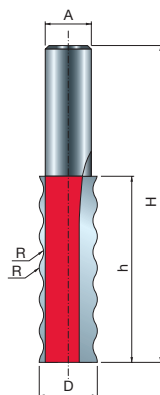
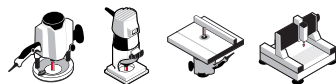

| D | h | H | A | α | Z | tr/min max. | Code Freud | N° article |
|----|------|----|----|----------|---|-------------|------------|------------|
| mm | mm | mm | mm | | | tr/min | | |
| 16 | 51,3 | 88 | 12 | 4 | 2 | 24.000 | 85-03312P | F03FR02229 |

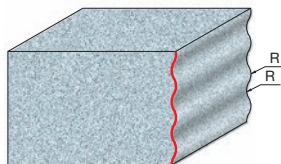



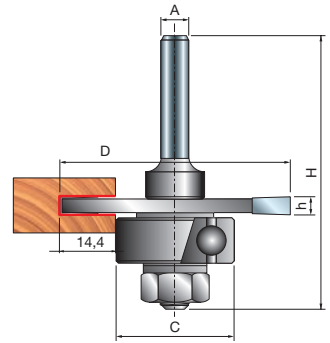

FRAISES D'ASSEMBLAGE

Fraises à rainurer 63-



| D | h | H | A | C | Z | tr/min max. | Code Freud | N° article |
|------|-----|------|----|----|---|-------------|------------------|------------|
| mm | mm | mm | mm | mm | | tr/min | | |
| 50,8 | 1,5 | 60,3 | 6 | 22 | 3 | 24.000 | 63-09906P | F03FR02049 |
| 50,8 | 1,6 | 60,3 | 6 | 22 | 3 | 24.000 | 63-10006P | F03FR02055 |
| 50,8 | 2 | 60,3 | 6 | 22 | 3 | 24.000 | 63-10406P | F03FR02058 |
| 50,8 | 2,4 | 60,3 | 6 | 22 | 3 | 24.000 | 63-10606P | F03FR02061 |
| 50,8 | 2,5 | 60,3 | 6 | 22 | 3 | 24.000 | 63-11306P | F03FR02079 |
| 50,8 | 3 | 60,3 | 6 | 22 | 3 | 24.000 | 63-11406P | F03FR02085 |
| 50,8 | 3,2 | 60,3 | 6 | 22 | 3 | 24.000 | 63-10806P | F03FR02064 |
| 50,8 | 3,5 | 60,3 | 6 | 22 | 3 | 24.000 | 63-11506P | F03FR02091 |
| 50,8 | 4 | 60,3 | 6 | 22 | 3 | 24.000 | 63-10906P | F03FR02067 |
| 50,8 | 4,8 | 60,3 | 6 | 22 | 3 | 24.000 | 63-11006P | F03FR02070 |
| 50,8 | 5 | 60,3 | 6 | 22 | 3 | 24.000 | 63-11606P | F03FR02097 |
| 50,8 | 6 | 60,3 | 6 | 22 | 3 | 24.000 | 63-11106P | F03FR02073 |

| D | h | H | A | C | Z | tr/min max. | Code Freud | N° article |
|------|-----|------|----|----|---|-------------|------------------|------------|
| mm | mm | mm | mm | mm | | tr/min | | |
| 50,8 | 6,4 | 60,3 | 6 | 22 | 3 | 24.000 | 63-11206P | F03FR02076 |
| 50,8 | 1,5 | 60,3 | 8 | 22 | 3 | 24.000 | 63-09908P | F03FR02052 |
| 50,8 | 2,5 | 60,3 | 8 | 22 | 3 | 24.000 | 63-11308P | F03FR02082 |
| 50,8 | 3 | 60,3 | 8 | 22 | 3 | 24.000 | 63-11408P | F03FR02088 |
| 50,8 | 3,5 | 60,3 | 8 | 22 | 3 | 24.000 | 63-11508P | F03FR02094 |
| 50,8 | 5 | 60,3 | 8 | 22 | 3 | 24.000 | 63-11608P | F03FR02100 |
| 50,8 | 1,5 | 60,3 | 12 | 22 | 3 | 24.000 | 63-14912P | F03FR02105 |
| 50,8 | 1,6 | 60,3 | 12 | 22 | 3 | 24.000 | 63-15012P | F03FR02108 |
| 50,8 | 2 | 60,3 | 12 | 22 | 3 | 24.000 | 63-15412P | F03FR02111 |
| 50,8 | 2,4 | 60,3 | 12 | 22 | 3 | 24.000 | 63-15612P | F03FR02114 |
| 50,8 | 2,5 | 60,3 | 12 | 22 | 3 | 24.000 | 63-16312P | F03FR02132 |
| 50,8 | 3 | 60,3 | 12 | 22 | 3 | 24.000 | 63-16412P | F03FR03241 |
| 50,8 | 3,2 | 60,3 | 12 | 22 | 3 | 24.000 | 63-15812P | F03FR02117 |
| 50,8 | 3,5 | 60,3 | 12 | 22 | 3 | 24.000 | 63-16512P | F03FR02137 |
| 50,8 | 4 | 60,3 | 12 | 22 | 3 | 24.000 | 63-15912P | F03FR02120 |
| 50,8 | 4,8 | 60,3 | 12 | 22 | 3 | 24.000 | 63-16012P | F03FR02123 |
| 50,8 | 5 | 60,3 | 12 | 22 | 3 | 24.000 | 63-16612P | F03FR02140 |
| 50,8 | 6 | 60,3 | 12 | 22 | 3 | 24.000 | 63-16112P | F03FR02126 |
| 50,8 | 6,4 | 60,3 | 12 | 22 | 3 | 24.000 | 63-16212P | F03FR02129 |

| | Pièces détachées | Dimensions mm | Code Freud | N° article |
|---|--------------------|------------------|------------------|------------|
|  | Rondelle | 17 x 8,4 x 1,6 | 2617M AG9 | F03F010005 |
|  | Écrou hexagonal | 7,94 x 6,75 | 2610M BB9 | F03F010003 |
|  | Roulement à billes | 22 x 8 x 7,1 | 3102M AC9 | F03F010008 |

Couteaux à rainurer 56- 58-



Z = 3

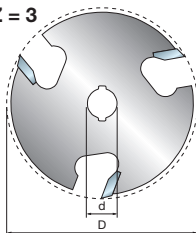

Z = 4

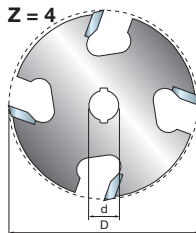

| D | h | d | Z | tr/min max. | Code Freud | N° article |
|------|-----|----|---|-------------|------------------|------------|
| mm | mm | mm | | tr/min | | |
| 50,8 | 1,5 | 8 | 3 | 24.000 | 56-09908P | F03FR02014 |
| 50,8 | 1,6 | 8 | 3 | 16.000 | 56-10008P | F03FR02015 |
| 50,8 | 2 | 8 | 3 | 24.000 | 56-10408P | F03FR02016 |
| 50,8 | 2,4 | 8 | 3 | 16.000 | 56-10608P | F03FR02017 |
| 50,8 | 2,5 | 8 | 3 | 24.000 | 56-11308P | F03FR02028 |
| 50,8 | 3 | 8 | 3 | 24.000 | 56-11408P | F03FR02029 |
| 50,8 | 3,2 | 8 | 3 | 24.000 | 56-10808P | F03FR02019 |
| 50,8 | 3,5 | 8 | 3 | 24.000 | 56-11508P | F03FR02030 |
| 50,8 | 4 | 8 | 3 | 24.000 | 56-10908P | F03FR02021 |
| 50,8 | 4,8 | 8 | 3 | 24.000 | 56-11008P | F03FR02023 |
| 50,8 | 5 | 8 | 3 | 24.000 | 56-11608P | F03FR02031 |
| 50,8 | 6 | 8 | 3 | 24.000 | 56-11108P | F03FR02025 |
| 50,8 | 6,4 | 8 | 3 | 24.000 | 56-11208P | F03FR02026 |

| D | h | d | Z | tr/min max. | Code Freud | N° article |
|------|-----|----|---|-------------|------------------|------------|
| mm | mm | mm | | tr/min | | |
| 50,8 | 1,5 | 8 | 4 | 16.000 | 58-09908P | F03FR02032 |
| 50,8 | 2 | 8 | 4 | 16.000 | 58-10408P | F03FR02033 |
| 50,8 | 2,5 | 8 | 4 | 16.000 | 58-11308P | F03FR02036 |
| 50,8 | 3 | 8 | 4 | 16.000 | 58-11408P | F03FR02037 |
| 50,8 | 5 | 8 | 4 | 24.000 | 58-11608P | F03FR02038 |
| 50,8 | 6 | 8 | 4 | 16.000 | 58-11108P | F03FR02034 |

Arbres pour fraises à rainurer

60-



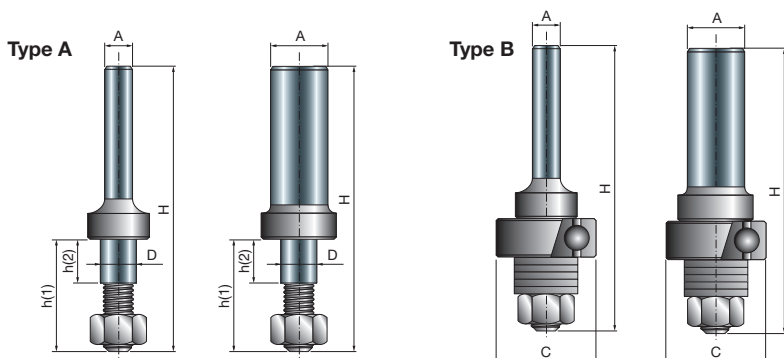

| D | h1 | h2 | H | C | A | tr/min max. | Code Freud | N° article |
|------|------|----|------|----|-----|-------------|------------------|------------|
| mm | mm | mm | mm | mm | mm | tr/min | | |
| 7,94 | 24,6 | 10 | 60,3 | - | 6 | 24.000 | 60-10006P | F03FR02039 |
| 7,94 | 24,6 | 10 | 60,3 | 22 | 6 | 24.000 | 60-12006P | F03FR02044 |
| 7,94 | 24,6 | 10 | 60,3 | - | 8 | 24.000 | 60-10008P | F03FR02040 |
| 7,94 | 24,6 | 10 | 60,3 | 22 | 8 | 24.000 | 60-12008P | F03FR02045 |
| 7,94 | 24,6 | 10 | 60,3 | - | 12 | 24.000 | 60-10212P | F03FR02042 |
| 7,94 | 24,6 | 10 | 60,3 | 22 | 12 | 24.000 | 60-12212P | F03FR02046 |
| 7,94 | 24,6 | 10 | 60,3 | - | 1/4 | 24.000 | 60-10025P | F03FR02041 |
| 7,94 | 24,6 | 10 | 60,3 | - | 1/2 | 24.000 | 60-10250P | F03FR02043 |





Type A

60-10006P - 60-10008P - 60-10212P - 60-10025P - 60-10250P

| | Quantité | Pièces détachées | Dimensions mm | Code Freud | N° article |
|---|----------|------------------|------------------|------------------|------------|
|  | 7 | Rondelle | 17 x 8,4 x 1,6 | 2617M AG9 | F03F010005 |
|  | 1 | Écrou hexagonal | 7,94 x 6,75 | 2610M BB9 | F03F010003 |

Type B

60-12006P - 60-12008P - 60-12212P

| | Quantité | Pièces détachées | Dimensions mm | Code Freud | N° article |
|---|----------|--------------------|------------------|------------------|------------|
|  | 5 | Rondelle | 17 x 8,4 x 1,6 | 2617M AG9 | F03F010005 |
|  | 1 | Écrou hexagonal | 7,94 x 6,75 | 2610M BB9 | F03F010003 |
|  | 1 | Roulement à billes | 22 x 8 x 7 | 3102M AC9 | F03F010008 |

Fraises à rainurer pour assemblage à lamelles 63-

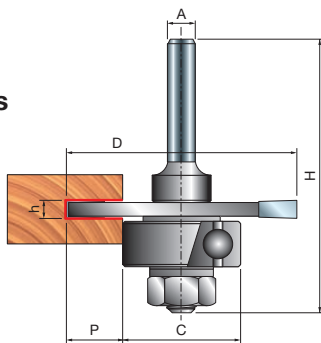

| D | h | H | C | P | A | Z | tr/min max. | Code Freud | N° article | |
|------|------|------|----------|---------------|----|------|-------------|------------------|------------------|------------|
| mm | mm | mm | mm | mm | mm | inch | tr/min | | | |
| 50,8 | 3,97 | 60,3 | 26-30-34 | 12,4-10,4-8,4 | 6 | 3 | 24.000 | 63-60906P | F03FR02143 | |
| 50,8 | 3,97 | 60,3 | 26-30-34 | 12,4-10,4-8,4 | 8 | 3 | 24.000 | 63-60908P | F03FR02146 | |
| 50,8 | 3,97 | 60,3 | 26-30-34 | 12,4-10,4-8,4 | 12 | 3 | 24.000 | 63-60912P | F03FR02149 | |
| 50,8 | 3,97 | 60,3 | 26-30-34 | 12,4-10,4-8,4 | | 1/4 | 3 | 24.000 | 63-60925P | F03FR02152 |
| 50,8 | 3,97 | 60,3 | 26-30-34 | 12,4-10,4-8,4 | | 1/2 | 3 | 24.000 | 63-60950P | F03FR02155 |

| Pièces détachées | Dimensions mm | Code Freud | N° article |
|------------------|--------------------|------------|------------|
| | Écrou hexagonal | 2610M BB9 | F03F010003 |
| | Rondelle | 2617M AG9 | F03F010005 |
| | Rondelle | 2617M BG9 | F03FR01668 |
| | Roulement à billes | RB62M 1249 | F03F011417 |
| | Roulement à billes | RB62M 1289 | F03F011418 |
| | Roulement à billes | RB62ME DA9 | F03FR01146 |

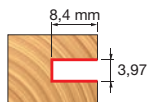
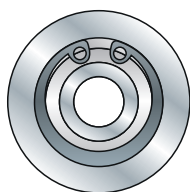

Avec roulement **RB62M 1249**
(34 mm)



Taille de lamelle-00
47 mm x 15 mm

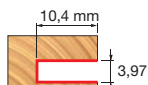
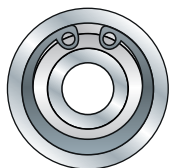
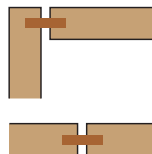

Avec roulement **RB62M 1289**
(30 mm)



Taille de lamelle-10
54 mm x 19 mm

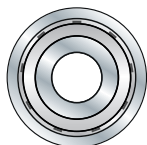

Avec roulement **RB62ME DA9**
(26 mm)



Taille de lamelle-20
59 mm x 22 mm

Jeu de fraises à languette et rainure ajustables

99-

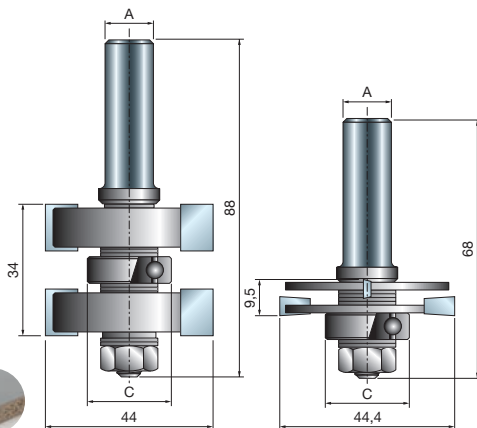

| D | h | H | A | C | Z | tr/min max. | Code Freud | N° article |
|------|-----|----|----|----|---|-------------|------------------|------------|
| mm | mm | mm | mm | mm | | tr/min | | |
| 44 | 34 | 88 | 12 | 22 | 2 | 16.000 | 99-03612P | F03FR02432 |
| 44,4 | 9,5 | 68 | 12 | 22 | 2 | | | |

| Qté | Pièces détachées | Dimensions mm | Code Freud | N° article |
|-----|--------------------|----------------|-------------------|------------|
| 2 | Écrou hexagonal | 7,94 x 6,75 | 2610M BB9 | F03F010003 |
| 2 | Rondelle | 14 x 8,4 x 1,6 | 2617M BG9 | F03FR01668 |
| 2 | Roulement à billes | 22 x 8 x 7,1 | 3102M AC9 | F03F010008 |
| 4 | Bague de calage | 18 x 0,1 x 8 | AN01MP0019 | F03FC00392 |
| 4 | Bague de calage | 18 x 0,2 x 8 | AN01MP0029 | F03FC00393 |
| 2 | Bague de calage | 18 x 0,5 x 8 | AN01MP0059 | F03FC00395 |
| 8 | Bague de calage | 18 x 1 x 8 | AN01MP0109 | F03FC00396 |
| 4 | Bague de calage | 18 x 0,15 x 8 | AN01MPAA99 | F03FC00391 |

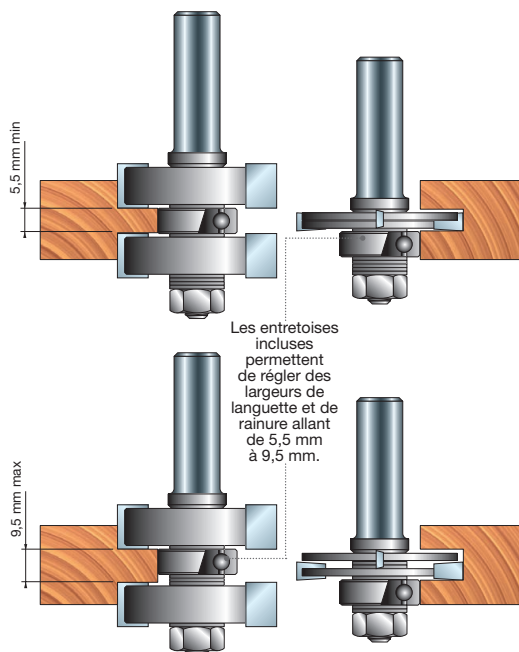

Fraises à feuillure 32-

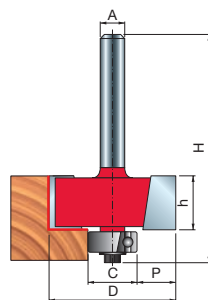

| D | h | H | A | C | R | Z | tr/min max. | Code Freud | N° article |
|-------|------|------|----|------|------|------|-------------|------------|-----------------------------|
| mm | mm | mm | mm | inch | mm | mm | tr/min | | |
| 31,75 | 13,2 | 55,7 | 6 | | 12,7 | 9,52 | 2 | 18.000 | 32-10006P F03FR01745 |
| 34,92 | 12,7 | 54,4 | 6 | | 12,7 | 11,1 | 2 | 16.000 | 32-50006P F03FR01750 |
| 31,75 | 13,2 | 55,7 | 8 | | 12,7 | 9,52 | 2 | 18.000 | 32-10008P F03FR01746 |
| 34,92 | 12,7 | 54,7 | 8 | | 12,7 | 11,1 | 2 | 16.000 | 32-50008P F03FR01751 |
| 31,75 | 13,2 | 61,7 | 12 | | 12,7 | 9,52 | 2 | 18.000 | 32-10212P F03FR01748 |
| 34,92 | 12,7 | 60,7 | 12 | | 12,7 | 11,1 | 2 | 16.000 | 32-52012P F03FR01758 |
| 31,75 | 13,2 | 55,7 | | 1/4 | 12,7 | 9,52 | 2 | 18.000 | 32-10025P F03FR01747 |
| 31,75 | 13,2 | 61,7 | | 1/2 | 12,7 | 9,52 | 2 | 18.000 | 32-10250P F03FR01749 |







Fraises à feuillurer avec roulements











Fraises à feuillurer avec un jeu de 4 roulements à billes

| D | h | H | A | C | P | Z | tr/min max. | Code Freud | N° article |
|-------|------|------|----|------|------------|-----------|-------------|------------|-----------------------------|
| mm | mm | mm | mm | inch | mm | mm | tr/min | | |
| 34,92 | 12,7 | 54,4 | 6 | | 9,53-19,05 | 7,94-12,7 | 2 | 16.000 | 32-50206P F03FR01752 |
| 34,92 | 12,7 | 54,4 | 8 | | 9,53-19,05 | 7,94-12,7 | 2 | 16.000 | 32-50208P F03FR01753 |
| 34,92 | 12,7 | 60,7 | 12 | | 9,53-19,05 | 7,94-12,7 | 2 | 16.000 | 32-52212P F03FR01759 |
| 34,92 | 12,7 | 60,7 | | 1/2 | 9,53-15,88 | 9,53-12,7 | 2 | 16.000 | 32-52250P F03FR01760 |

Fraises à feuillurer avec un jeu de 7 roulements à billes

| D | h | H | A | C | P | Z | tr/min max. | Code Freud | N° article |
|-------|------|------|----|------------|--------|---|-------------|------------------|------------|
| mm | mm | mm | mm | mm | mm | | tr/min | | |
| 34,92 | 12,7 | 54,7 | 6 | 9,53-34,92 | 0-12,7 | 2 | 16.000 | 32-50406P | F03FR01755 |
| 34,92 | 12,7 | 54,4 | 8 | 9,53-34,92 | 0-12,7 | 2 | 16.000 | 32-50408P | F03FR01756 |
| 34,92 | 12,7 | 60,7 | 12 | 9,53-34,92 | 0-12,7 | 2 | 16.000 | 32-52412P | F03FR01761 |

| | Pièces détachées | Dimensions mm | Code Freud | N° article |
|------------------|--|---------------------|------------------|------------|
| |  Vis | M3 x 7,6 | 2607M 001 | F03F010000 |
| |  Clé mâle six pans | 2,5 | 2619M CA9 | F03FA07432 |
| |  Rondelle | 9 x 2 x 6 | FX07M AA9 | F03F010158 |
| |  Rondelle | 12 x 1,1 x 4,8 | FX07M AB9 | F03F010159 |
| 32-52250P |  Roulement à billes | 9,53 x 3,2 x 4,76 | 3102M AA9 | F03F010006 |
| |  Roulement à billes | 12,7 x 4,98 x 4,76 | 3102M AB9 | F03F010007 |
| |  Roulement à billes | 15,88 x 4,97 x 4,76 | 3102M AJ9 | F03F010014 |

| | | Pièces détachées | Dimensions mm | Code Freud | N° article |
|-------------------------------------|---|----------------------|---------------------|-------------------|------------|
| 32-50206P 32-50208P 32-52212P |  | Roulement à billes | 9,53 x 3,2 x 4,76 | 3102M AA9 | F03F010006 |
| |  | Roulement à billes | 12,7 x 4,98 x 4,76 | 3102M AB9 | F03F010007 |
| |  | Roulement à billes | 15,88 x 4,97 x 4,76 | 3102M AJ9 | F03F010014 |
| |  | Roulement à billes / | 19,05 x 8 x 4,76 | RB62M 1509 | F03F011422 |
| 32-50406P 32-50408P 32-52412P |  | Roulement à billes | 9,53 x 3,2 x 4,76 | 3102M AA9 | F03F010006 |
| |  | Roulement à billes | 12,7 x 4,98 x 4,76 | 3102M AB9 | F03F010007 |
| |  | Roulement à billes | 15,88 x 4,97 x 4,76 | 3102M AJ9 | F03F010014 |
| |  | Roulement à billes | 19,05 x 8 x 4,76 | RB62M 1509 | F03F011422 |
| |  | Roulement à billes | 22,22 x 8 x 4,76 | RB62M 1529 | F03F011423 |
| |  | Roulement à billes | 28,58 x 8 x 4,76 | RB62M 1549 | F03F011424 |
| |  | Roulement à billes | 34,92 x 8 x 4,76 | RB62M 1569 | F03F011425 |

Fraise pour trou de serrure 70-

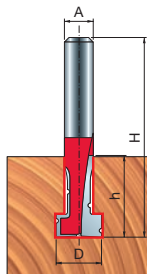
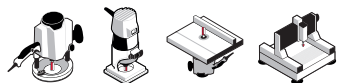

| D | h | H | A | Z | tr/min max. | Code Freud | N° article |
|----|----|------|----|---|-------------|------------------|------------|
| mm | mm | mm | mm | | tr/min | | |
| 10 | 17 | 48,2 | 6 | 2 | 24.000 | 70-10406P | F03FR02159 |



Exemple de trou de serrure

Fraises en « T » 52-

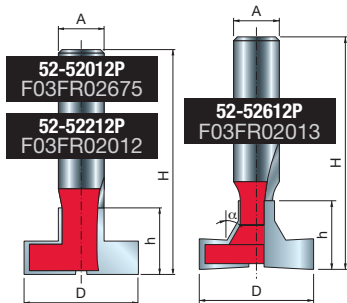
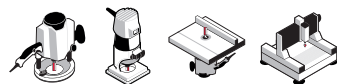

| D | h | H | A | α | Z | tr/min max. | Code Freud | N° article |
|-------|------|------|----|----------|---|-------------|------------------|------------|
| mm | mm | mm | mm | | | tr/min | | |
| 28 | 16 | 59 | 12 | - | 2 | 22.000 | 52-52012P | F03FR02675 |
| 28,58 | 20,6 | 63,5 | 12 | - | 2 | 18.000 | 52-52212P | F03FR02012 |
| 30 | 18 | 61 | 12 | 30° | 2 | 18.000 | 52-52612P | F03FR02013 |

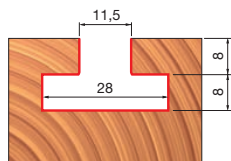

52-52012P
F03FR02675

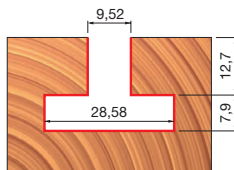

52-52212P
F03FR02012

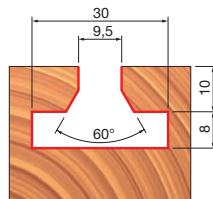

52-52612P
F03FR02013

Fraises queue d'aronde 22-

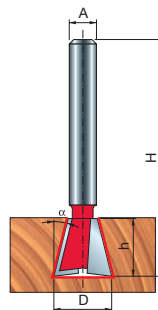
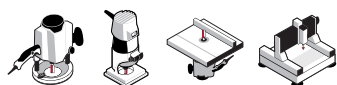

| D | h | H | A | α | Z | tr/min max. | Code Freud | N° article |
|-------|------|------|----|----------|---|-------------|------------------|------------|
| mm | mm | mm | mm | inch | | tr/min | | |
| 9,52 | 10,5 | 47,5 | 6 | | 2 | 24.000 | 22-10206P | F03FR01640 |
| 12,7 | 12,7 | 50,7 | 6 | | 2 | 24.000 | 22-10406P | F03FR01643 |
| 15,88 | 22,2 | 54,2 | 6 | | 2 | 24.000 | 22-10506P | F03FR01646 |
| 19,05 | 22,2 | 54,2 | 6 | | 2 | 24.000 | 22-10606P | F03FR01648 |
| 9,52 | 10,5 | 47,5 | 8 | | 2 | 24.000 | 22-10208P | F03FR01641 |
| 12,7 | 12,7 | 50,7 | 8 | | 2 | 24.000 | 22-10408P | F03FR01644 |
| 15,88 | 22,2 | 54,2 | 8 | | 2 | 24.000 | 22-10508P | F03FR01647 |
| 19,05 | 22,2 | 54,2 | 8 | | 2 | 24.000 | 22-10608P | F03FR01649 |
| 12,7 | 12,7 | 59,7 | 12 | | 2 | 24.000 | 22-11212P | F03FR01650 |
| 19,05 | 22,2 | 66,7 | 12 | | 2 | 24.000 | 22-11412P | F03FR01653 |
| 9,52 | 9,9 | 44,9 | | 1/4 | 2 | 24.000 | 22-10225P | F03FR01642 |
| 12,7 | 12,7 | 50,7 | | 1/4 | 2 | 24.000 | 22-10425P | F03FR01645 |
| 12,7 | 12,7 | 59,7 | | 1/2 | 2 | 24.000 | 22-11250P | F03FR01651 |

Fraises à onglet à 45° 99-

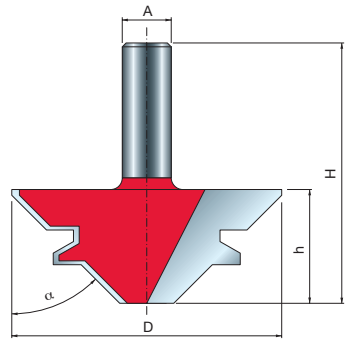
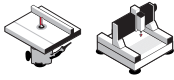

| D | h | H | A | α | Z | tr/min max. | Code Freud | N° article |
|----|------|------|----|----------|---|-------------|------------------|------------|
| mm | mm | mm | mm | | | tr/min | | |
| 55 | 23 | 61 | 12 | 45° | 2 | 16.000 | 99-03512P | F03FR02425 |
| 70 | 29,5 | 67,5 | 12 | 45° | 2 | 12.000 | 99-03412P | F03FR02424 |

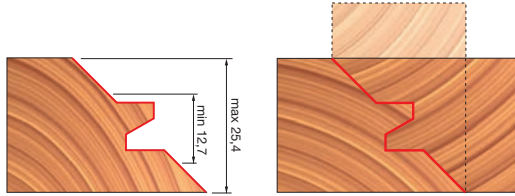

Assemblage simple

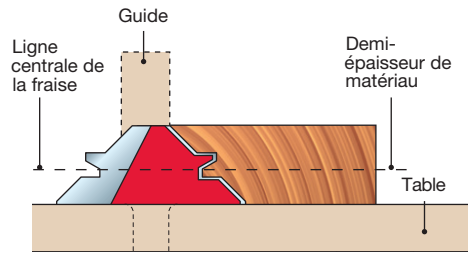
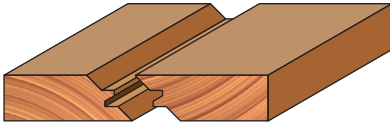

Assemblage à onglet à 45°

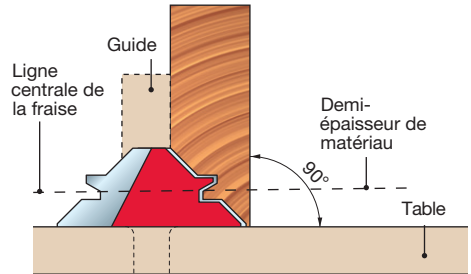
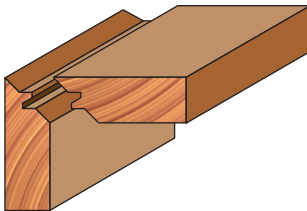

Jeu de 2 fraises à onglet à 22,5° 99-

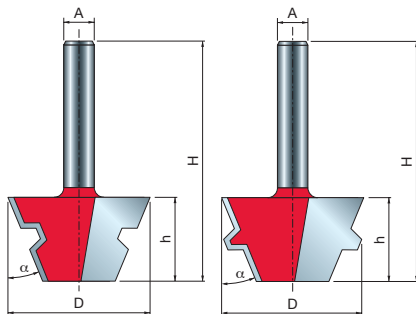
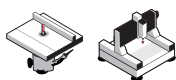

| D | h | H | A | α | Z | tr/min max. | Code Freud | N° article |
|------|------|------|----|----------|---|-------------|------------------|------------|
| mm | mm | mm | mm | | | tr/min | | |
| 37,3 | 22,2 | 54,2 | 8 | 22,5° | 2 | 24.000 | 99-04308P | F03FR02450 |

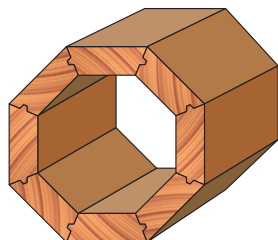
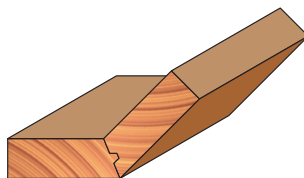
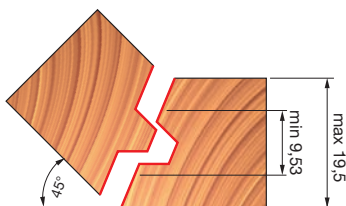
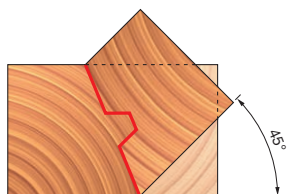

Fraises pour joint collé réversible 99-

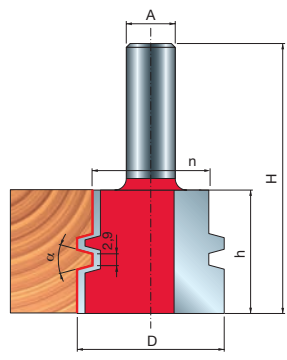
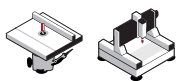

| D | h | H | n | A | α | Z | tr/min max. | Code Freud | N° article |
|----|----|----|------|-----|----------|---|-------------|------------|------------|
| mm | mm | mm | mm | mm | inch | | tr/min | | |
| 38 | 32 | 70 | 30,2 | 12 | 15° | 2 | 16.000 | 99-03112P | F03FR02422 |
| 38 | 32 | 70 | 30,2 | 1/2 | 15° | 2 | 16.000 | 99-03150P | F03FR02423 |

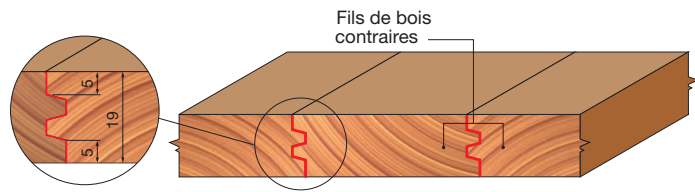

Fraise pour bouvetage 99-

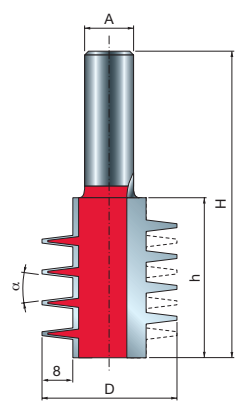
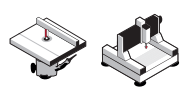

| D | h | H | A | α | Z | tr/min max. | Code Freud | N° article |
|----|------|------|----|----------|---|-------------|------------|------------|
| mm | mm | mm | mm | | | tr/min | | |
| 35 | 41,5 | 79,5 | 12 | 14° | 2 | 16.000 | 99-03712P | F03FR02440 |

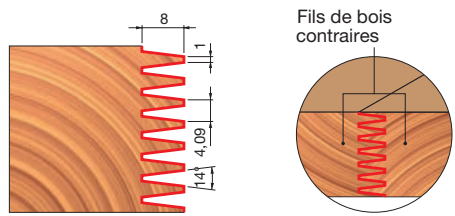

Fraise à bouveter avec roulement supérieur - type A 99-

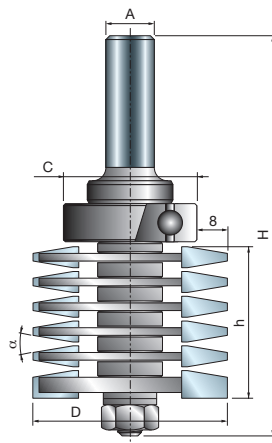

| D | h | H | A | C | α | Z | tr/min max. | Code Freud | N° article |
|------|------|-----|----|----|----------|---|-------------|------------------|------------|
| mm | mm | mm | mm | mm | | | tr/min | | |
| 50,8 | 45,2 | 108 | 12 | 35 | 20° | 2 | 24.000 | 99-03912P | F03FR02444 |

| | Pièces détachées | Dimensions mm | Code Freud | N° article |
|--|--------------------|------------------|-------------------|------------|
| | Écrou hexagonal | 7,94 x 6,75 | 2610M BB9 | F03F010003 |
| | Rondelle | 14 x 8,4 x 1,6 | 2617M BG9 | F03FR01668 |
| | Roulement à billes | 35 x 15 x 11 | 3102M AI9 | F03F012285 |
| | Bague de calage | 18 x 0,1 x 8 | AN01MP0019 | F03FC00392 |
| | Bague de calage | 18 x 1 x 8 | AN01MP0109 | F03FC00396 |
| | Bague de calage | 18 x 2,5 x 8 | AN01MP0259 | F03FC00398 |
| | Bague de calage | 18 x 4,4 x 8 | AN01MP0449 | F03FC00399 |

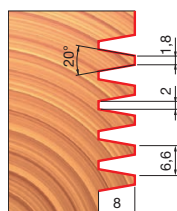

Fils de bois contraires

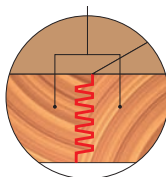

Fraise à bouveter avec roulement supérieur - type B 99-

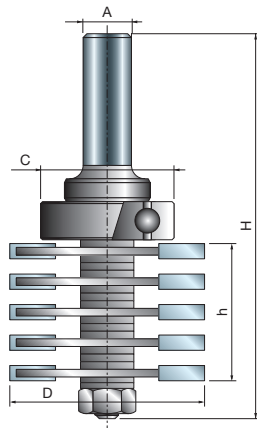

| D | h | H | A | C | Z | tr/min max. | Code Freud | N° article |
|----|----|-----|----|----|---|-------------|------------------|------------|
| mm | mm | mm | mm | mm | | tr/min | | |
| 47 | 36 | 101 | 12 | 28 | 2 | 24.000 | 99-04212P | F03FR02447 |

| | Pièces détachées | Dimensions mm | Code Freud | N° article |
|--|--------------------|----------------|-------------------|------------|
| | Écrou hexagonal | 7,94 x 6,75 | 2610M BB9 | F03F010003 |
| | Rondelle | 14 x 8,4 x 1,6 | 2617M BG9 | F03FR01668 |
| | Roulement à billes | 28 x 12 x 8 | 3102M AH9 | F03F010013 |
| | Bague de calage | 18 x 0,2 x 8 | AN01MP0029 | F03FC00393 |
| | Bague de calage | 18 x 1 x 8 | AN01MP0109 | F03FC00396 |
| | Bague de calage | 18 x 0,5 x 8 | AN01MP0059 | F03FC00395 |
| | Bague de calage | 18 x 4,4 x 8 | AN01MP0449 | F03FC00399 |

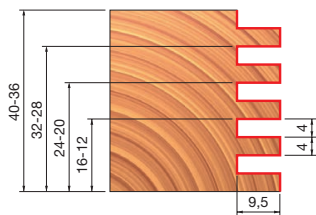

Fils de bois contraires

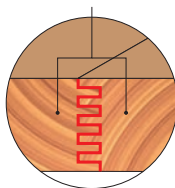

Fraise pour assemblage de tiroir 99-

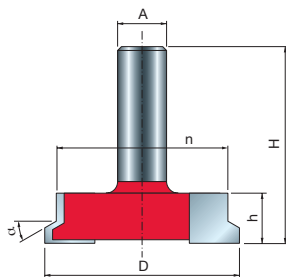

| D | h | H | A | n | α | Z | tr/min max. | Code Freud | N° article |
|------|----|----|----|------|----------|---|-------------|------------|------------|
| mm | mm | mm | mm | mm | | | tr/min | | |
| 50,5 | 13 | 49 | 12 | 44,5 | 30° | 2 | 16.000 | 99-24012P | F03FR02463 |

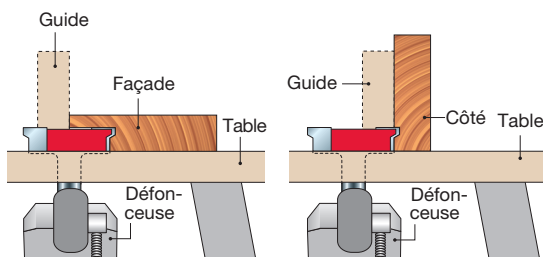
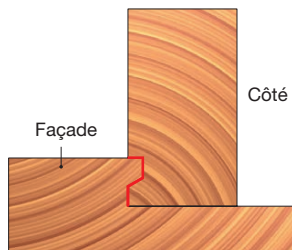
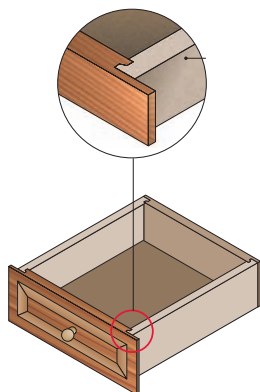

Fraise pour poignée à tirer

99-

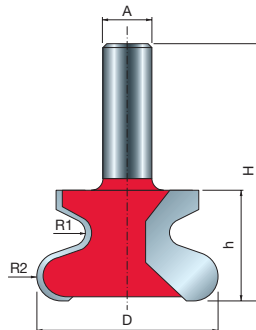

| D | h | H | A | R1 | R2 | Z | tr/min max. | Code Freud | N° article |
|----|------|------|----|-----|------|---|-------------|------------|------------|
| mm | mm | mm | mm | mm | mm | | tr/min | | |
| 47 | 28,7 | 66,7 | 12 | 3,2 | 6,35 | 2 | 16.000 | 99-00712P | F03FR02413 |

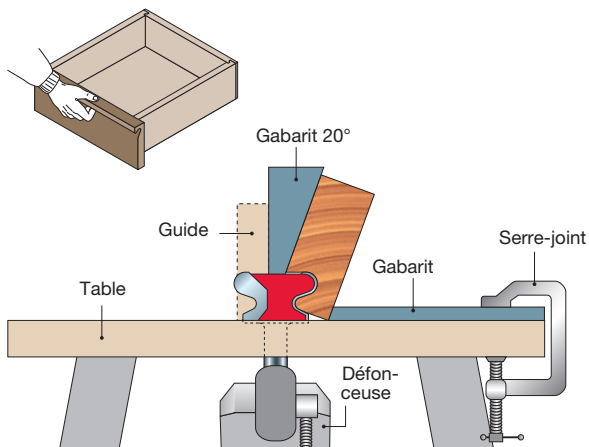
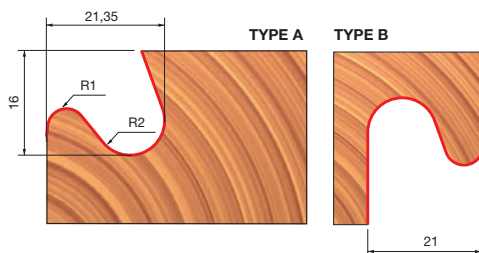

Fraises de profils et contre-profils assortis

99-



| D | H | A | R1 | R2 | C | Z | tr/min max. | Code Freud | N° article |
|------|----|-----|------|-----|----|----|-------------|------------------|------------|
| mm | mm | mm | inch | mm | mm | mm | tr/min | | |
| 42,9 | 77 | 12 | 5,5 | - | 22 | 2 | 24.000 | 99-26012P | F03FR02468 |
| 42,9 | 77 | 12 | 4,5 | 5,5 | 22 | 2 | 24.000 | 99-26112P | F03FR02478 |
| 42,9 | 77 | 12 | 7 | - | 22 | 2 | 24.000 | 99-26312P | F03FR02488 |
| 42,9 | 77 | 1/2 | 4,5 | 5,5 | 22 | 2 | 24.000 | 99-26150P | F03FR02483 |
| 42,9 | 77 | 1/2 | 7 | - | 22 | 2 | 24.000 | 99-26350P | F03FR02493 |

| | Pièces détachées | Dimensions mm | Code Freud | N° article |
|--|--------------------|------------------|-------------------|------------|
| | Écrou hexagonal | 7,94 x 6,75 | 2610M BB9 | F03F010003 |
| | Bague de calage | 18 x 0,1 x 8 | AN01MP0019 | F03FC00392 |
| | Bague de calage | 18 x 0,2 x 8 | AN01MP0029 | F03FC00393 |
| | Bague de calage | 18 x 0,5 x 8 | AN01MP0059 | F03FC00395 |
| | Bague de calage | 18 x 1 x 8 | AN01MP0109 | F03FC00396 |
| | Roulement à billes | 22 x 8 x 7,1 | 3102M AC9 | F03F010008 |

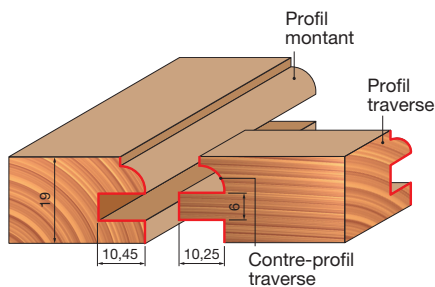
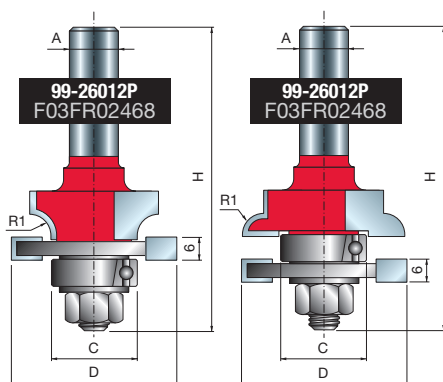

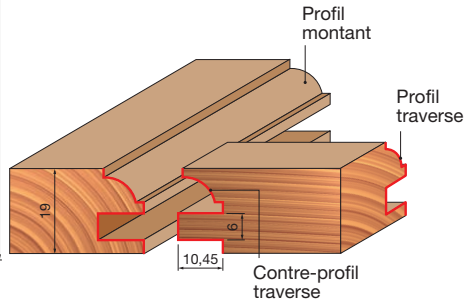
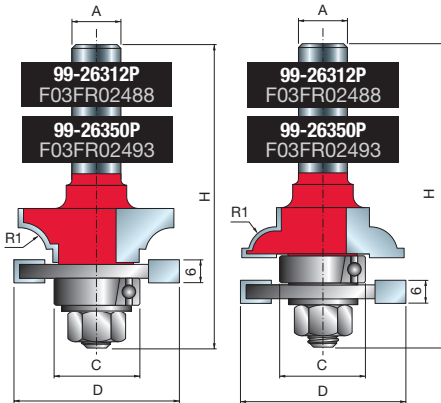
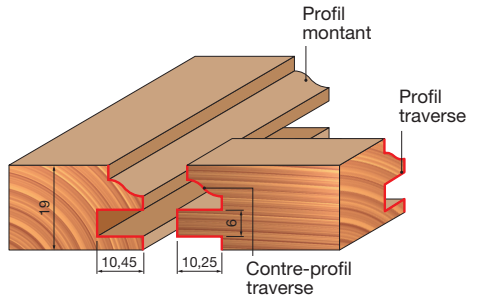
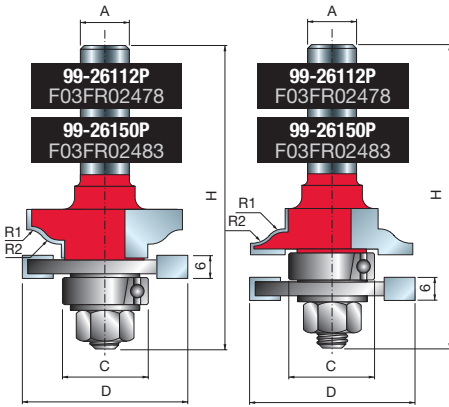

Fraises de profils et contre-profils assortis

99-



| D | h | H | A | R1 | R2 | C | Z | tr/min max. | Code Freud | N° article |
|------|------|-----|-----|------|-----|----|----|-------------|------------------|------------|
| mm | mm | mm | mm | inch | mm | mm | mm | tr/min | | |
| 50,4 | 32,7 | 104 | 12 | 5,5 | - | 32 | 2 | 14.000 | 99-29012P | F03FR02494 |
| 50,4 | 32,7 | 104 | 12 | 5,5 | 4,5 | 32 | 2 | 14.000 | 99-29112P | F03FR02496 |
| 50,4 | 32,7 | 104 | 12 | 7 | - | 32 | 2 | 14.000 | 99-29312P | F03FR02498 |
| 50,4 | 32,7 | 104 | 1/2 | 5,5 | - | 32 | 2 | 14.000 | 99-29050P | F03FR02495 |
| 50,4 | 32,7 | 104 | 1/2 | 7 | - | 32 | 2 | 14.000 | 99-29350P | F03FR02499 |

| | Pièces détachées | Dimensions mm | Code Freud | N° article |
|--|--------------------|---------------|-------------------|------------|
| | Écrou hexagonal | 7,94 x 6,75 | 2610M BB9 | F03F010003 |
| | Anneau de retenue | 15 x 13,9 | 2621ME 015 | F03FA07444 |
| | Roulement à billes | 32 x 15 x 9 | 3102M AN9 | F03F010016 |
| | Bague de calage | 18 x 1 x 8 | AN01MP0109 | F03FC00396 |

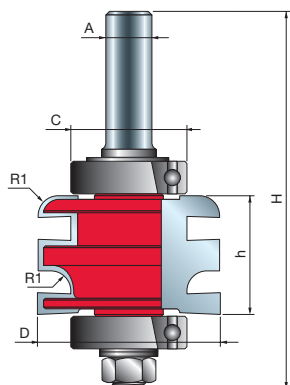

99-29012P
F03FR02494

99-29050P
F03FR02495

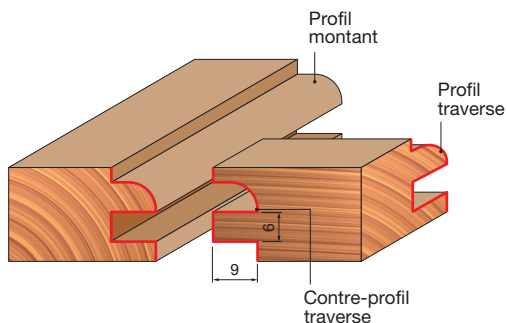

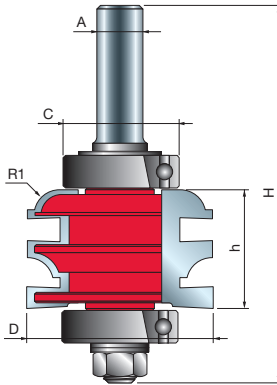
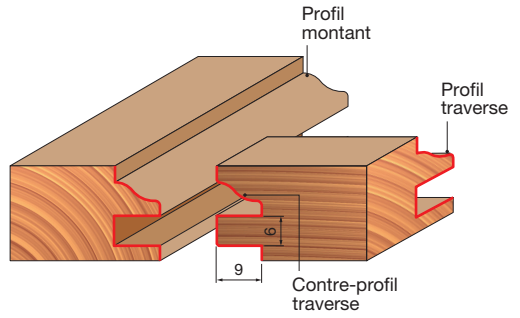
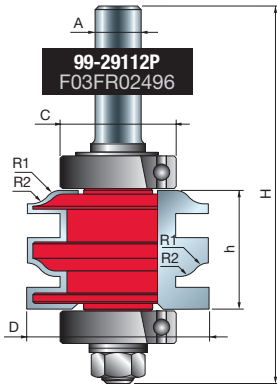

99-29312P
F03FR02498

99-29350P
F03FR02499

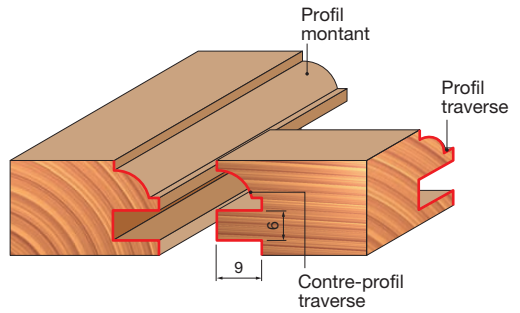

Fraises pour fenêtres à guillotine

99-



| D | h | H | A | m | C | R | Z | tr/min max. | Code Freud | N° article |
|----|------|------|----|------|----|----|---|-------------|------------------|------------|
| mm | mm | mm | mm | mm | mm | mm | | tr/min | | |
| 34 | 35,9 | 78,4 | 12 | 14,5 | 22 | 6 | 2 | 16.000 | 99-05112P | F03FR02455 |
| 38 | 15,5 | 53,5 | 12 | - | - | 6 | 2 | 16.000 | 99-05012P | F03FR02451 |

| | Pièces détachées | Dimensions mm | Code Freud | N° article |
|--|--------------------|------------------|-------------------|------------|
| | Écrou hexagonal | 7,94 x 6,75 | 2610M BB9 | F03F010003 |
| | Rondelle | 14 x 8,4 x 1,6 | 2617M BG9 | F03FR01668 |
| | Roulement à billes | 22 x 8 x 7,1 | 3102M AC9 | F03F010008 |
| | Bague de calage | 18 x 0,1 x 8 | AN01MP0019 | F03FC00392 |

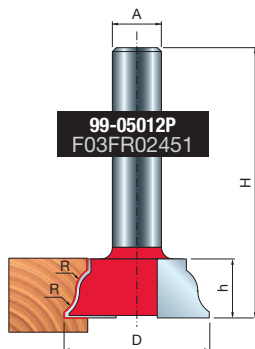
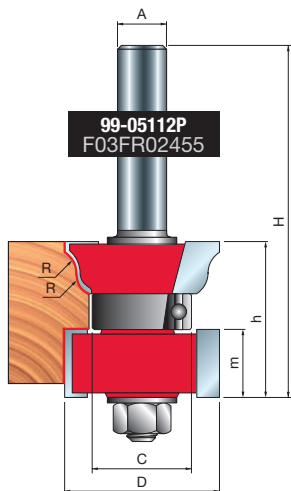

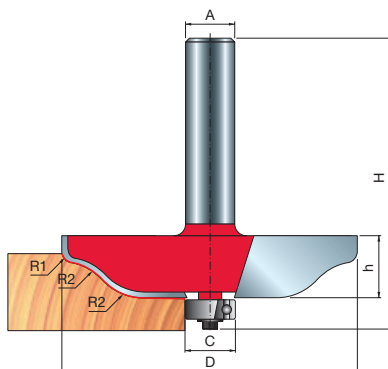

Fraises pour plate-bande 99-



Type A

| D | h | H | A | C | R1 | R2 | Z | tr/min max. | Code Freud | N° article | |
|------|----|------|----|------|------|----|---|-------------|------------------|------------------|------------|
| mm | mm | mm | mm | inch | mm | mm | | tr/min | | | |
| 76,2 | 16 | 64,7 | 12 | | 12,7 | 2 | 2 | 12.000 | 99-22112P | F03FR02458 | |
| 70 | 16 | 64,5 | | 1/2 | 12,7 | 14 | 3 | 4 | 12.000 | 99-51050P | F03FR02504 |
| 89 | 16 | 64,5 | | 1/2 | 12,7 | 20 | 4 | 4 | 10.000 | 99-52050P | F03FR02512 |

| | Pièces détachées | Dimensions mm | Code Freud | N° article |
|---|--------------------|--------------------|------------------|------------|
|  | Vis | M3 x 7,6 | 2607M 001 | F03F010000 |
|  | Roulement à billes | 12,7 x 4,98 x 4,76 | 3102M AB9 | F03F010007 |
|  | Rondelle | 12 x 1,1 x 4,8 | FX07M AB9 | F03F010159 |

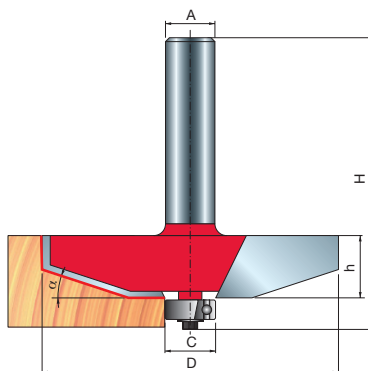

Type B

| D | h | H | A | C | α | Z | tr/min max. | Code Freud | N° article | |
|------|----|------|----|------|------|----|-------------|------------|------------------|------------|
| mm | mm | mm | mm | inch | mm | mm | tr/min | | | |
| 76,2 | 16 | 64,7 | 12 | | 12,7 | 2 | 2 | 12.000 | 99-22112P | F03FR02458 |
| 70 | 16 | 64,5 | | 1/2 | 12,7 | 14 | 4 | 12.000 | 99-51050P | F03FR02504 |
| 89 | 16 | 64,5 | | 1/2 | 12,7 | 20 | 4 | 10.000 | 99-52050P | F03FR02512 |

Pour les pièces de rechange, voir le tableau **Type A**.

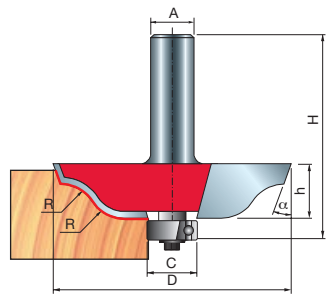

Type C

| D | h | H | A | C | α | R | Z | tr/min max. | Code Freud | N° article |
|----|----|------|------|------|----------|----|---|-------------|------------|------------|
| mm | mm | mm | inch | mm | | mm | | tr/min | | |
| 70 | 16 | 64,5 | 1/2 | 12,7 | 20° | 11 | 4 | 12.000 | 99-51350P | F03FR02507 |

Pour les pièces de rechange, voir le tableau **Type A**.

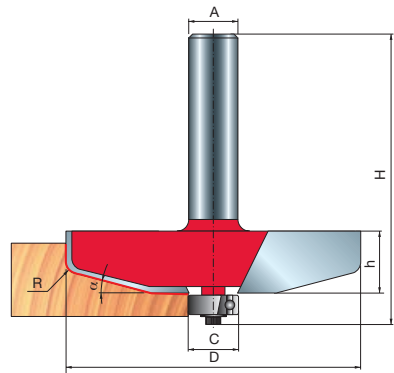

Type D

| D | h | H | A | C | α | R | Z | tr/min max. | Code Freud | N° article |
|------|----|----|------|------|----------|-----|---|-------------|------------|------------|
| mm | mm | mm | inch | mm | | mm | | tr/min | | |
| 76,2 | 16 | 60 | 12 | 12,7 | 15° | 4,8 | 2 | 12.000 | 99-22412P | F03FR02461 |

Pour les pièces de rechange, voir le tableau **Type A**.

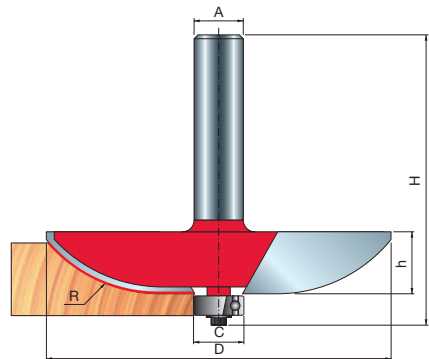

Type E

| D | h | H | A | C | R | Z | tr/min max. | Code Freud | N° article |
|----|----|------|-----|------|------|----|-------------|------------|------------|
| mm | mm | mm | mm | inch | mm | mm | tr/min | | |
| 89 | 16 | 64,7 | 12 | 12,7 | 38,1 | 2 | 10.000 | 99-22512P | F03FR02462 |
| 89 | 16 | 64,5 | 1/2 | 12,7 | 38 | 4 | 10.000 | 99-51850P | F03FR02510 |

Pour les pièces de rechange, voir le tableau **Type A**.

Fraises pour plate-bande avec tranchants arrière à feuilleur 99-



| D | h | H | A | α | R1 | R2 | Z | tr/min max. | Code Freud | N° article |
|----|----|----|----|----------|----|----|---|-------------|------------------|------------|
| mm | mm | mm | mm | | mm | mm | | tr/min | | |
| 89 | 25 | 75 | 12 | 15° | 6 | - | 2 | 14.000 | 99-56612P | F03FR02515 |
| 89 | 25 | 75 | 12 | 15° | 38 | 6 | 2 | 14.000 | 99-56912P | F03FR02523 |
| 89 | 25 | 75 | 12 | 15° | 30 | 6 | 2 | 14.000 | 99-57112P | F03FR02529 |

| | Pièces détachées | Dimensions mm | Code Freud | N° article |
|--|------------------|---------------|-------------------|------------|
| | Écrou hexagonal | 7,94 x 6,75 | 2610M BB9 | F03F010003 |
| | Bague de calage | 18 x 0,1 x 8 | AN01MP0019 | F03FC00392 |
| | Bague de calage | 18 x 0,2 x 8 | AN01MP0029 | F03FC00393 |
| | Bague de calage | 18 x 0,5 x 8 | AN01MP0059 | F03FC00395 |
| | Bague de calage | 18 x 1 x 8 | AN01MP0109 | F03FC00396 |
| | Bague de calage | 18 x 0,15 x 8 | AN01MPAA99 | F03FC00391 |

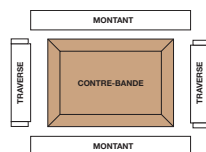
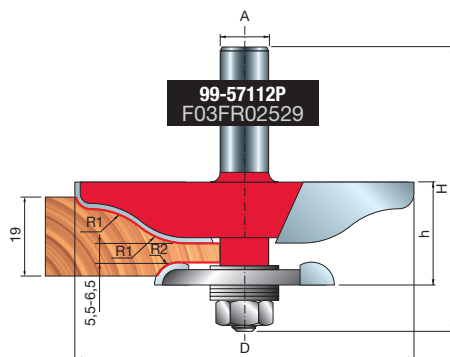
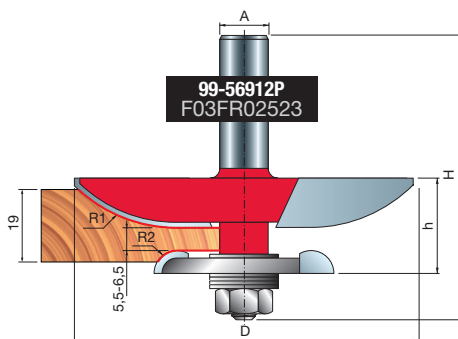
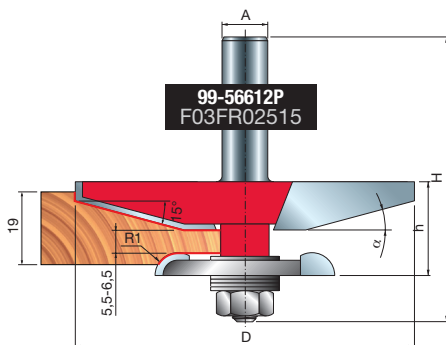

Fraises verticales pour plate-bande

99-

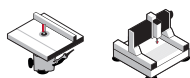

| D | h | H | A | α | R1 | R2 | Z | tr/min max. | Code Freud | N° article |
|------|------|------|----|----------|------|----|---|-------------|------------------|------------|
| mm | mm | mm | mm | | mm | mm | | tr/min | | |
| 31,8 | 41,5 | 79,5 | 12 | - | 2 | 16 | 2 | 16.000 | 99-32212P | F03FR02500 |
| 31,8 | 41,5 | 79,5 | 12 | 18° | - | - | 2 | 16.000 | 99-32312P | F03FR02501 |
| 31,8 | 41,5 | 79,5 | 12 | 15° | 4,8 | - | 2 | 16.000 | 99-32412P | F03FR02502 |
| 31,8 | 41,5 | 79,5 | 12 | - | 38,1 | - | 2 | 16.000 | 99-32512P | F03FR02503 |

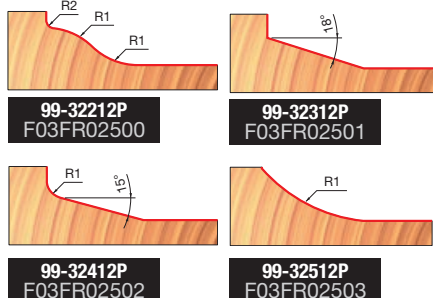
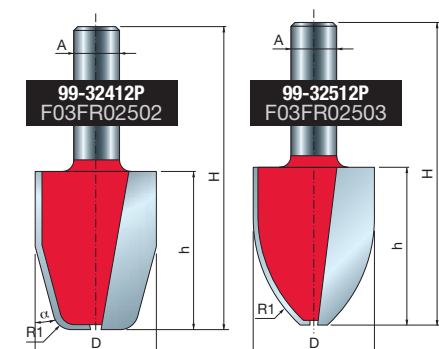
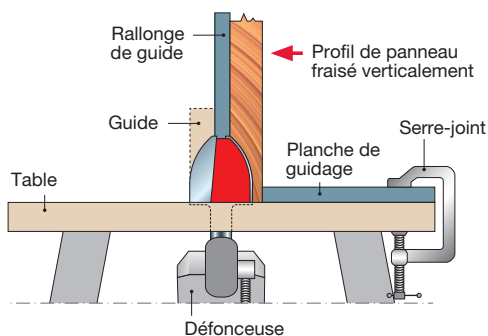
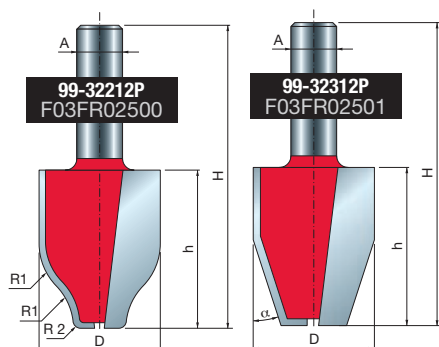



FRAISES À SURFACER

Fraises pour rainure en V 20- PI01

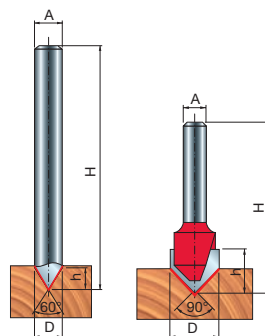
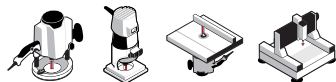

| D | h | H | A | α | Z | tr/min max. | Code Freud | N° article |
|-------|------|------|----|----------|---|-------------|-------------------|------------|
| mm | mm | mm | mm | inch | | tr/min | | |
| • 6 | 6 | 38,1 | 6 | 90° | 1 | 24.000 | 20-10006P | F03FR01617 |
| 9,5 | 10 | 44,4 | 6 | 90° | 2 | 24.000 | 20-10206P | F03FR01619 |
| 12,7 | 10 | 44,4 | 6 | 90° | 2 | 24.000 | 20-10406P | F03FR01622 |
| 12,7 | 12,7 | 49,2 | 6 | 60° | 2 | 24.000 | 20-15206P | F03FR01629 |
| 12,7 | 11 | 57,3 | 6 | 60° | 3 | 24.000 | 20-15406P | F03FR01632 |
| • 6 | 6 | 38,1 | 8 | 90° | 1 | 24.000 | 20-10008P | F03FR01618 |
| • 8 | 6 | 70 | 8 | 60° | 1 | 30.000 | PI01MD6083 | F03FR00382 |
| • 8 | 8 | 70 | 8 | 60° | 1 | 24.000 | 20-16008P | F03FR01634 |
| 9,5 | 10 | 44,4 | 8 | 90° | 2 | 24.000 | 20-10208P | F03FR01620 |
| 12,7 | 10 | 44,4 | 8 | 90° | 2 | 24.000 | 20-10408P | F03FR01623 |
| 12,7 | 12,7 | 50,8 | 8 | 60° | 2 | 24.000 | 20-15208P | F03FR01630 |
| 12,7 | 11 | 54 | 8 | 60° | 3 | 24.000 | 20-15408P | F03FR01633 |
| 31,75 | 16 | 51 | 8 | 90° | 2 | 24.000 | 20-91408P | F03FR02857 |

| D | h | H | A | α | Z | tr/min max. | Code Freud | N° article |
|-------|------|------|----|----------|---|-------------|------------------|------------|
| mm | mm | mm | mm | inch | | tr/min | | |
| 15,88 | 12,5 | 56,5 | 12 | | 2 | 24.000 | 20-10612P | F03FR01625 |
| 19,05 | 12,5 | 57,2 | 12 | | 2 | 24.000 | 20-10812P | F03FR01626 |
| 9,53 | 10 | 44,4 | | 1/4 | 2 | 24.000 | 20-10225P | F03FR01621 |
| 12,7 | 10 | 44,4 | | 1/4 | 2 | 24.000 | 20-10425P | F03FR01624 |
| 12,7 | 12,7 | 47,5 | | 1/4 | 2 | 24.000 | 20-15225P | F03FR01631 |
| 12,7 | 12,7 | 54,7 | | 1/2 | 2 | 24.000 | 20-10950P | F03FR01628 |

• Fraises en carbure massif

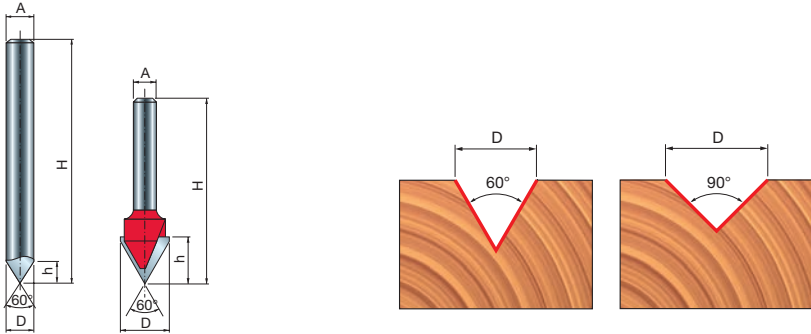

Fraises en carbure massif

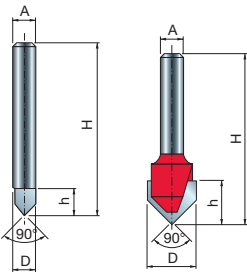

Fraises en carbure massif

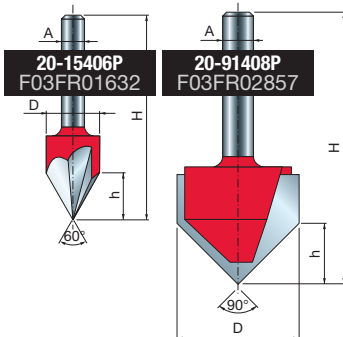

Fraises pour rainure en « V » pour le pliage de panneaux ACM 21-

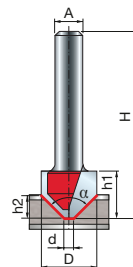
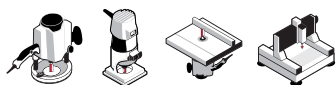

| D | h1 | h2 | H | A | C | α | Z | tr/min max. | Code Freud | N° article |
|-------|------|-----|------|-----|------|----------|---|-------------|------------------|------------|
| mm | mm | mm | mm | mm | inch | mm | | tr/min | | |
| 16 | 12,5 | 6,8 | 50,8 | 6 | 2,5 | 90° | 2 | 24.000 | 21-11206P | F03FR04018 |
| 19,05 | 12,5 | 6 | 50,8 | 6 | 2,5 | 108° | 2 | 24.000 | 21-14606P | F03FR04021 |
| 22,23 | 12,5 | 4,2 | 50,8 | 6 | 2,29 | 135° | 2 | 24.000 | 21-18206P | F03FR04024 |
| 16 | 12,5 | 6,8 | 50,8 | 8 | 2,5 | 90° | 2 | 24.000 | 21-11208P | F03FR04019 |
| 19,05 | 12,5 | 6 | 50,8 | 8 | 2,5 | 108° | 2 | 24.000 | 21-14608P | F03FR04022 |
| 22,23 | 12,5 | 4,2 | 50,8 | 8 | 2,29 | 135° | 2 | 24.000 | 21-18208P | F03FR04025 |
| 12,7 | 10,8 | 5,2 | 50,8 | 1/4 | 2,29 | 90° | 2 | 24.000 | 21-11025P | F03FR04017 |
| 16 | 12,7 | 6,8 | 50,8 | 1/4 | 2,5 | 90° | 2 | 24.000 | 21-11225P | F03FR04020 |
| 19,05 | 12,7 | 6 | 50,8 | 1/4 | 2,5 | 108° | 2 | 24.000 | 21-14625P | F03FR04023 |
| 22,23 | 12,7 | 4,2 | 50,8 | 1/4 | 2,29 | 135° | 2 | 24.000 | 21-18225P | F03FR04026 |

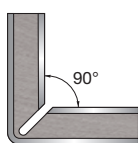

$\alpha = 90^\circ$

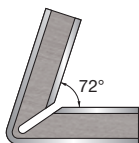

$\alpha = 108^\circ$

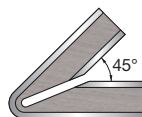

$\alpha = 135^\circ$

Fraises pour rainure rectangulaire pour le pliage de panneaux ACM 21-

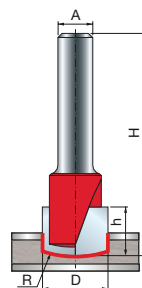
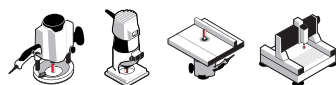

| D | h | H | A | R | Z | tr/min max. | Code Freud | N° article |
|-------|----|------|-----|------|----|-------------|------------------|------------|
| mm | mm | mm | mm | inch | mm | tr/min | | |
| 15,88 | 11 | 50 | 8 | 23,8 | 2 | 24.000 | 21-20008P | F03FR03967 |
| 15,88 | 11 | 50,8 | 1/4 | 23,8 | 2 | 24.000 | 21-20025P | F03FR03963 |

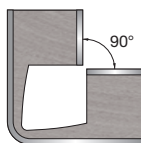

Fraises pour lettrage 20-

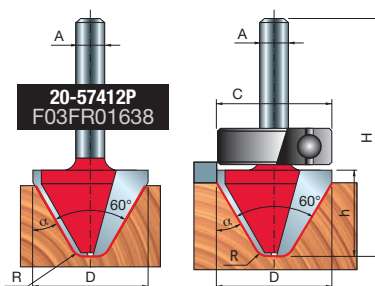
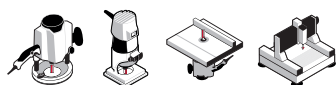

| D | h | H | A | C | R | α | Z | tr/min max. | Code Freud | N° article |
|-------|----|-------|----|----|----|----------|---|-------------|------------------|------------|
| mm | mm | mm | mm | mm | mm | | | tr/min | | |
| 25,4 | 19 | 51,05 | 6 | - | 3 | 60° | 2 | 24.000 | 20-17206P | F03FR01635 |
| 25,4 | 19 | 51,05 | 8 | - | 3 | 60° | 2 | 24.000 | 20-17208P | F03FR01636 |
| 28,57 | 19 | 57 | 12 | - | 3 | 60° | 2 | 18.000 | 20-17412P | F03FR01637 |
| 28 | 19 | 67,15 | 12 | 28 | 3 | 60° | 2 | 18.000 | 20-57412P | F03FR01638 |

Fraises à bout arrondi 18-

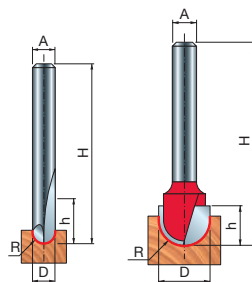
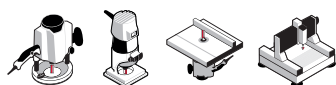

| D | h | H | A | R | Z | tr/min max. | Code Freud | N° article |
|---------|------|------|----|------|------|-------------|------------|-----------------------------|
| mm | mm | mm | mm | inch | mm | tr/min | | |
| • 3,2 | 9,5 | 50,5 | 6 | | 1,6 | 2 | 24.000 | 18-10006P F03FR01581 |
| • 4,8 | 9,5 | 50,5 | 6 | | 2,4 | 2 | 24.000 | 18-10206P F03FR01584 |
| • 6 | 12,7 | 50,8 | 6 | | 3 | 2 | 24.000 | 18-10406P F03FR01587 |
| • 9,52 | 9 | 46 | 6 | | 4,8 | 2 | 24.000 | 18-10606P F03FR01590 |
| • 12 | 9 | 46 | 6 | | 6 | 2 | 24.000 | 18-10806P F03FR01593 |
| • 15,88 | 11 | 50,8 | 6 | | 8 | 2 | 24.000 | 18-11006P F03FR01596 |
| • 19,05 | 11 | 50,8 | 6 | | 9,5 | 2 | 24.000 | 18-11206P F03FR01599 |
| • 3,2 | 9,5 | 50,5 | 8 | | 1,6 | 2 | 24.000 | 18-10008P F03FR01582 |
| • 4,8 | 9,5 | 50,5 | 8 | | 2,4 | 2 | 24.000 | 18-10208P F03FR01585 |
| • 6 | 12,7 | 50,8 | 8 | | 3 | 2 | 24.000 | 18-10408P F03FR01588 |
| • 9,52 | 9 | 46 | 8 | | 4,8 | 2 | 24.000 | 18-10608P F03FR01591 |
| • 12 | 9 | 46 | 8 | | 6 | 2 | 24.000 | 18-10808P F03FR01594 |
| • 15,88 | 11 | 50,8 | 8 | | 8 | 2 | 24.000 | 18-11008P F03FR01597 |
| • 19,05 | 11 | 50,8 | 8 | | 9,5 | 2 | 24.000 | 18-11208P F03FR01600 |
| • 6 | 9,5 | 57 | 12 | | 3 | 2 | 24.000 | 18-11412P F03FR01602 |
| • 12,7 | 31,7 | 71,5 | 12 | | 6,35 | 2 | 24.000 | 18-11612P F03FR01604 |
| • 19,05 | 31,7 | 73 | 12 | | 9,5 | 2 | 24.000 | 18-12212P F03FR01606 |
| • 25,4 | 31,7 | 73 | 12 | | 12,7 | 2 | 24.000 | 18-12612P F03FR01608 |
| • 3,18 | 9,5 | 50,5 | | 1/4 | 1,59 | 2 | 24.000 | 18-10025P F03FR01583 |

| D | h | H | A | R | Z | tr/min max. | Code Freud | N° article |
|-------|------|------|-----|------|----|-------------|------------------|------------|
| mm | mm | mm | mm | inch | mm | tr/min | | |
| 4,76 | 6,4 | 50,5 | 1/4 | 2,38 | 2 | 24.000 | 18-10225P | F03FR01586 |
| 6,35 | 12,7 | 50,5 | 1/4 | 3,18 | 2 | 24.000 | 18-10425P | F03FR01589 |
| 9,52 | 9 | 45 | 1/4 | 4,77 | 2 | 24.000 | 18-10625P | F03FR01592 |
| 12,7 | 9 | 45,5 | 1/4 | 6,35 | 2 | 24.000 | 18-10825P | F03FR01595 |
| 15,88 | 11 | 48 | 1/4 | 7,94 | 2 | 24.000 | 18-11025P | F03FR01598 |
| 19,05 | 11 | 48 | 1/4 | 9,53 | 2 | 24.000 | 18-11225P | F03FR01601 |
| 6,35 | 12,7 | 61 | 1/2 | 3,18 | 2 | 24.000 | 18-11450P | F03FR01603 |
| 12,7 | 31,7 | 72,7 | 1/2 | 6,35 | 2 | 24.000 | 18-11650P | F03FR01605 |
| 19 | 31,7 | 73 | 1/2 | 9,5 | 2 | 24.000 | 18-12250P | F03FR01607 |

- Fraises en carbure massif

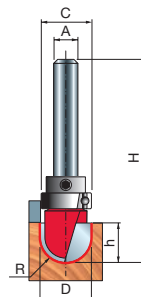

Fraises avec roulement à billes
(ne conviennent pas pour les machines CNC)

| D | h | H | A | R | C | Z | tr/min max. | Code Freud | N° article |
|-------|------|------|----|-----|-------|---|-------------|------------------|------------|
| mm | mm | mm | mm | mm | mm | | tr/min | | |
| 15,88 | 11 | 59,5 | 6 | 8 | 15,8 | 2 | 24.000 | 18-51006P | F03FR01609 |
| 19,05 | 11,1 | 59,5 | 6 | 9,5 | 19 | 2 | 24.000 | 18-51206P | F03FR01611 |
| 15,88 | 11 | 59,5 | 8 | 8 | 15,8 | 2 | 24.000 | 18-51008P | F03FR01610 |
| 19,05 | 11 | 59,5 | 8 | 9,5 | 19,05 | 2 | 24.000 | 18-51208P | F03FR01612 |

Fraises pour sculptures
19- 99-

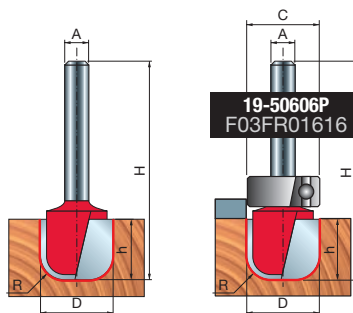
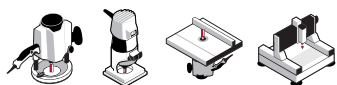

| D | h | H | A | R | C | Z | tr/min max. | Code Freud | N° article |
|-------|------|------|----|------|----|---|-------------|------------------|------------|
| mm | mm | mm | mm | mm | mm | | tr/min | | |
| 19 | 15,9 | 64,1 | 6 | 6,35 | 19 | 2 | 24.000 | 19-50606P | F03FR01616 |
| 19,05 | 15,9 | 47,5 | 6 | 6,35 | - | 2 | 24.000 | 19-10606P | F03FR01613 |
| 19,05 | 15,9 | 47,5 | 8 | 6,35 | - | 2 | 24.000 | 19-10608P | F03FR01614 |
| 19,05 | 15,9 | 67 | 12 | 6,35 | - | 2 | 24.000 | 19-12612P | F03FR01615 |
| 31,75 | 15,8 | 53 | 12 | 6,35 | - | 2 | 18.000 | 99-02612P | F03FR02420 |

Fraises pour rainures quart de rond 39-

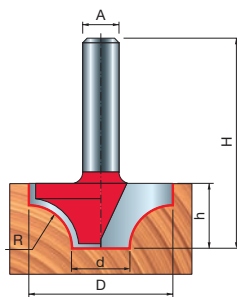
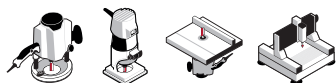

| D | h | H | A | R | d | Z | tr/min max. | Code Freud | N° article |
|-------|------|------|----|------|------|---|-------------|-------------------|------------|
| mm | mm | mm | mm | mm | mm | | tr/min | | |
| 12,7 | 8 | 40 | 6 | 3,2 | 6,35 | 2 | 24.000 | 39-20206P | F03FR01871 |
| 24,7 | 12,7 | 44,7 | 8 | 6 | 12,7 | 2 | 24.000 | 39-20908P | F03FR01873 |
| 31,75 | 14,3 | 46,3 | 8 | 9,53 | 12,7 | 2 | 18.000 | 39-20808P | F03FR01872 |
| 63,5 | 33,3 | 71,3 | 12 | 25,4 | 12,7 | 2 | 12.000 | 39-23812P* | F03FR01874 |

* Ne convient pas pour les défonceuses portatives.

Fraises pour arrondi convexe et double arrondi concave 39-

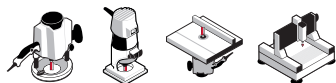

| D | h | H | A | C | R1 | R2 | R3 | Z | tr/min max. | Code Freud | N° article |
|------|----|------|----|------|-----|-----|-----|---|-------------|------------------|------------|
| mm | mm | mm | mm | mm | mm | mm | mm | | tr/min | | |
| 39,6 | 13 | 45 | 6 | - | 7,9 | 4,2 | 3,4 | 2 | 16.000 | 39-60006P | F03FR01896 |
| 39,6 | 13 | 60,1 | 6 | 39,6 | 7,9 | 4,2 | 3,4 | 2 | 16.000 | 39-65006P | F03FR01898 |
| 39,6 | 13 | 45 | 8 | - | 7,9 | 4,2 | 3,4 | 2 | 16.000 | 39-60008P | F03FR01897 |
| 39,6 | 13 | 60,1 | 8 | 39,6 | 7,9 | 4,2 | 3,4 | 2 | 16.000 | 39-65008P | F03FR01899 |

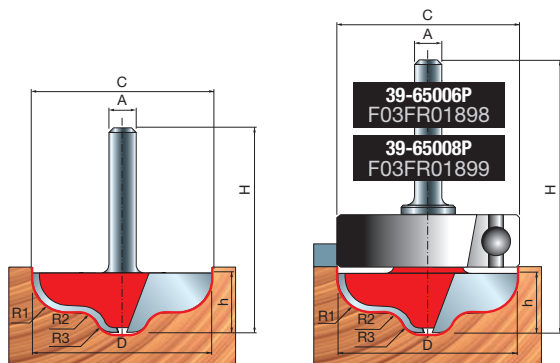

Fraises avec roulement supérieur pour double arrondi concave 39-

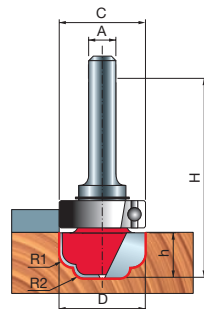

| D | h | H | A | C | R1 | R2 | Z | tr/min max. | Code Freud | N° article |
|----|-----|----|----|----|-----|-----|---|-------------|------------------|------------|
| mm | mm | mm | mm | mm | mm | mm | | tr/min | | |
| 19 | 9,6 | 53 | 6 | 19 | 3,2 | 2,4 | 2 | 24.000 | 39-51206P | F03FR01887 |

Fraises pour arrondi concave / convexe 39-

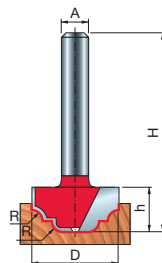
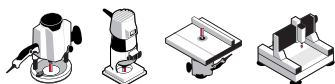

| D | h | H | A | R | Z | tr/min max. | Code Freud | N° article | |
|-------|------|------|----|------|------|-------------|------------|------------------|------------|
| mm | mm | mm | mm | inch | mm | tr/min | | | |
| 19,05 | 9,8 | 41,8 | 6 | | 2,38 | 2 | 24.000 | 39-10006P | F03FR01856 |
| 25,4 | 12,7 | 44,7 | 6 | | 3,18 | 2 | 24.000 | 39-10206P | F03FR01860 |
| 19,05 | 9,8 | 41,8 | 8 | | 2,38 | 2 | 24.000 | 39-10008P | F03FR01857 |
| 19 | 12,7 | 44,7 | 8 | | 4 | 2 | 24.000 | 39-10108P | F03FR01859 |
| 25,4 | 12,7 | 44,7 | 8 | | 3,18 | 2 | 24.000 | 39-10208P | F03FR01861 |
| 31,75 | 12,7 | 44,7 | 8 | | 4 | 2 | 18.000 | 39-11408P | F03FR01863 |
| 31,75 | 12,7 | 50,7 | 12 | | 4 | 2 | 18.000 | 39-11412P | F03FR01864 |
| 19,05 | 9,8 | 41,8 | | 1/4 | 2,38 | 2 | 24.000 | 39-10025P | F03FR01858 |
| 25,4 | 12,7 | 44,7 | | 1/4 | 3,18 | 2 | 24.000 | 39-10225P | F03FR01862 |

Fraises pour rainures décoratives classiques

39-

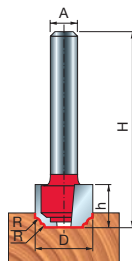
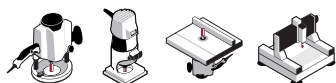

| D | h | H | A | R | Z | tr/min max. | Code Freud | N° article | |
|-------|-----|------|----|------|------|-------------|------------|------------------|------------|
| mm | mm | mm | mm | inch | mm | tr/min | | | |
| 12,7 | 9,5 | 41,2 | 6 | | 1,2 | 2 | 24.000 | 39-30206P | F03FR01878 |
| 15,88 | 9,5 | 41,2 | 6 | | 2,38 | 2 | 24.000 | 39-30406P | F03FR01881 |
| 22,22 | 12 | 43,7 | 6 | | 3,18 | 2 | 24.000 | 39-30606P | F03FR01884 |
| 12,7 | 9,5 | 41,2 | 8 | | 1,2 | 2 | 24.000 | 39-30208P | F03FR01879 |
| 15,88 | 9,5 | 41,2 | 8 | | 2,38 | 2 | 24.000 | 39-30408P | F03FR01882 |
| 22,22 | 12 | 43,7 | 8 | | 3,2 | 2 | 24.000 | 39-30608P | F03FR01885 |
| 12,7 | 9,5 | 41,2 | | 1/4 | 1,2 | 2 | 24.000 | 39-30225P | F03FR01880 |
| 15,88 | 9,5 | 41,2 | | 1/4 | 2,38 | 2 | 24.000 | 39-30425P | F03FR01883 |
| 22,22 | 12 | 43,7 | | 1/4 | 3,18 | 2 | 24.000 | 39-30625P | F03FR01886 |

Fraises pour rainures en doucine

39-

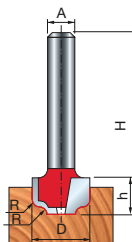
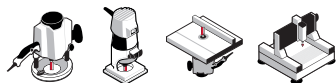

| D | h | H | A | R | Z | tr/min max. | Code Freud | N° article | |
|-------|-------|------|----|------|------|-------------|------------|------------------|------------|
| mm | mm | mm | mm | inch | mm | tr/min | | | |
| 12,7 | 8 | 40 | 6 | | 1,59 | 2 | 24.000 | 39-15206P | F03FR01865 |
| 19,05 | 12,7 | 44,7 | 6 | | 6,35 | 2 | 24.000 | 39-24006P | F03FR01875 |
| 22,23 | 10,36 | 42,4 | 6 | | 3,18 | 2 | 24.000 | 39-15406P | F03FR01868 |
| 12,7 | 8 | 40 | 8 | | 1,6 | 2 | 24.000 | 39-15208P | F03FR01866 |
| 19,05 | 12,7 | 44,7 | 8 | | 6,4 | 2 | 24.000 | 39-24008P | F03FR01876 |
| 22,23 | 10,36 | 42,4 | 8 | | 3,2 | 2 | 24.000 | 39-15408P | F03FR01869 |
| 19,05 | 12,7 | 50,7 | 12 | | 6,4 | 2 | 24.000 | 39-24012P | F03FR01877 |
| 12,7 | 8 | 40 | | 1/4 | 1,59 | 2 | 24.000 | 39-15225P | F03FR01867 |
| 22,23 | 10,4 | 42,4 | | 1/4 | 3,18 | 2 | 24.000 | 39-15425P | F03FR01870 |

Fraises avec roulement supérieur pour arrondi concave / convexe 39-

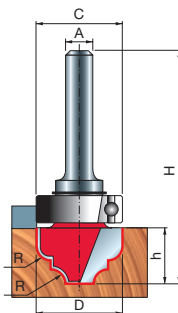

| D | h | H | A | C | R | Z | tr/min max. | Code Freud | N° article | |
|----|------|------|-----|------|----|------|-------------|------------|------------------|------------|
| mm | mm | mm | mm | inch | mm | mm | tr/min | | | |
| 19 | 12,7 | 55,5 | 6 | | 19 | 3,18 | 2 | 24.000 | 39-53206P | F03FR01892 |
| 28 | 14 | 58,1 | 8 | | 28 | 3,18 | 2 | 18.000 | 39-53808P | F03FR01894 |
| 28 | 14 | 64,1 | 12 | | 28 | 3,18 | 2 | 18.000 | 39-53812P | F03FR01895 |
| 19 | 12,7 | 55,5 | 1/4 | | 19 | 3,18 | 2 | 24.000 | 39-53225P | F03FR01893 |

Fraises avec roulement supérieur pour rainure en doucine 39-

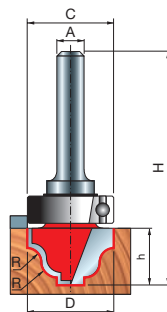

| D | h | H | A | C | R | Z | tr/min max. | Code Freud | N° article | |
|----|------|------|-----|------|----|------|-------------|------------|------------------|------------|
| mm | mm | mm | mm | inch | mm | mm | tr/min | | | |
| 19 | 12,5 | 55,5 | 6 | | 19 | 3,18 | 2 | 24.000 | 39-52206P | F03FR01888 |
| 28 | 14,4 | 58,1 | 8 | | 28 | 4 | 2 | 18.000 | 39-52808P | F03FR01890 |
| 28 | 14,4 | 64,1 | 12 | | 28 | 4 | 2 | 18.000 | 39-52812P | F03FR01891 |
| 19 | 12,5 | 55,5 | 1/4 | | 19 | 3,18 | 2 | 24.000 | 39-52225P | F03FR01889 |



COFFRETS

Coffrets

88- 90- 91- 92-

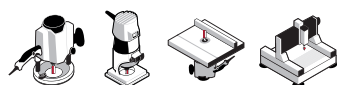

| | A | Code Freud | N° article |
|----------------------------------|----|------------------|------------|
| | mm | | |
| Coffret de base 4 fraises | 6 | 88-10606P | F03FR02255 |
| Coffret de base de 6 fraises | 8 | 91-10408P | F03FR02293 |
| Coffret de base de 6 fraises | 12 | 91-10412P | F03FR02294 |
| Coffret intermédiaire 9 fraises | 6 | 88-10206P | F03FR02250 |
| Super coffret 13 fraises | 8 | 91-10008P | F03FR02275 |
| Super coffret 13 fraises | 12 | 91-10012P | F03FR02277 |
| Coffret d'expert 15 fraises | 6 | 90-10006P | F03FR02256 |
| Coffret professionnel 26 fraises | 6 | 92-10006P | F03FR02308 |

Coffret de 3 fraises pour portes d'armoires 97-

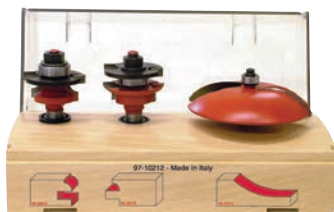

| | A | Code Freud | N° article |
|---|----|------------|------------|
| | mm | | |
| Fraise pour plate-bande + fraises de profils et contre-profils assortis | 12 | 97-10212P | F03FR02382 |

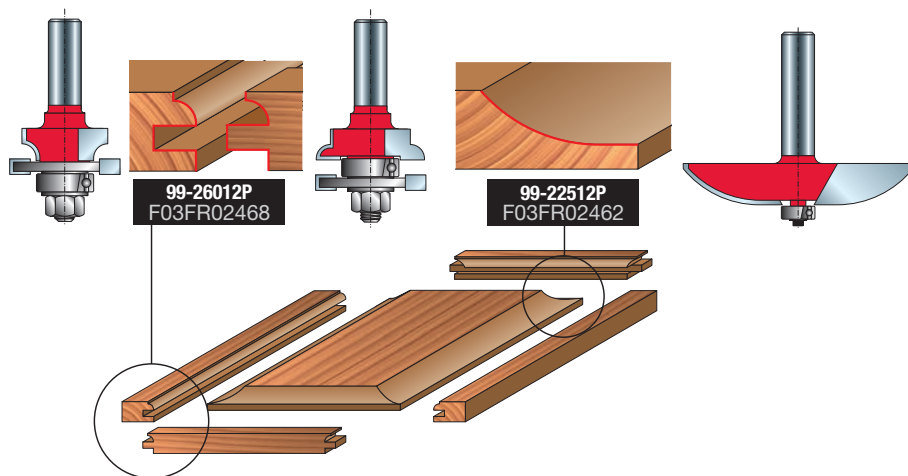

| | A | Code Freud | N° article |
|---|----|------------|------------|
| | mm | | |
| Fraise pour plate-bande + fraises de profils et contre-profils assortis | 12 | 97-10412P | F03FR02396 |

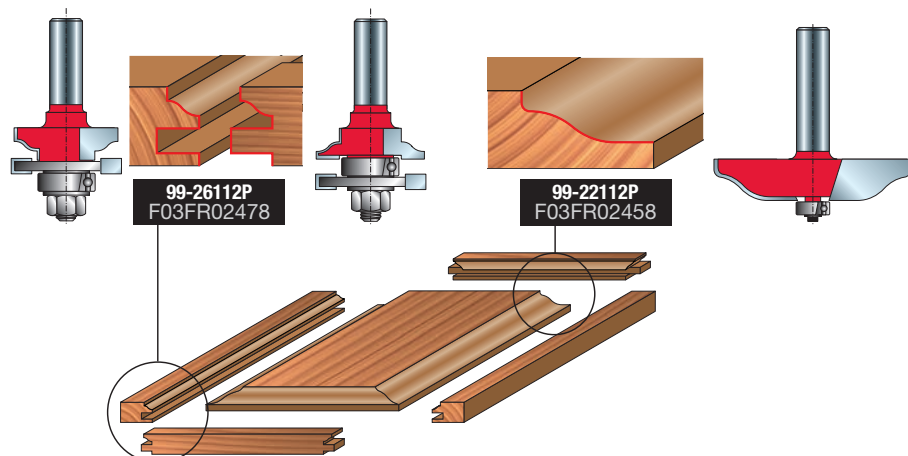

Coffret de 4 fraises pour portes d'armoires 95-

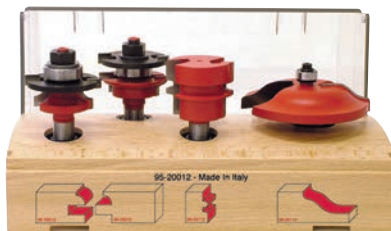

| | A | Code Freud | N° article |
|--|----|------------|------------|
| | mm | | |
| Fraise pour plate-bande + fraises de profils et contre-profils assortis + fraise pour joint collé réversible | 12 | 95-20012P | F03FR02368 |

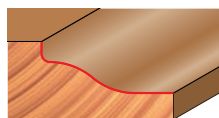
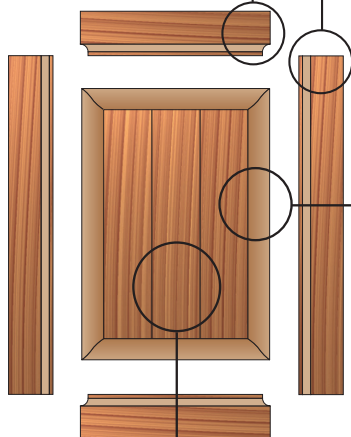

99-22112P
F03FR02458

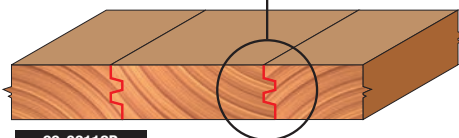
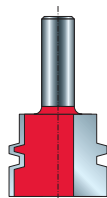
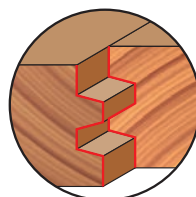
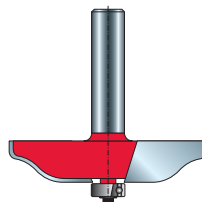

99-03112P
F03FR02422

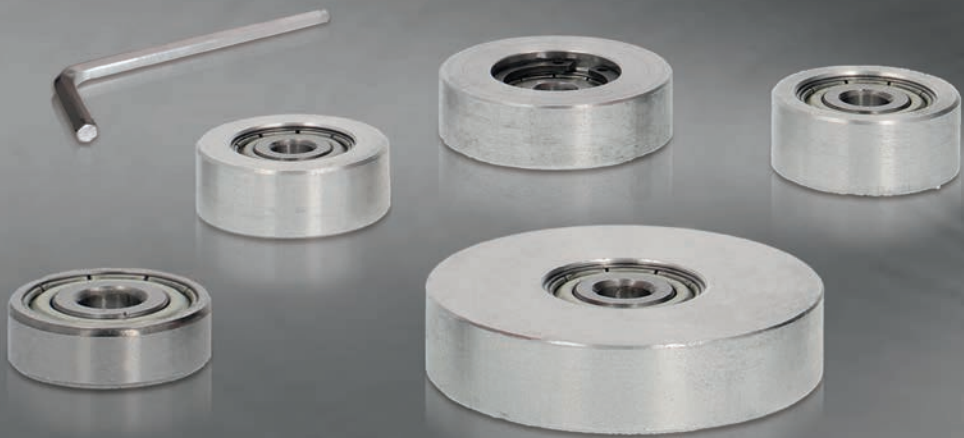

ACCESSOIRES

Bagues de réduction 3105M

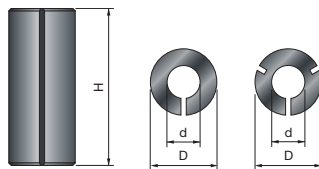

| D | H | d | Code Freud | N° article |
|------|----|------|-------------------|------------|
| mm | mm | mm | | |
| 8 | 25 | 6 | 3105MVY250 | F03FA10588 |
| 8 | 25 | 6,35 | 3105MVX250 | F03FA10587 |
| 9,5 | 25 | 6 | 3105MUY250 | F03FA10586 |
| 9,5 | 25 | 6,35 | 3105MUX250 | F03FA10585 |
| 9,5 | 25 | 8 | 3105MUV250 | F03FA10584 |
| 10 | 25 | 8 | 3105MTV250 | F03FA10582 |
| 12 | 25 | 6 | 3105MSY250 | F03FA10581 |
| 12 | 25 | 8 | 3105MSV250 | F03FA10580 |
| 12 | 25 | 10 | 3105MST250 | F03FA10579 |
| 12,7 | 25 | 6 | 3105MRY250 | F03FA10578 |
| 12,7 | 25 | 6,35 | 3105MRX250 | F03FA10577 |
| 12,7 | 25 | 8 | 3105MRV250 | F03FA10576 |
| 12,7 | 25 | 9,53 | 3105MRU250 | F03FA10575 |
| 16 | 25 | 13 | 3105MOQ250 | F03FA10574 |

Roulements à billes 3102M

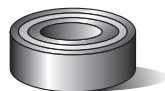
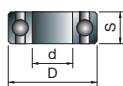

| D | S | d | Code Freud | N° article |
|-------|------|------|------------------|------------|
| mm | mm | mm | | |
| 9,53 | 3,2 | 4,76 | 3102M AA9 | F03F010006 |
| 12 | 4 | 6,05 | 3102M BB9 | F03FA10568 |
| 12,7 | 4,98 | 4,76 | 3102M AB9 | F03F010007 |
| 13 | 5 | 4 | 3102M CD9 | F03FA14096 |
| 13 | 5 | 6 | 3102M AP9 | F03FA10558 |
| 14 | 4 | 8,05 | 3102M BC9 | F03FA10569 |
| 15 | 5 | 6 | 3102M AQ9 | F03FA10559 |
| 15,88 | 4,98 | 4,76 | 3102M AJ9 | F03F010014 |
| 16 | 5 | 5 | 3102M CC9 | F03FA14095 |
| 16 | 5 | 8 | 3102M AS9 | F03FA10561 |
| 19 | 6 | 6 | 3102M CA9 | F03FA14097 |
| 19 | 7 | 10 | 3102M AG9 | F03F010012 |
| 19,05 | 3,97 | 12,7 | 3102M CB9 | F03FA14098 |
| 19,05 | 6,35 | 12,7 | 3102M AV9 | F03F012286 |
| 22 | 7 | 8 | 3102M AC9 | F03F010008 |
| 28 | 8 | 12 | 3102M AH9 | F03F010013 |
| 32 | 9 | 15 | 3102M AN9 | F03F010016 |
| 35 | 11 | 15 | 3102M AI9 | F03F012285 |

Guides à roulement à billes RB62M

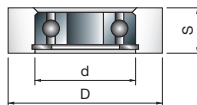

| D | S | d | Code Freud | N° article |
|-------|------|------|-------------------|------------|
| mm | mm | mm | | |
| 19,05 | 8 | 4,76 | RB62M 1509 | F03F011422 |
| 22,22 | 8 | 4,76 | RB62M 1529 | F03F011423 |
| 26 | 10 | 8 | RB62M 1249 | F03F011417 |
| 28,58 | 8 | 4,76 | RB62M 1549 | F03F011424 |
| 30 | 10 | 8 | RB62M 1289 | F03F011418 |
| 34 | 10 | 8 | RB62ME DA9 | F03FR01146 |
| 34,92 | 8 | 4,76 | RB62M 1569 | F03F011425 |
| 39,6 | 11,2 | 12 | RB62ME FB9 | F03FR01147 |

Guides coniques à roulement à billes 2103MC

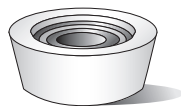
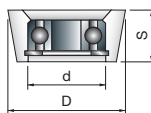

| D | S | d | α | Code Freud | N° article |
|-------|------|------|----------|-------------------|------------|
| mm | mm | mm | | | |
| 19,05 | 6,35 | 4,8 | 10° | 3103MC HB9 | F03F010019 |
| 22,2 | 9 | 12,7 | 15° | 3103MC HC9 | F03FR01724 |

CONSEILS D'UTILISATION ET CONSIGNES DE SÉCURITÉ

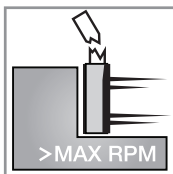

Ne pas dépasser la vitesse de rotation maximale indiquée sur l'outil. Une vitesse de rotation ou vitesse d'avance trop élevée ou une trop grande profondeur de coupe peut causer la casse de l'outil.

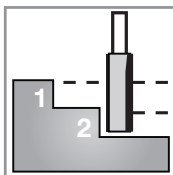

Pour retirer de grandes quantités de matière, effectuer plusieurs passes ou utiliser une vitesse de rotation et d'avance adaptées à la profondeur de coupe.

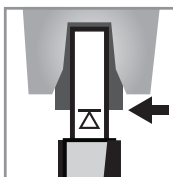

Respecter la profondeur d'insertion minimale indiquée sur la queue par un marquage.



Maintenir fermement la pièce à travailler sur l'établi.

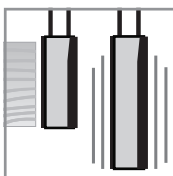

Toujours choisir des fraises avec des dimensions adaptées au travail à effectuer. Une fraise courte vibrera moins qu'une fraise longue de même diamètre.

CONSEILS D'UTILISATION ET CONSIGNES DE SÉCURITÉ

Règles à observer pour le sens de l'avance

Fraisage avec outils portatifs

Pour fraiser à l'intérieur d'une forme, déplacer la défonceuse dans le sens horaire.

Pour fraiser autour d'une forme, déplacer la défonceuse dans le sens anti-horaire.

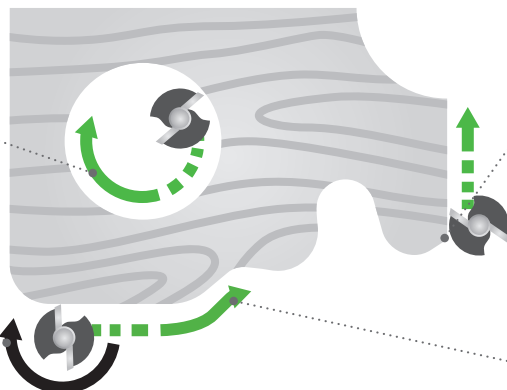

Pour réduire l'usure aux coins, débiter le fraisage perpendiculairement à la veine.

Déplacer la défonceuse dans le sens opposé au sens de rotation de la fraise.

Fraisage sur table

Pour le fraisage sur table, faire avancer la pièce dans le sens opposé au sens de rotation de la fraise.



Dépannage

| Problème | Réduire ▼ | Augmenter ▲ |
|--------------------|--|--|
| Marques de brûlure | Vitesse de rotation | Vitesse d'avance |
| Éclats | Vitesse d'avance | Vitesse de rotation |
| Vibrations | Vitesse de rotation Profondeur de coupe | Profondeur d'insertion de la fraise dans la pince de serrage Fixation de la pièce |
| Casse de la fraise | Vitesse d'avance Profondeur de coupe | Diamètre de queue |

Precisely the best

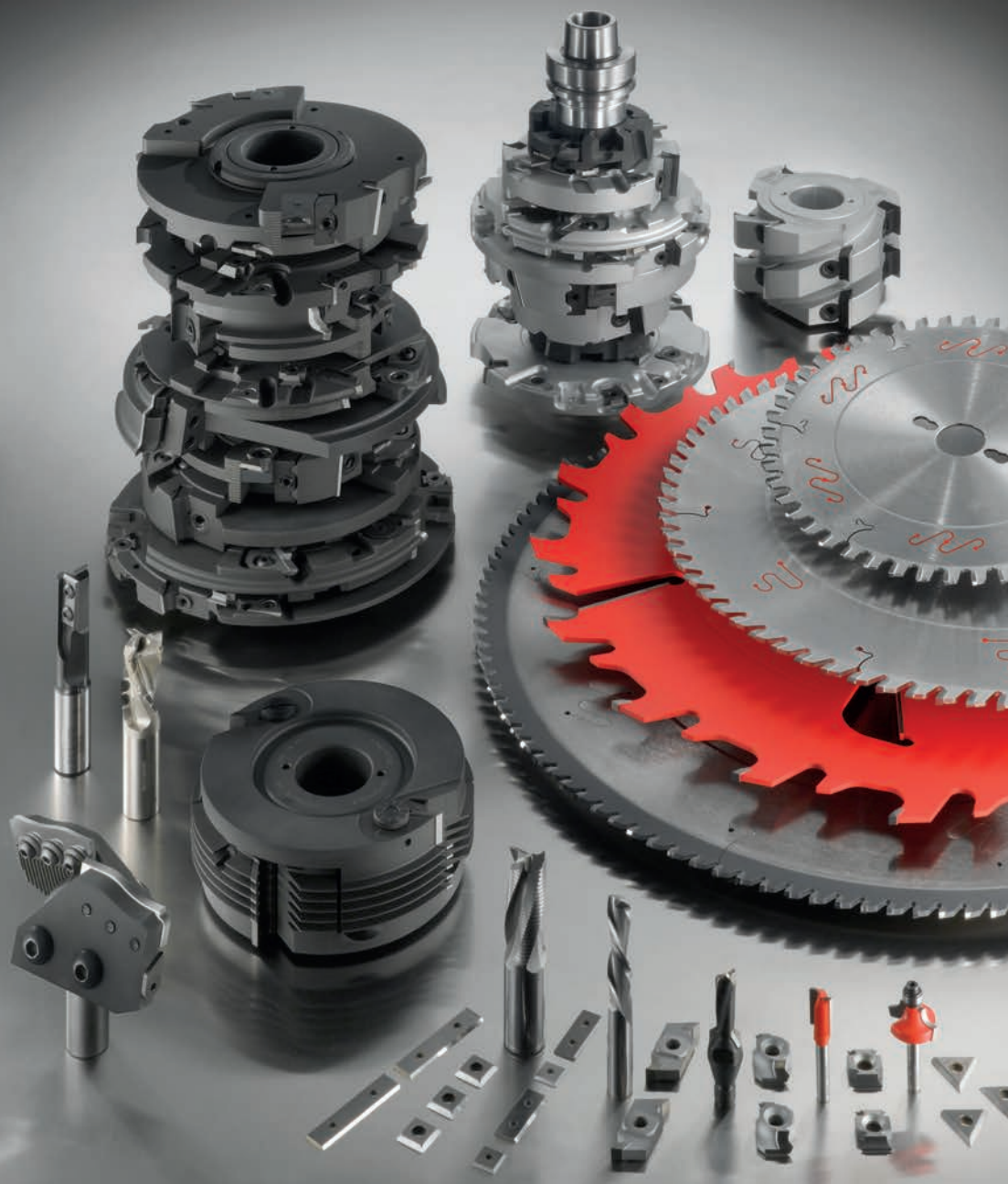



Freud - Leader dans la fabrication d'outils industriels depuis 1962

Freud est le leader mondial de l'industrie des outils de coupe et le plus grand fabricant de lames de scie circulaire haut de gamme. Depuis 1962, Freud conçoit et produit une vaste gamme de lames de scie circulaire, de porte-outils et fraises brasées, d'outils de perçage, de fraisage et d'outils CNC de qualité supérieure ainsi que des plaquettes et accessoires.

Les technologies et solutions Freud La perfection au service de vos besoins

Les outils de coupe haut de gamme Freud sont dotés de caractéristiques uniques et innovantes. L'entreprise contrôle l'ensemble du processus de fabrication des outils avec un suivi rigoureux de la qualité de ses produits dans ses usines en Italie. Les investissements continus réalisés par Freud dans la recherche et le développement, sa grande compétence en ingénierie et les technologies de pointe mises en œuvre permettent de fabriquer des produits innovants, d'une extrême précision et très grande durée de vie, toujours parfaitement adaptés aux besoins de chaque application.



Supériorité technologique Production en interne de carbures

Leader dans la fabrication de carbures depuis 1980 : Freud est fier d'être le seul fabricant à assurer entièrement en interne la production et le frittage de ses carbures, pour proposer des outils de coupe de qualité supérieure. Le TiCo Freud, un carbure à formulation spéciale à base de titane et de cobalt, garantit une précision maximale et permet d'obtenir des arêtes de coupe au tranchant très résistant. La capacité de Freud à élaborer des formulations pour les applications standard et spécifiques lui permet d'optimiser les performances des outils.

Réseau de distribution mondial Des services aux quatre coins du globe

Adepte du « penser globalement, agir localement », l'entreprise a développé un vaste réseau de filiales et partenaires dans plus de 90 pays. Ceci afin de proposer un service complet à nos clients partout dans le monde.



freud

Freud France

32 avenue Michelet
B.P. 170
93404 Saint Ouen Cedex
France

www.freudtools.fr



MKFRM 237 - F03FA23940 Printed in Italy - Juillet 2023 - Rev. 0