





freud

**Precisely
the best**

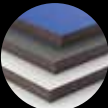

LSBX NeXt Generation
Prémium lapszabász körfűrészek

A LEGNAGYOBB KÖRFŰRÉSZ VÁLASZTÉK LAPSZABÁSZ GÉPEKRE

FORGÁCSLAP & MDF		● ● ●
LAMINÁLT FORGÁCSLAP & MDF		● ● ●
HPL		● ●
PLEXIÜVEG		● ●

Teljesítőképesség jelmagyarázata

● ● ● Kimagasló ● ● Nagy ● Jó

AUTOMATA LAPSZABÁSZ GÉPEKHEZ



SZÉLES ÁTMÉRŐTARTOMÁNYBAN KAPHATÓ

250 mm-től

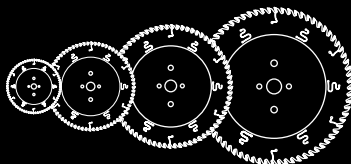

720 mm-ig



Alkalmas több mint

130 lapszabász géphez a legnépszerűbb márkákból

AES ANTHON AYZA MIZRAK

BIESSE FIMAL FELDER MAYER

GABBIANI GIBEN HOLZER

HOLZMA HOMAG NANXING

NIMAK PANHANS SCHEER KOCH

SCHELLING SCM SCM-GABBIANI

TÖRK MAKINE TURANLAR

MIÉRT A FREUD LSBX PONTOSAN A LEGJOBB LAPSZABÁSZATRA



Kiváló korrózióállóság és súrlódáscsökkentés
Silver I.C.E. bevonat.



Megnövelt él(et)tartam akár 25 újraélezésig
Szupersarkított fog kialakítás.

Kivételes vágási felületminőség
Megnövelt test stabilitás.

onot
nyü és korrózióvédő
hőmérsékletének
sára munkavégzéskor.
tulajdonsága fokozza
képpen csökkenti a
és megnöveli a fűrész



Rezgéscsökkentő rések

- A Freud innovatív technológiájával lézervágott rések az alaptesten.
- Termoplasztikus poliuretán töltéssel is kapható, amely

jelentősen csökkenti a rezgéseket és minimalizálja a zajkeltést.

JELÖLÉSEK ÉS RÖVIDÍTÉSEK MAGYARÁZATA

Útmutató a terméktáblázatokhoz

D	Külső átmérő (mm)	B	Vágás szélesség (mm)	B-B1	Állítható vágás-szélesség (mm)	b	Test vastagság (mm)
d	Furat (mm)	Z	Középfuratátmérő	α	Fogak száma (°)	β	Homlok-szög (°)

 Hát-szög

Optimalizált foggeometria

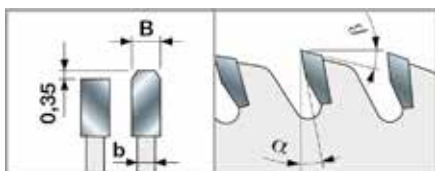

Az LSBX sorozat ideális választást képviseli ipari lapszabászathoz. A fűrésztrácsák alkalmasak laminált forgácslap és MDF panelekhez. Jó felületminőség HPL és akril panelek vágásánál is.

Útmutató az illesztőfuratokhoz

Példa

Illesztőfuratok	Freud kód	Cikksz.
● 2/10/60 + ● 2/13/94	példa	példa

● Középpontok távolsága
● Illesztőfura iátmérő
● Illesztőfuratok száma

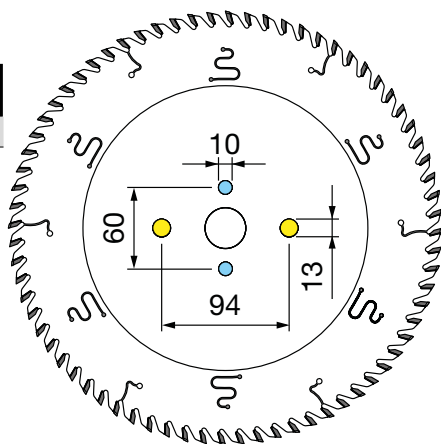

TALÁLJA MEG A TÖKÉLETES LAPSZABÁSZ KÖRFÜRÉSZ KÉSZLETET GÉPTÍPUSONKÉNT

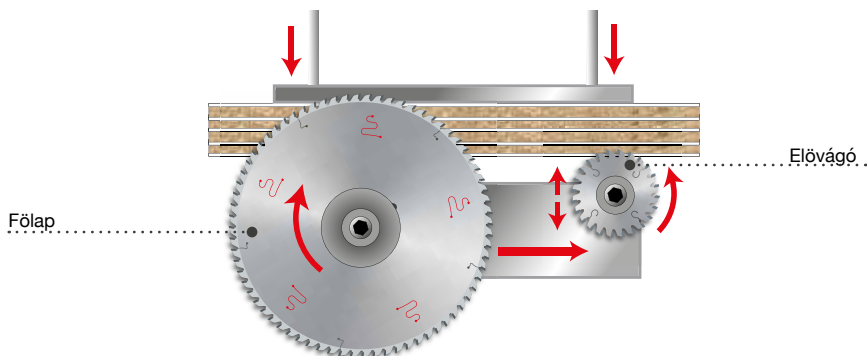

Géptípus	Laptípus	D	B-B1	b	d	Z	Fogtípus	α	β	ill. furatok	Freud kód	Cikksz.
BIESSE-SELCO												
EB 70 (L)	Főlap	300	4,4	3	65	60	TCG	15°	15°	2/9/110	LSB30002X	F03FS09159
	Elővágó	200	4,3-5,5	3,2	65	36	ATB	8°	15°	2/9/100 + 2/9/110	LI25M43PI3	F03FS02681
	Elővágó	300	4,3-5,5	3	65	48	ATB	12°	15°	2/9/100 + 2/9/110	LI25M43RX3	F03FS07616
	Dia Elővágó	200	4,3-5,1	3,2	65	36	FLAT	6°	14°	2/9/100 + 2/9/110	DLI25M43PIH4	F03FS09625
	Dia Elővágó	200	4,3-5,1	3,2	65	36	FLAT	6°	14°	2/9/100 + 2/9/110	DLI25M43PIH6	F03FS09626
	Utófor. elővágó	300	4,55	3,2	65	72	ATB	15°	15°	2/9/100 + 2/9/110	LI27M DA3	F03FS02737
EB 70 (KIT 80), 75 (SEKTOR 430), 80 (SEKTOR 450), SK350, SK450	Főlap	320	4,4	3,2	65	60	TCG	15°	15°	2/9/110	LSB32003X	F03FS09161
	Főlap	320	4,4	3,2	65	72	TCG	15°	15°	2/9/95 + 2/9/110	LSB32001X	F03FS07805
	Elővágó	200	4,3-5,5	3,2	65	36	ATB	8°	15°	2/9/100 + 2/9/110	LI25M43PI3	F03FS02681
	Elővágó	300	4,3-5,5	3	65	48	ATB	12°	15°	2/9/100 + 2/9/110	LI25M43RX3	F03FS07616
	Dia Elővágó	200	4,3-5,1	3,2	65	36	FLAT	6°	14°	2/9/100 + 2/9/110	DLI25M43PIH4	F03FS09625
	Dia Elővágó	200	4,3-5,1	3,2	65	36	FLAT	6°	14°	2/9/100 + 2/9/110	DLI25M43PIH6	F03FS09626
WN2, WN230, SK230	Utófor. elővágó	300	4,55	3,2	65	72	ATB	15°	15°	2/9/100 + 2/9/110	LI27M DA3	F03FS02737
	Főlap	320	4,4	3,2	65	72	TCG	15°	15°	2/9/95 + 2/9/110	LSB32001X	F03FS07805
	Elővágó	200	4,3-5,5	3,2	65	36	ATB	8°	15°	2/9/100 + 2/9/110	LI25M43PI3	F03FS02681
	Dia Elővágó	200	4,3-5,1	3,2	65	36	FLAT	6°	14°	2/9/100 + 2/9/110	DLI25M43PIH4	F03FS09625
	Dia Elővágó	200	4,3-5,1	3,2	65	36	FLAT	6°	14°	2/9/100 + 2/9/110	DLI25M43PIH6	F03FS09626

Géptípus	Laptípus	D	B-B1	b	d	Z	Fogtípus	α	β	ill. furatok	Freud kód	Cikksz.
		mm	mm	mm	mm							
WN 250	Fólap	350	4,4	3,2	65	72	TCG	15°	15°	2/9/110	LSB35013X	F03FS09659
	Elővágó	200	4,3-5,5	3,2	65	36	ATB	8°	15°	2/9/100 + 2/9/110	LI25M43PI3	F03FS02681
	Dia Elővágó	200	4,3-5,1	3,2	65	36	FLAT	6°	14°	2/9/100 + 2/9/110	DLI25M43PIH4	F03FS09625
	Dia Elővágó	200	4,3-5,1	3,2	65	36	FLAT	6°	14°	2/9/100 + 2/9/110	DLI25M43PIH6	F03FS09626
EB 95, SEKTOR 470, K470, SK370	Fólap	355	4,4	3,2	65	72	TCG	15°	15°	2/9/95 + 2/9/110	LSB35508X	F03FS08740
	Elővágó	200	4,3-5,5	3,2	65	36	ATB	8°	15°	2/9/100 + 2/9/110	LI25M43PI3	F03FS02681
	Elővágó	300	4,3-5,5	3	65	48	ATB	12°	15°	2/9/100 + 2/9/110	LI25M43RX3	F03FS07616
	Dia Elővágó	200	4,3-5,1	3,2	65	36	FLAT	6°	14°	2/9/100 + 2/9/110	DLI25M43PIH4	F03FS09625
	Dia Elővágó	200	4,3-5,1	3,2	65	36	FLAT	6°	14°	2/9/100 + 2/9/110	DLI25M43PIH6	F03FS09626
	Utófor. elővágó	300	4,55	3,2	65	72	ATB	15°	15°	2/9/100 + 2/9/110	LI27M DA3	F03FS02737
EB100	Fólap	360	4,4	3,2	65	72	TCG	15°	15°	2/9/95 + 2/9/110	LSB36002X	F03FS07673
	Elővágó	200	4,3-5,5	3,2	65	36	ATB	8°	15°	2/9/100 + 2/9/110	LI25M43PI3	F03FS02681
	Elővágó	300	4,3-5,5	3	65	48	ATB	12°	15°	2/9/100 + 2/9/110	LI25M43RX3	F03FS07616
	Dia Elővágó	200	4,3-5,1	3,2	65	36	FLAT	6°	14°	2/9/100 + 2/9/110	DLI25M43PIH4	F03FS09625
	Dia Elővágó	200	4,3-5,1	3,2	65	36	FLAT	6°	14°	2/9/100 + 2/9/110	DLI25M43PIH6	F03FS09626
	Utófor. elővágó	300	4,55	3,2	65	72	ATB	15°	15°	2/9/100 + 2/9/110	LI27M DA3	F03FS02737
WN-WNA 610, WN-WNA 610 (PFS)	Fólap	380	4,4	3,2	65	72	TCG	15°	15°	2/9/110	LSB38014X	F03FS09166
	Elővágó	200	4,3-5,5	3,2	65	36	ATB	8°	15°	2/9/100 + 2/9/110	LI25M43PI3	F03FS02681
	Elővágó	300	4,3-5,5	3	65	48	ATB	12°	15°	2/9/100 + 2/9/110	LI25M43RX3	F03FS07616
	Dia Elővágó	200	4,3-5,1	3,2	65	36	FLAT	6°	14°	2/9/100 + 2/9/110	DLI25M43PIH4	F03FS09625
EB108, EB110, EB120	Dia Elővágó	200	4,3-5,1	3,2	65	36	FLAT	6°	14°	2/9/100 + 2/9/110	DLI25M43PIH6	F03FS09626
	Fólap	400	4,4	3,2	80	72	TCG	15°	15°	2/15/105 + 2/9/130 + 4/19/120	LSB40009X	F03FS07810
	Elővágó	200	4,3-5,5	3,2	65	36	ATB	8°	15°	2/9/100 + 2/9/110	LI25M43PI3	F03FS02681
	Elővágó	300	4,3-5,5	3	65	48	ATB	12°	15°	2/9/100 + 2/9/110	LI25M43RX3	F03FS07616
	Dia Elővágó	200	4,3-5,1	3,2	65	36	FLAT	6°	14°	2/9/100 + 2/9/110	DLI25M43PIH4	F03FS09625
	Dia Elővágó	200	4,3-5,1	3,2	65	36	FLAT	6°	14°	2/9/100 + 2/9/110	DLI25M43PIH6	F03FS09626
Utófor. elővágó	300	4,55	3,2	65	72	ATB	15°	15°	2/9/100 + 2/9/110	LI27M DA3	F03FS02737	

Géptípus	Laptípus	D	B-B1	b	d	Z	Fogtípus	α	β	ill. furatok	Freud kód	Cikksz.
		mm	mm	mm	mm	mm	mm	mm	mm			
WN-WNA 630, WN-WNA 630 (PFS)	Fólap	400	4,4	3,2	65	72	TCG	15°	15°	2/9/110	LSB40016X	F03FS09172
	Elővágó	200	4,3-5,5	3,2	65	36	ATB	8°	15°	2/9/100 + 2/9/110	LI25M43PI3	F03FS02681
	Dia Elővágó	200	4,3-5,1	3,2	65	36	FLAT	6°	14°	2/9/100 + 2/9/110	DLI25M43PIH4	F03FS09625
	Dia Elővágó	200	4,3-5,1	3,2	65	36	FLAT	6°	14°	2/9/100 + 2/9/110	DLI25M43PIH6	F03FS09626
	Fólap	430	4,4	3,2	80	72	TCG	15°	15°	2/9/130 + 2/14/110 + 4/19/120	LSB43009X	F03FS07909
EB/EBT 120, WN 125	Elővágó	200	4,3-5,5	3,2	65	36	ATB	8°	15°	2/9/100 + 2/9/110	LI25M43PI3	F03FS02681
	Elővágó	300	4,3-5,5	3,2	65	72	ATB	12°	15°	2/9/100 + 2/9/110	LI25M43RI3	F03FS02689
	Dia Elővágó	200	4,3-5,1	3,2	65	36	FLAT	6°	14°	2/9/100 + 2/9/110	DLI25M43PIH4	F03FS09625
	Dia Elővágó	200	4,3-5,1	3,2	65	36	FLAT	6°	14°	2/9/100 + 2/9/110	DLI25M43PIH6	F03FS09626
	Utófor. elővágó	300	4,55	3,2	65	72	ATB	15°	15°	2/9/100 + 2/9/110	LI27M DA3	F03FS02737
WN-WNA 650, WN-WNA 650 (PFS)	Fólap	430	4,4	3,2	65	72	TCG	15°	15°	2/9/110	LSB43012X	F03FS09178
	Elővágó	200	4,3-5,5	3,2	65	36	ATB	8°	15°	2/9/100 + 2/9/110	LI25M43PI3	F03FS02681
	Elővágó	300	4,3-5,5	3	65	48	ATB	12°	15°	2/9/100 + 2/9/110	LI25M43RX3	F03FS07616
	Dia Elővágó	200	4,3-5,1	3,2	65	36	FLAT	6°	14°	2/9/100 + 2/9/110	DLI25M43PIH4	F03FS09625
	Dia Elővágó	200	4,3-5,1	3,2	65	36	FLAT	6°	14°	2/9/100 + 2/9/110	DLI25M43PIH6	F03FS09626
WN 710, WN 710 (PFS)	Fólap	430	4,8	3,5	70	72	TCG	15°	15°	4/11/130	LSB43013X	F03FS09180
	Elővágó	200	4,7-5,9	3,5	65	36	ATB	8°	15°	2/9/100 + 2/9/110	LI25M47PI3	F03FS02720
	Elővágó	300	4,7-5,9	3,5	65	48	ATB	6°	15°	2/9/110	LI25M47RX3	F03FS07744
	Dia Elővágó	200	4,7-5,5	3,5	65	36	FLAT	6°	14°	2/9/100 + 2/9/110	DLI25M47PIH4	F03FS09631
	Dia Elővágó	200	4,7-5,5	3,5	65	36	FLAT	6°	14°	2/9/100 + 2/9/110	DLI25M47PIH6	F03FS09632
WN 600/132, WN 200	Fólap	450	4,8	3,5	80	72	TCG	15°	15°	2/14/125 + 2/9/130 + 4/19/120	LSB45018X	F03FS07812
	Elővágó	200	4,7-5,9	3,5	65	36	ATB	8°	15°	2/9/100 + 2/9/110	LI25M47PI3	F03FS02720
	Dia Elővágó	200	4,7-5,5	3,5	65	36	FLAT	6°	14°	2/9/100 + 2/9/110	DLI25M47PIH4	F03FS09631
	Dia Elővágó	200	4,7-5,5	3,5	65	36	FLAT	6°	14°	2/9/100 + 2/9/110	DLI25M47PIH6	F03FS09632
	Utófor. elővágó	300	4,95	3	65	72	ATB	15°	15°	2/9/100 + 2/9/110	LI27M DB3	F03FS02739

Géptípus	Laptípus	D	B-B1	b	d	Z	Fogtípus	α	β	ill. furatok	Freud kód	Cikksz.
		mm	mm	mm	mm							
WN 600/132, WN 200	Fólap	450	4,8	3,5	80	72	TCG	15°	15°	2/14/125 + 2/9/130 + 4/19/120	LSB45018X	F03FS07812
	Elővágó	200	4,7-5,9	3,5	65	36	ATB	8°	15°	2/9/100 + 2/9/110	LI25M47PI3	F03FS02720
	Dia Elővágó	200	4,7-5,5	3,5	65	36	FLAT	6°	14°	2/9/100 + 2/9/110	DLI25M47PIH4	F03FS09631
	Dia Elővágó	200	4,7-5,5	3,5	65	36	FLAT	6°	14°	2/9/100 + 2/9/110	DLI25M47PIH6	F03FS09632
	Utófor. elővágó	300	4,95	3	65	72	ATB	15°	15°	2/9/100 + 2/9/110	LI27M DB3	F03FS02739
WN-WNA 730, WN-WNA 730 (PFS)	Fólap	470	4,8	3,5	70	72	TCG	15°	15°	4/11/130	LSB47005X	F03FS09185
	Elővágó	200	4,7-5,9	3,5	65	36	ATB	8°	15°	2/9/100 + 2/9/110	LI25M47PI3	F03FS02720
	Elővágó	300	4,7-5,9	3,5	65	48	ATB	6°	15°	2/9/110	LI25M47RX3	F03FS07744
	Dia Elővágó	200	4,7-5,5	3,5	65	36	FLAT	6°	14°	2/9/100 + 2/9/110	DLI25M47PIH4	F03FS09631
	Dia Elővágó	200	4,7-5,5	3,5	65	36	FLAT	6°	14°	2/9/100 + 2/9/110	DLI25M47PIH6	F03FS09632
WN-WNA 750, WN-WNA 750 (PFS)	Fólap	470	4,8	3,5	70	72	TCG	15°	15°	4/11/130	LSB47005X	F03FS09185
	Fólap	520	4,8	3,5	70	72	TCG	15°	15°	4/11/130	LSB52006X	F03FS09193
	Elővágó	200	5,7-6,9	3,5	65	36	ATB	8°	15°	2/9/110	LI25M57PI3BS	F03FS08165
WN 600/145, WN 512	Fólap	480	4,8	3,5	80	72	TCG	15°	15°	2/9/130 + 4/19/120	LSB48001X	F03FS09188
	Elővágó	200	4,7-5,9	3,5	65	36	ATB	8°	15°	2/9/100 + 2/9/110	LI25M47PI3	F03FS02720
	Dia Elővágó	200	4,7-5,5	3,5	65	36	FLAT	6°	14°	2/9/100 + 2/9/110	DLI25M47PIH4	F03FS09631
	Dia Elővágó	200	4,7-5,5	3,5	65	36	FLAT	6°	14°	2/9/100 + 2/9/110	DLI25M47PIH6	F03FS09632
	Utófor. elővágó	300	4,55	3,2	65	72	ATB	15°	15°	2/9/100 + 2/9/110	LI27M DA3	F03FS02737
WNA600/162	Fólap	510	4,8	3,5	80	72	TCG	15°	15°	2/9/130 + 4/19/120	LSB51001X	F03FS09984
	Elővágó	200	4,7-5,9	3,5	65	36	ATB	8°	15°	2/9/100 + 2/9/110	LI25M47PI3	F03FS02720
	Dia Elővágó	200	4,7-5,5	3,5	65	36	FLAT	6°	14°	2/9/100 + 2/9/110	DLI25M47PIH4	F03FS09631
	Dia Elővágó	200	4,7-5,5	3,5	65	36	FLAT	6°	14°	2/9/100 + 2/9/110	DLI25M47PIH6	F03FS09632
	Utófor. elővágó	300	4,95	3	65	72	ATB	15°	15°	2/9/100 + 2/9/110	LI27M DB3	F03FS02739
WN-WNA 850	Fólap	600	5,8	4	70	60	TCG	15°	15°	4/11/130	LSB60004X	F03FS10258
	Fólap	600	5,8	4	75	60	TCG	15°	15°	4/6,5/130 + 4/11/130	LSB60006X	F03FS10259
	Elővágó	200	5,7-6,9	3,5	65	36	ATB	8°	15°	2/9/110	LI25M57PI3BS	F03FS08165

Géptípus	Laptípus	D	B-B1	b	d	Z	Fogtípus	α	β	ill. furatok	Freud kód	Cikksz.
		mm	mm	mm	mm							
AES												
ALPHA PS-03	Fólap	320	4,4	3,2	30	72	TCG	15°	15°	2/10/60 + 2/13/94	LSB32009X	F03FS10296
	Elővágó	200	4,3-5,5	3,2	20	36	ATB	8°	15°	2/10/60 + 2/9/62 + 2/11/66	LI25M43PA3	F03FS02670
ALPHA PS-05	Fólap	430	4,4	3,2	30	72	TCG	15°	15°	2/13/94	LSB43007X	F03FS09177
	Elővágó	200	4,3-5,5	3,2	20	36	ATB	8°	15°	2/11/66 + 2/10/60 + 2/9/62	LI25M43PA3	F03FS02670
ALPHA PS-06	Fólap	460	4,4	3,2	30	72	TCG	15°	15°	2/13/94	LSB46001X	F03FS08922
	Elővágó	200	4,3-5,5	3,2	20	36	ATB	8°	15°	2/11/66 + 2/10/60 + 2/9/62	LI25M43PA3	F03FS02670
ANTHON												
LN (90)	Fólap	400	4,4	3,2	60	72	TCG	15°	15°	2/14/100 + 2/11/85	LSB40017X	F03FS09272
	Elővágó	180	4,3-5,5	3,2	20	28	ATB	8°	15°	-	LI25M43NA3	F03FS02661
	Elővágó	180	4,3-5,5	3,2	20	36	ATB	8°	15°	-	LI25M43XA3	F03FS06372
PORTA 100	Fólap	400	4,4	3,2	60	72	TCG	15°	15°	2/14/100 + 2/11/85	LSB40017X	F03FS09272
	Elővágó	180	4,3-5,5	3,2	20	36	ATB	8°	15°	-	LI25M43XA3	F03FS06372
LNA (100), LN (120)	Fólap	450	4,4	3,2	60	72	TCG	15°	15°	2/14/125	LSB45008X	F03FS09182
	Elővágó	180	4,3-5,5	3,2	20	36	ATB	8°	15°	-	LI25M43XA3	F03FS06372
PORTA 150	Fólap	500	4,8	3,5	60	60	TCG	15°	15°	2/11/115	LSB50009X	F03FS09189
	Elővágó	180	4,3-5,5	3,2	20	36	ATB	8°	15°	-	LI25M43XA3	F03FS06372
AYZA MIZRAK												
LANZA P3	Fólap	320	4,4	3,2	65	60	TCG	15°	15°	2/9/110	LSB32003X	F03FS09161
	Fólap	320	4,4	3,2	65	72	TCG	15°	15°	2/9/95 + 2/9/110	LSB32001X	F03FS07805
	Elővágó	200	4,3-5,5	3,2	65	36	ATB	8°	15°	2/9/100 + 2/9/110	LI25M43PI3	F03FS02681
	Fólap	360	4,4	3,2	65	60	TCG	15°	15°	2/9/110	LSB36001X	F03FS10227
	Fólap	360	4,4	3,2	65	72	TCG	15°	15°	2/9/95 + 2/9/110	LSB36002X	F03FS07673
	Elővágó	200	4,3-5,5	3,2	65	36	ATB	8°	15°	2/9/100 + 2/9/110	LI25M43PI3	F03FS02681
LANZA P4	Fólap	380	4,4	3,2	65	72	TCG	15°	15°	2/9/110	LSB38014X	F03FS09166
	Elővágó	200	4,3-5,5	3,2	65	36	ATB	8°	15°	2/9/100 + 2/9/110	LI25M43PI3	F03FS02681
LANZA P5	Fólap	400	4,4	3,2	65	72	TCG	15°	15°	2/9/110	LSB40016X	F03FS09172
	Elővágó	200	4,3-5,5	3,2	65	36	ATB	8°	15°	2/9/100 + 2/9/110	LI25M43PI3	F03FS02681
LANZA P5 CARRERA	Fólap	400	4,4	3,2	65	72	TCG	15°	15°	2/9/110	LSB40016X	F03FS09172
	Elővágó	200	4,3-5,5	3,2	65	36	ATB	8°	15°	2/9/100 + 2/9/110	LI25M43PI3	F03FS02681

Géptípus	Laptípus	D	B-B1	b	d	Z	Fogtípus	α	β	ill. furatok	Freud kód	Cikksz.
		mm	mm	mm	mm							
FELDER MAYER												
KAPPA AUTOMATIC 80	Fólap	320	4,4	3,2	30	60	TCG	15°	15°	2/10/60	LSB32005X	F03FS09160
	Fólap	320	4,4	3,2	30	72	TCG	15°	15°	2/10/60 + 2/13/94	LSB32009X	F03FS10296
	Elővágó	150	4,3-5,6	3,2	30	36	ATB	8°	15°	-	LI25M43KC3	F03FS02649
KAPPA AUTOMATIC 80 EDITION	Fólap	320	4,4	3,2	30	60	TCG	15°	15°	2/10/60	LSB32005X	F03FS09160
	Elővágó	150	4,3-5,6	3,2	30	36	ATB	8°	15°	-	LI25M43KC3	F03FS02649
KAPPA AUTOMATIC CLASSIC	Fólap	320	4,4	3,2	30	60	TCG	15°	15°	2/10/60	LSB32005X	F03FS09160
	Elővágó	150	4,3-5,6	3,2	30	36	ATB	8°	15°	-	LI25M43KC3	F03FS02649
PS80	Fólap	320	4,4	3,2	30	60	TCG	15°	15°	2/10/60	LSB32005X	F03FS09160
	Elővágó	150	4,3-5,6	3,2	30	36	ATB	8°	15°	-	LI25M43KC3	F03FS02649
KAPPA AUTOMATIC 100	Fólap	355	4,4	3,2	30	72	TCG	15°	15°	2/10/60	LSB35504X	F03FS07674
	Elővágó	150	4,3-5,6	3,2	30	36	ATB	8°	15°	-	LI25M43KC3	F03FS02649
PS80 PREMIUM	Fólap	355	4,4	3,2	30	72	TCG	15°	15°	2/10/60	LSB35504X	F03FS07674
	Elővágó	150	4,3-5,6	3,2	30	36	ATB	8°	15°	-	LI25M43KC3	F03FS02649
KAPPA AUTOMATIC 120	Fólap	400	4,4	3,2	30	48	TCG	15°	15°	2/10/60	LSB40001X	F03FS09168
	Fólap	400	4,4	3,2	30	60	TCG	15°	15°	2/10/60	LSB40004X	F03FS09169
	Fólap	400	4,4	3,2	30	72	TCG	15°	15°	2/10/60 + 2/13/94	LSB40007X	F03FS07725
	Elővágó	150	4,3-5,6	3,2	30	36	ATB	8°	15°	-	LI25M43KC3	F03FS02649
PS100	Fólap	400	4,4	3,2	30	48	TCG	15°	15°	2/10/60	LSB40001X	F03FS09168
	Fólap	400	4,4	3,2	30	60	TCG	15°	15°	2/10/60	LSB40004X	F03FS09169
	Fólap	400	4,4	3,2	30	72	TCG	15°	15°	2/10/60 + 2/13/94	LSB40007X	F03FS07725
	Elővágó	150	4,3-5,6	3,2	30	36	ATB	8°	15°	-	LI25M43KC3	F03FS02649
PS2 Z	Fólap	450	4,4	3,2	30	72	TCG	15°	15°	2/10/60 + 2/14/95	LSB45007X	F03FS09181
	Elővágó	150	4,3-5,6	3,2	30	36	ATB	8°	15°	-	LI25M43KC3	F03FS02649
KAPPA AUTOMATIC 140	Fólap	450	4,4	3,2	30	72	TCG	15°	15°	2/10/60 + 2/14/95	LSB45007X	F03FS09181
	Elővágó	150	4,3-5,6	3,2	30	36	ATB	8°	15°	-	LI25M43KC3	F03FS02649
FIMAL												
CONCEPT 350	Fólap	350	4,4	3,2	30	72	TCG	15°	15°	2/10/60	LSB35003X	F03FS07630
	Fólap	300	4,4	3	30	60	TCG	15°	15°	2/10/60	LSB30001X	F03FS07802
KR32	Fólap	350	4,4	3,2	30	72	TCG	15°	15°	2/10/60	LSB35003X	F03FS07630
KR43	Fólap	350	4,4	3,2	30	72	TCG	15°	15°	2/10/60	LSB35003X	F03FS07630

Géptípus	Laptípus	D	B-B1	b	d	Z	Fogtípus	α	β	ill. furatok	Freud kód	Cikksz.
		mm	mm	mm	mm							
GIBEN												
MK, GAMMA, N, ST, SE, TREND	Fólap	355	4,4	3,2	75	72	TCG	15°	15°	4/15/105 + 2/7/110	LSB35505X	F03FS07633
	Elővágó	125	4,3-5,5	3,2	45	24	ATB	0°	15°	-	LI25M43FE3	F03FS02645
SMART SP105, ICON 105	Fólap	380	4,4	3,2	50	72	TCG	15°	15°	4/13/80	LSB38008X	F03FS09165
	Elővágó	250	4,3-5,5	3,2	50	48	ATB	8°	15°	3/13/80	LI25M430F3	F03FS02669
G 2000 STARMATIC	Fólap	400	4,4	3,2	75	72	TCG	15°	15°	4/15/105 + 2/7/110 + 2/14/100	LSB40008X	F03FS07726
	Fólap	400	4,4	3,2	75	84	TCG	15°	15°	4/15/105 + 2/7/110	LSB40019X	F03FS08990
	Elővágó	125	4,5-5,7	3	45	24	ATB	0°	15°	-	LI25M45FE3	F03FS02699
PRISMATIC 101	Fólap	400	4,4	3,2	75	72	TCG	15°	15°	4/15/105 + 2/7/110 + 2/14/100	LSB40008X	F03FS07726
	Elővágó	160	4,3-5,5	3,2	45	36	ATB	8°	15°	03/11/70	LI25M43LE3	F03FS02655
PRISMATIC 201	Fólap	400	4,4	3,2	75	72	TCG	15°	15°	4/15/105 + 2/7/110 + 2/14/100	LSB40008X	F03FS07726
	Fólap	430	4,4	3,2	75	72	TCG	15°	15°	4/15/105 + 2/7/110	LSB43008X	F03FS07908
	Elővágó	215	4,3-5,5	3,2	50	42	ATB	8°	15°	2/7/80 + 3/15/80	LI25M430F3	F03FS02685
	Elővágó	300	4,3-5,5	3,5	50	48	ATB	12°	15°	3/15/80	LI25M43RM3	F03FS02693
	Dia Elővágó	215	4,3-5,1	3,2	50	42	FLAT	6°	14°	2/7/80 + 3/15/80	DLI25M43QFH4	F03FS09633
	Dia Elővágó	215	4,3-5,1	3,2	50	42	FLAT	6°	14°	2/7/80 + 3/15/80	DLI25M43QFH6	F03FS09634
	Utófor. Elővágó	300	4,55	3,2	50	72	ATB	15°	15°	3/15/80	LI27M DD3	F03FS02743
PRISMATIC 2, 3	Fólap	470	4,4	3,2	75	96	TCG	15°	15°	4/15/105	LSB47004X	F03FS09184
	Elővágó	215	4,3-5,5	3,2	50	42	ATB	8°	15°	2/7/80 + 3/15/80	LI25M430F3	F03FS02685
	Elővágó	215	4,5-5,7	3,2	50	42	ATB	8°	15°	3/15/80	LI25M45PF3	F03FS02713
	Elővágó	300	4,3-5,5	3,5	50	48	ATB	12°	15°	3/15/80	LI25M43RM3	F03FS02693
	Dia Elővágó	215	4,3-5,1	3,2	50	42	FLAT	6°	14°	2/7/80 + 3/15/80	DLI25M43QFH4	F03FS09633
	Dia Elővágó	215	4,3-5,1	3,2	50	42	FLAT	6°	14°	2/7/80 + 3/15/80	DLI25M43QFH6	F03FS09634
	Utófor. Elővágó	300	4,55	3,2	50	72	ATB	15°	15°	3/15/80	LI27M DD3	F03FS02743
ICONFAST LM D-816	Fólap	530	4,8	3,5	75	72	TCG	15°	15°	2/7/110	LSB53004X	F03FS09651
	Elővágó	215	4,7-5,9	3,5	50	42	ATB	8°	15°	2/7/80	LI25M470F3	F03FS09650

Géptípus	Laptípus	D	B-B1	b	d	Z	Fogtípus	α	β	ill. furatok	Freud kód	Cikksz.
		mm	mm	mm	mm							
HOLZHER												
CUT 85, 82	Fólap	350	4,4	3,2	30	72	TCG	15°	15°	2/10/60	LSB35003X	F03FS07630
	Elővágó	180	4,3-5,5	3,2	30	28	ATB	8°	15°	2/7/42 + 2/10/60	LI25M43NC3	F03FS02663
	Elővágó	180	4,3-5,5	3,2	30	36	ATB	8°	15°	2/7/42 + 2/10/60	LI25M43XN3	F03FS06373
	Utófor. elővágó	250	4,6	3,0	30	48	ATB	15°	15°	-	LI27M BA3	F03FS02734
TECTRA 6120 CLASSIC	Fólap	350	4,4	3,2	30	72	TCG	15°	15°	2/10/60	LSB35003X	F03FS07630
	Elővágó	180	4,3-5,5	3,2	30	36	ATB	8°	15°	2/7/42 + 2/10/60	LI25M43XN3	F03FS06373
CUT 110	Fólap	400	4,4	3,2	30	72	TCG	15°	15°	2/10/60 + 2/13/94	LSB40007X	F03FS07725
	Elővágó	250	4,3-5,5	3,2	30	48	CON	8°	15°	2/10/60	LI25M430C3	F03FS02668
	Utófor. elővágó	250	4,6	3,0	30	48	ATB	15°	15°	-	LI27M BA3	F03FS02734
ZENTREX 6220 (POWER, LIFT, DYNAMIC)	Fólap	430	4,4	3,2	30	72	TCG	15°	15°	2/13/94	LSB43007X	F03FS09177
	Elővágó	180	4,3-5,5	3,2	30	36	ATB	8°	15°	2/7/42 + 2/10/60	LI25M43XN3	F03FS06373
HOLZMA												
HPP130	Fólap	300	4,4	3,2	60	72	TCG	15°	15°	2/14/100	LSB30012X	F03FS09207
	Dia Elővágó	180	4,3-5,1	3,2	45	30	FLAT	6°	14°	-	DLI25M43NEH4	F03FS09621
	Dia Elővágó	180	4,3-5,1	3,2	45	30	FLAT	6°	14°	-	DLI25M43NEH6	F03FS09622
	Elővágó	180	4,3-5,5	3,2	45	36	CON	8°	15°	-	LI25M43NE3	F03FS02664
HPP230, 250 (before 06/2014)	Fólap	300	4,4	3,2	60	72	TCG	15°	15°	2/14/100	LSB30012X	F03FS09207
	Fólap	350	4,4	3,2	60	72	TCG	15°	15°	2/14/100	LSB35004X	F03FS07636
	Elővágó	200	4,3-5,5	3,2	45	36	ATB	8°	15°	-	LI25M43PE3	F03FS02676
	Elővágó	180	4,3-5,5	3,2	45	36	ATB	8°	15°	-	LI25M43NE3	F03FS02664
	Dia Elővágó	180	4,3-5,1	3,2	45	30	FLAT	6°	14°	-	DLI25M43NEH4	F03FS09621
	Dia Elővágó	180	4,3-5,1	3,2	45	30	FLAT	6°	14°	-	DLI25M43NEH6	F03FS09622
SAWTEQ B-200	Fólap	310	4,4	3,2	60	72	TCG	15°	15°	2/14/100	LSB31001X	F03FS09949
	Elővágó	200	4,3-5,5	3,2	45	36	ATB	8°	15°	-	LI25M43PE3	F03FS02676
HPP350	Fólap	350	4,4	3,2	75	72	TCG	15°	15°	-	LSB35008X	F03FS07634
	Elővágó	180	4,3-5,5	3,2	45	36	ATB	8°	15°	-	LI25M43NE3	F03FS02664
	Dia Elővágó	180	4,3-5,1	3,2	45	30	FLAT	6°	14°	-	DLI25M43NEH4	F03FS09621
	Dia Elővágó	180	4,3-5,1	3,2	45	30	FLAT	6°	14°	-	DLI25M43NEH6	F03FS09622

Géptípus	Laptípus	D	B-B1	b	d	Z	Fogtípus	α	β	ill. furatok	Freud kód	Cikksz.
		mm	mm	mm	mm	mm	mm	mm	mm			
HPP180	Fólap	380	4,4	3,2	60	72	TCG	15°	15°	2/14/100	LSB38002X	F03FS07631
	Elővágó	180	4,3-5,5	3,2	45	36	ATB	8°	15°	-	LI25M43NE3	F03FS02664
	Dia Elővágó	180	4,3-5,1	3,2	45	30	FLAT	6°	14°	-	DLI25M43NEH4	F03FS09621
	Dia Elővágó	180	4,3-5,1	3,2	45	30	FLAT	6°	14°	-	DLI25M43NEH6	F03FS09622
HPP380, 82	Fólap	380	4,4	3,2	60	72	TCG	15°	15°	2/14/100	LSB38002X	F03FS07631
	Fólap	380	4,8	3,5	60	72	TCG	15°	15°	2/14/100	LSB38004X	F03FS07632
	Fólap	380	4,8	3,5	60	84	TCG	15°	15°	2/14/100	LSB38005X	F03FS07807
	Elővágó	180	4,3-5,5	3,2	45	36	ATB	8°	15°	-	LI25M43NE3	F03FS02664
	Elővágó	180	4,7-5,9	3,5	45	36	ATB	8°	15°	-	LI25M47NE3	F03FS02715
	Dia Elővágó	180	4,3-5,1	3,2	45	30	FLAT	6°	14°	-	DLI25M43NEH4	F03FS09621
	Dia Elővágó	180	4,3-5,1	3,2	45	30	FLAT	6°	14°	-	DLI25M43NEH6	F03FS09622
	Dia Elővágó	180	4,7-5,5	3,5	45	30	FLAT	6°	14°	-	DLI25M47NEH4	F03FS09623
	Dia Elővágó	180	4,7-5,5	3,5	45	30	FLAT	6°	14°	-	DLI25M47NEH6	F03FS09624
	Utófor. elővágó	280	5,0	3,5	45	84	ATB	15°	15°	-	LI27M CA3	F03FS02736
HPL410	Fólap	420	4,8	3,5	60	60	TCG	15°	15°	2/14/125	LSB42001X	F03FS10234
	Fólap	420	4,8	3,5	60	84	TCG	15°	15°	2/14/100 + 2/14/125	LSB42002X	F03FS09176
	Elővágó	180	4,7-5,9	3,5	45	36	ATB	8°	15°	-	LI25M47NE3	F03FS02715
	Dia Elővágó	180	4,7-5,5	3,5	45	30	FLAT	6°	14°	-	DLI25M47NEH4	F03FS09623
	Dia Elővágó	180	4,7-5,5	3,5	45	30	FLAT	6°	14°	-	DLI25M47NEH6	F03FS09624
	Utófor. elővágó	340	5,0	3,5	45	108	ATB	15°	15°	3/14/65	LI27M EB3	F03FS02747
HPP430, 510, 11	Fólap	450	4,8	3,5	60	72	TCG	15°	15°	2/14/125 + 2/17/100	LSB45017X	F03FS07391
	Elővágó	180	4,7-5,9	3,5	45	36	ATB	8°	15°	-	LI25M47NE3	F03FS02715
	Dia Elővágó	180	4,7-5,5	3,5	45	30	FLAT	6°	14°	-	DLI25M47NEH4	F03FS09623
	Dia Elővágó	180	4,7-5,5	3,5	45	30	FLAT	6°	14°	-	DLI25M47NEH6	F03FS09624
	Utófor. elővágó	340	5,0	3,5	45	108	ATB	15°	15°	3/14/65	LI27M EB3	F03FS02747

Géptípus	Laptípus	D	B-B1	b	d	Z	Fogtípus	α	β	ill. furatok	Freud kód	Cikksz.
		mm	mm	mm	mm							
22	Fólap	500	4,8	3,5	60	72	TCG	15°	15°	2/11/115	LSB50011X	F03FS09191
	Elővágó	200	4,7-5,9	3,5	45	36	ATB	8°	15°	-	LI25M47PE3	F03FS02719
	Dia Elővágó	200	4,7-5,5	3,5	45	36	FLAT	6°	14°	-	DLI25M47PEH4	F03FS09629
	Dia Elővágó	200	4,7-5,5	3,5	45	36	FLAT	6°	14°	-	DLI25M47PEH6	F03FS09630
	Utófor. elővágó	340	5,0	3,5	45	108	ATB	15°	15°	3/14/65	LI27M EB3	F03FS02747
HPL550	Fólap	520	4,8	3,5	60	72	TCG	15°	15°	2/11/115 + 2/19/120	LSB52003X	F03FS09192
	Elővágó	200	4,7-5,9	3,5	45	36	ATB	8°	15°	-	LI25M47PE3	F03FS02719
	Dia Elővágó	200	4,7-5,5	3,5	45	36	FLAT	6°	14°	-	DLI25M47PEH4	F03FS09629
	Dia Elővágó	200	4,7-5,5	3,5	45	36	FLAT	6°	14°	-	DLI25M47PEH6	F03FS09630
	Utófor. elővágó	340	5,0	3,5	45	108	ATB	15°	15°	3/14/65	LI27M EB3	F03FS02747
HPL570	Fólap	570	4,8	3,5	60	60	TCG	15°	15°	2/11/115 + 2/19/120	LSB57001X	F03FS09199
	Elővágó	200	4,7-5,9	3,5	45	36	ATB	8°	15°	-	LI25M47PE3	F03FS02719
	Dia Elővágó	200	4,7-5,5	3,5	45	36	FLAT	6°	14°	-	DLI25M47PEH4	F03FS09629
	Dia Elővágó	200	4,7-5,5	3,5	45	36	FLAT	6°	14°	-	DLI25M47PEH6	F03FS09630
	Utófor. elővágó	340	5,0	3,5	45	108	ATB	15°	15°	3/14/65	LI27M EB3	F03FS02747
HPP42, 33	Fólap	600	5,8	4	60	60	TCG	15°	15°	2/11/115 + 2/19/120	LSB60001X	F03FS09200
	Fólap	600	5,8	4	60	72	TCG	15°	15°	2/11/115 + 2/19/120	LSB60002X	F03FS09201
	Elővágó	200	5,7-6,9	4	45	36	ATB	8°	15°	-	LI25M57PE3	F03FS02728
HOMAG												
CH 3	Fólap	300	4,4	3	75	60	TCG	15°	15°	-	LSB30003X	F03FS03916
	Elővágó	125	4,3-5,5	3,2	45	24	ATB	0°	15°	-	LI25M43FE3	F03FS02645
CH 3	Fólap	300	4,4	3	75	60	TCG	15°	15°	-	LSB30003X	F03FS03916
	Elővágó	125	4,3-5,5	3,2	45	24	ATB	0°	15°	-	LI25M43FE3	F03FS02645
CT 04/40	Fólap	300	4,4	3	75	60	TCG	15°	15°	-	LSB30003X	F03FS03916
	Elővágó	150	4,3-5,6	3,2	45	36	ATB	8°	15°	-	LI25M43KE3	F03FS02651
CV'S	Fólap	300	4,4	3	75	60	TCG	15°	15°	-	LSB30003X	F03FS10218
	Elővágó	125	4,3-5,5	3,2	45	24	ATB	0°	15°	-	LI25M43FE3	F03FS02645

Géptípus	Laptípus	D	B-B1	b	d	Z	Fogtípus	α	β	ill. furatok	Freud kód	Cikksz.
		mm	mm	mm	mm							
CH 04	Fólap	355	4,4	3,2	75	72	TCG	15°	15°	3/7/100	LSB35507X	F03FS07710
	Elővágó	180	4,3-5,5	3,2	45	36	ATB	8°	15°	-	LI25M43NE3	F03FS02664
	Dia Elővágó	180	4,3-5,1	3,2	45	30	FLAT	6°	14°	-	DLI25M43NEH4	F03FS09621
	Dia Elővágó	180	4,3-5,1	3,2	45	30	FLAT	6°	14°	-	DLI25M43NEH6	F03FS09622
CH 08/12	Fólap	400	4,4	3,2	75	72	TCG	15°	15°	4/15/105 + 2/7/110 + 2/14/100	LSB40008X	F03FS07726
	Elővágó	150	4,3-5,6	3,2	45	36	ATB	8°	15°	-	LI25M43KE3	F03FS02651
NANXING												
NPC330	Fólap	380	4,4	3,2	60	72	TCG	15°	15°	2/14/100	LSB38002X	F03FS07631
	Fólap	350	4,4	3,2	60	72	TCG	15°	15°	2/14/100	LSB35004X	F03FS07636
	Elővágó	200	4,3-5,5	3,2	45	36	ATB	8°	15°	-	LI25M43PE3	F03FS02676
MJB1327B	Fólap	450	4,8	3,5	60	72	TCG	15°	15°	2/14/125 + 2/17/100	LSB45017X	F03FS09272
	Fólap	400	4,4	3,2	60	84	TCG	15°	15°	2/14/100	LSB40021X	F03FS09255
	Elővágó	180	4,3-5,5	3,2	30	36	ATB	8°	15°	2/7/42 + 2/10/60	LI25M43XN3	F03FS06373
NP280FG NP280F	Fólap	450	4,8	3,5	60	72	TCG	15°	15°	2/14/125 + 2/17/100	LSB45017X	F03FS09272
	Fólap	400	4,4	3,2	60	84	TCG	15°	15°	2/14/100	LSB40021X	F03FS09255
	Fólap	350	4,4	3,2	60	72	TCG	15°	15°	2/14/100	LSB35004X	F03FS07636
	Elővágó	180	4,3-5,5	3,2	30	36	ATB	8°	15°	2/7/42 + 2/10/60	LI25M43XN3	F03FS06373
NPL330HG NP330H NP330HG	Fólap	450	4,8	3,5	60	72	TCG	15°	15°	2/14/125 + 2/17/100	LSB45017X	F03FS07391
	Elővágó	180	4,7-5,9	3,5	45	36	ATB	8°	15°	-	LI25M47NE3	F03FS02715
	Dia Elővágó	180	4,7-5,5	3,5	45	30	FLAT	6°	14°	-	DLI25M47NEH4	F03FS09623
	Dia Elővágó	180	4,7-5,5	3,5	45	30	FLAT	6°	14°	-	DLI25M47NEH6	F03FS09624
NP380FG NP330FG NP330F	Fólap	450	4,8	3,5	60	72	TCG	15°	15°	2/14/125 + 2/17/100	LSB45017X	F03FS09272
	Fólap	400	4,4	3,2	60	84	TCG	15°	15°	2/14/100	LSB40021X	F03FS09255
	Elővágó	180	4,7-5,9	3,5	45	36	ATB	8°	15°	-	LI25M47NE3	F03FS02715
	Dia Elővágó	180	4,7-5,5	3,5	45	30	FLAT	6°	14°	-	DLI25M47NEH4	F03FS09623
	Dia Elővágó	180	4,7-5,5	3,5	45	30	FLAT	6°	14°	-	DLI25M47NEH6	F03FS09624

Géptípus	Laptípus	D	B-B1	b	d	Z	Fogtípus	α	β	ill. furatok	Freud kód	Cikksz.
		mm	mm	mm	mm							
NZH3318 NPD380	Fólap	450	4,8	3,5	60	72	TCG	15°	15°	2/14/125 + 2/17/100	LSB45017X	F03FS07391
	Elővágó	180	4,7-5,9	3,5	45	36	ATB	8°	15°	-	LI25M47NE3	F03FS02715
	Dia Elővágó	180	4,7-5,5	3,5	45	30	FLAT	6°	14°	-	DLI25M47NEH4	F03FS09623
	Dia Elővágó	180	4,7-5,5	3,5	45	30	FLAT	6°	14°	-	DLI25M47NEH6	F03FS09624
NIMAC												
HERMES 70 CNC	Fólap	300	4,4	3	65	72	TCG	15°	15°	2/9/95 + 2/9/110	LSB30006X	F03FS09158
	Fólap	320	4,4	3,2	65	72	TCG	15°	15°	2/9/95 + 2/9/110	LSB32001X	F03FS07805
ATLAS 80	Fólap	320	4,4	3,2	65	72	TCG	15°	15°	2/9/95 + 2/9/110	LSB32001X	F03FS07805
ATLAS 100/100TL	Fólap	355	4,4	3,2	65	72	TCG	15°	15°	2/9/95 + 2/9/110	LSB35508X	F03FS08740
	Fólap	360	4,4	3,2	65	72	TCG	15°	15°	2/9/95 + 2/9/110	LSB36002X	F03FS07673
PANHANS												
EURO 10 SF	Main blade	300	4,4	3	30	60	TCG	15°	15°	2/10/60	LSB30001X	F03FS07802
	Elővágó	250	4,3-5,5	3,2	30	48	CON	8°	15°	2/10/60	LI25M430C3	F03FS02668
EURO 5 (SF, COMPACT, ECOPAN)	Utófor. elővágó	250	4,6	3	30	48	ATB	15°	15°	-	LI27M BA3	F03FS02734
	Main blade	300	4,4	3	30	60	TCG	15°	15°	2/10/60	LSB30001X	F03FS07802
EURO10, 693/SH 70	Elővágó	125	4,3-5,5	3,2	20	24	CON	0°	15°	-	LI25M43FA3	F03FS02643
	Main blade	300	4,4	3	30	60	TCG	15°	15°	2/10/60	LSB30001X	F03FS07802
	Elővágó	125	4,3-5,5	3,2	20	24	CON	0°	15°	-	LI25M43FA3	F03FS02643
S 45	Elővágó	180	4,3-5,5	3,2	30	28	CON	8°	15°	2/7/42 + 2/10/60	LI25M43NC3	F03FS02663
	Main blade	300	4,4	3	30	60	TCG	15°	15°	2/10/60	LSB30001X	F03FS07802
	Main blade	350	4,4	3,2	30	72	TCG	15°	15°	2/10/60	LSB35003X	F03FS07630
EURO 12, 30	Elővágó	180	4,3-5,5	3,2	30	28	CON	8°	15°	2/7/42 + 2/10/60	LI25M43NC3	F03FS02663
	Main blade	350	4,4	3,2	30	72	TCG	15°	15°	2/10/60	LSB35003X	F03FS07630
EURO 12 SF	Main blade	350	4,4	3,2	30	72	TCG	15°	15°	2/10/60	LSB35003X	F03FS07630
	Elővágó	280	4,3-5,5	3,2	30	48	CON	12°	15°	2/10/60	LI25M43VC3	F03FS07419
POLYPAN 47	Main blade	350	4,4	3,2	30	72	TCG	15°	15°	2/10/60	LSB35003X	F03FS07630
	Elővágó	180	4,3-5,5	3,2	30	28	CON	8°	15°	2/7/42 + 2/10/60	LI25M43NC3	F03FS02663
	Utófor. elővágó	300	4,55	3	30	72	ATB	15°	15°	-	LI27M DF3	F03FS02745

Géptípus	Laptípus	D	B-B1	b	d	Z	Fogtípus	α	β	ill. furatok	Freud kód	Cikksz.
		mm	mm	mm	mm							
EUROSTAR 2 XL, POLYSTAR	Main blade	370	4,4	3,2	30	72	TCG	15°	15°	2/10/60	LSB37001	F03FS06312
	Elővágó	180	4,3-5,5	3,2	30	28	CON	8°	15°	2/7/42 + 2/10/60	LI25M43NC3	F03FS02663
	Elővágó	280	4,3-5,5	3,2	30	48	CON	6°	15°	2/10/60	LI25M43VC3	F03FS07419
EURO 32	Main blade	370	4,4	3,2	30	72	TCG	15°	15°	2/10/60	LSB37001X	F03FS10228
	Elővágó	180	4,3-5,5	3,2	30	28	CON	8°	15°	2/7/42 + 2/10/60	LI25M43NC3	F03FS02663
693/SH 110	Main blade	400	4,4	3,2	30	72	TCG	15°	15°	2/10/60 + 2/13/94	LSB40007X	F03FS07725
	Elővágó	180	4,3-5,5	3,2	30	28	CON	8°	15°	2/7/42 + 2/10/60	LI25M43NC3	F03FS02663
EUROSTAR 2 XXL	Main blade	400	4,4	3,2	30	72	TCG	15°	15°	2/10/60 + 2/13/94	LSB40007X	F03FS07725
	Elővágó	180	4,3-5,5	3,2	30	28	CON	8°	15°	2/7/42 + 2/10/60	LI25M43NC3	F03FS02663
	Elővágó	280	4,3-5,5	3,2	30	48	CON	6°	15°	2/10/60	LI25M43VC3	F03FS07419
SCHIEER KOCH												
PA 6000, 5500	Fólap	350	4,4	3,2	30	72	TCG	15°	15°	2/10/60	LSB35003X	F03FS07630
	Elővágó	200	4,3-5,5	3,2	20	36	ATB	8°	15°	2/11/66 + 2/10/60 + 2/9/62	LI25M43PA3	F03FS02670
	Elővágó	200	4,3-5,5	3,2	30	36	ATB	8°	15°	2/9/60 + 2/10/60	LI25M43PC3	F03FS02674
SCHELLING												
FH3	Fólap	300	4,4	3	30	72	TCG	15°	15°	2/10/60	LSB30005X	F03FS07803
	Fólap	350	4,4	3,2	30	72	TCG	15°	15°	2/10/60	LSB35003X	F03FS07630
	Elővágó	180	4,3-5,5	3,2	30	36	ATB	8°	15°	2/7/42 + 2/10/60	LI25M43XN3	F03FS06373
FH4 (till 06/2015)	Fólap	350	4,4	3,2	30	72	TCG	15°	15°	2/10/60	LSB35003X	F03FS07630
	Elővágó	300	4,3-5,5	3,2	30	48	ATB	12°	15°	2/11/73 + 2/11/75 + 2/13/94	LI25M43RC3	F03FS07577
S45	Fólap	350	4,4	3,2	30	72	TCG	15°	15°	2/10/60	LSB35003X	F03FS07630
	Fólap	400	4,4	3,2	30	72	TCG	15°	15°	2/10/60 + 2/13/94	LSB40007X	F03FS07725
	Elővágó	180	4,3-5,5	3,2	30	36	ATB	8°	15°	2/7/42 + 2/10/60	LI25M43XN3	F03FS06373
	Elővágó	300	4,3-5,5	3,2	30	48	ATB	12°	15°	2/11/73 + 2/11/75 + 2/13/94	LI25M43RC3	F03FS07577
SCHELLING FH4 (from 07/2015 till 07/2017)	Fólap	360	4,4	3,2	30	72	TCG	15°	15°	2/13/94	LSB36003X	F03FS09341
	Elővágó	200	4,3-5,5	3,2	20	36	ATB	8°	15°	2/11/66 + 2/10/60 + 2/9/62	LI25M43PA3	F03FS02670
FH4 (from 07/2017)	Fólap	360	4,4	3,2	30	72	TCG	15°	15°	2/13/94	LSB36003X	F03FS09341
	Elővágó	300	4,3-5,5	3,2	30	48	ATB	12°	15°	2/11/73 + 2/11/75 + 2/13/94	LI25M43RC3	F03FS07577
FH5 (from 07/2015)	Fólap	400	4,4	3,2	30	72	TCG	15°	15°	2/10/60 + 2/13/94	LSB40007X	F03FS07725
	Elővágó	300	4,3-5,5	3,2	30	48	ATB	12°	15°	2/11/73 + 2/11/75 + 2/13/94	LI25M43RC3	F03FS07577

Géptípus	Laptípus	D	B-B1	b	d	Z	Fogtípus	α	β	ill. furatok	Freud kód	Cikksz.
		mm	mm	mm	mm							
FH5 (from 07/2015)	Fólap	400	4,4	3,2	30	72	TCG	15°	15°	2/10/60 + 2/13/94	LSB40007X	F03FS07725
	Elővágó	300	4,3-5,5	3,2	30	48	ATB	12°	15°	2/11/73 + 2/11/75 + 2/13/94	LI25M43RC3	F03FS07577
FH5	Fólap	400	4,4	3,2	30	72	TCG	15°	15°	2/10/60 + 2/13/94	LSB40007X	F03FS07725
	Elővágó	200	4,3-5,5	3,2	20	36	ATB	8°	15°	2/11/66 + 2/10/60 + 2/9/62	LI25M43PA3	F03FS02670
FK4 (from 07/2015)	Fólap	400	4,4	3,2	30	72	TCG	15°	15°	2/10/60 + 2/13/94	LSB40007X	F03FS07725
	Elővágó	200	4,3-5,5	3,2	20	36	ATB	8°	15°	2/11/66 + 2/10/60 + 2/9/62	LI25M43PA3	F03FS02670
FK4 (from 07/2017)	Fólap	400	4,4	3,2	30	72	TCG	15°	15°	2/10/60 + 2/13/94	LSB40007X	F03FS07725
	Elővágó	300	4,3-5,5	3,2	30	48	ATB	12°	15°	2/11/73 + 2/11/75 + 2/13/94	LI25M43RC3	F03FS07577
FH6, AH6, CH6 (till 06/2015)	Fólap	460	4,4	3,2	30	72	TCG	15°	15°	2/13/94	LSB46001X	F03FS08922
	Elővágó	200	4,3-5,5	3,2	20	36	ATB	8°	15°	2/11/66 + 2/10/60 + 2/9/62	LI25M43PA3	F03FS02670
FK6, FP6, FM6	Fólap	460	4,4	3,2	30	72	TCG	15°	15°	2/13/94	LSB46001X	F03FS08922
	Elővágó	200	4,3-5,5	3,2	20	36	ATB	8°	15°	2/11/66 + 2/10/60 + 2/9/62	LI25M43PA3	F03FS02670
FH6, AH6, CH6 (starting from 07/2015)	Fólap	480	4,8	3,5	30	72	TCG	15°	15°	2/10/60 + 2/13/94	LSB48004X	F03FS09187
	Elővágó	220	4,7-5,9	3,5	20	36	ATB	8°	15°	2/9/62	LI25M47UA3	F03FS09266
	Elővágó	200	4,7-5,9	3,5	20	36	ATB	8°	15°	2/11/66	LI25M47PA3	F03FS02716
FL	Fólap	480	4,4	3,2	30	72	TCG	15°	15°	2/10/60 + 2/13/94	LSB48007X	F03FS09914
	Elővágó	200	4,3-5,5	3,2	20	36	ATB	8°	15°	2/11/66 + 2/10/60 + 2/9/62	LI25M43PA3	F03FS02670
FH8, AH8, CH8	Fólap	520	4,8	3,5	30	72	TCG	15°	15°	2/13/94	LSB52007X	F03FS09319
	Fólap	520	4,4	3,2	30	72	TCG	15°	15°	2/13/94	LSB52008X	F03FS09319
	Elővágó	200	4,3-5,5	3,2	20	36	ATB	8°	15°	2/11/66 + 2/10/60 + 2/9/62	LI25M43PA3	F03FS02670
FK8, FM8	Elővágó	220	4,7-5,9	3,5	20	36	ATB	8°	15°	2/9/62	LI25M47UA3	F03FS09266
	Elővágó	200	4,7-5,9	3,5	20	36	ATB	8°	15°	2/11/66	LI25M47PA3	F03FS02716
	Fólap	520	4,8	3,5	30	72	TCG	15°	15°	2/13/94	LSB52007X	F03FS09319
FK10, FM10	Elővágó	200	4,7-5,9	3,5	20	36	ATB	8°	15°	2/11/66	LI25M47PA3	F03FS02716
	Fólap	520	4,4	3,2	30	72	TCG	15°	15°	2/13/94	LSB52008X	F03FS09319
	Elővágó	200	4,3-5,5	3,2	20	36	ATB	8°	15°	2/11/66 + 2/10/60 + 2/9/62	LI25M43PA3	F03FS02670
FK10, FM10	Fólap	680	6,2	4,2	40	60	TCG	18°	13°	2/13/140 + 2/17/140 + 2/13/114	LSB68001X	F03FS09203
	Elővágó	200	6,1-7,3	4	20	36	ATB	8°	15°	2/11/66	LI25M61PA3	F03FS02730
ASH (FSM)	Fólap	720	6,4	4,4	40	60	TCG	18°	13°	2/14/114 + 2/14/140	LSB72001X	F03FS09204
	Elővágó	220	6,3-7,5	4,4	20	36	ATB	8°	15°	2/11/66	LI25M63UA3	F03FS02732

Géptípus	Laptípus	D	B-B1	b	d	Z	Fogtípus	α	β	ill. furatok	Freud kód	Cikksz.
		mm	mm	mm	mm							
SCM												
PRIMA 50	Fólap	300	4,4	3	80	60	TCG	15°	15°	4/9/100 + 2/14/110	LSB30004X	F03FS09157
	Fólap	300	4,4	3	80	72	TCG	15°	15°	4/9/100 + 2/14/110	LSB30008X	F03FS07804
	Elővágó	160	4,3-5,5	3,2	55	36	ATB	8°	15°	3/6/84 + 3/7/66	LI25M43LG3	F03FS02657
PRIMA 67	Fólap	320	4,4	3,2	80	60	TCG	10°	15°	4/9/100 + 2/9/110 + 2/14/110	LSB32006X	F03FS10101
	Elővágó	160	4,3-5,5	3,2	55	36	ATB	8°	15°	3/6/84 + 3/7/66	LI25M43LG3	F03FS02657
	Utófor. elővágó	280	4,65	3,2	80	72	ATB	15°	15°	2/14/110	LI27M47VL3	F03FS08014
IMPACT 85 K	Fólap	350	4,4	3,2	80	72	TCG	15°	15°	4/9/100 + 2/9/110 + 2/14/110	LSB35005X	F03FS07635
	Elővágó	160	4,3-5,5	3,2	55	36	ATB	8°	15°	3/6/84 + 3/7/66	LI25M43LG3	F03FS02657
IMPACT 105 C/D, PLUS 105 C/D/P	Fólap	380	4,4	3,2	80	72	TCG	15°	15°	4/9/100 + 2/9/110 + 2/14/110	LSB38010X	F03FS07808
	Elővágó	160	4,3-5,5	3,2	55	36	ATB	8°	15°	3/6/84 + 3/7/66	LI25M43LG3	F03FS02657
IMPACT 90	Fólap	380	4,4	3,2	80	48	TCG	15°	15°	4/9/100 + 2/9/110 + 2/14/110	LSB38009X	F03FS09164
	Elővágó	160	4,3-5,5	3,2	55	36	ATB	8°	15°	3/6/84 + 3/7/66	LI25M43LG3	F03FS02657
	Elővágó	200	4,3-5,5	3,2	80	36	ATB	8°	15°	2/14/110	LI25M43PL3	F03FS02683
	Dia Elővágó	200	4,3-5,1	3,2	80	36	FLAT	6°	14°	2/14/110	DLI25M43PLH4	F03FS09627
	Dia Elővágó	200	4,3-5,1	3,2	80	36	FLAT	6°	14°	2/14/110	DLI25M43PLH6	F03FS09628
	Utófor. elővágó	300	4,7	3,2	80	72	ATB	15°	15°	2/14/110	LI27M DC3	F03FS02741
IMPACT 110	Fólap	400	4,4	3,2	80	72	TCG	15°	15°	4/9/100 + 2/9/110 + 2/14/110 + 2/14/125	LSB40012X	F03FS09173
	Elővágó	160	4,3-5,5	3,2	55	36	ATB	8°	15°	3/6/84 + 3/7/66	LI25M43LG3	F03FS02657
	Elővágó	200	4,3-5,5	3,2	80	36	ATB	8°	15°	2/14/110	LI25M43PL3	F03FS02683
	Dia Elővágó	200	4,3-5,1	3,2	80	36	FLAT	6°	14°	2/14/110	DLI25M43PLH4	F03FS09627
	Dia Elővágó	200	4,3-5,1	3,2	80	36	FLAT	6°	14°	2/14/110	DLI25M43PLH6	F03FS09628
	Utófor. elővágó	300	4,7	3,2	80	72	ATB	15°	15°	2/14/110	LI27M DC3	F03FS02741

Géptípus	Laptípus	D	B-B1	b	d	Z	Fogtípus	α	β	ill. furatok	Freud kód	Cikksz.
		mm	mm	mm	mm							
SCM-GABBIANI												
GALAXY 90	Fólap	300	4,4	3	80	60	TCG	15°	15°	4/9/100 + 2/14/110	LSB30004X	F03FS09157
	Fólap	300	4,4	3	80	72	TCG	15°	15°	4/9/100 + 2/14/110	LSB30008X	F03FS07804
	Elővágó	200	4,3-5,5	3,2	80	36	ATB	8°	15°	2/14/110	LI25M43PL3	F03FS02683
	Dia Elővágó	200	4,3-5,1	3,2	80	36	FLAT	6°	14°	2/14/110	DLI25M43PLH4	F03FS09627
	Dia Elővágó	200	4,3-5,1	3,2	80	36	FLAT	6°	14°	2/14/110	DLI25M43PLH6	F03FS09628
Utófor. elővágó	300	4,7	3,2	80	72	ATB	15°	15°	2/14/110	LI27M DC3	F03FS02741	
GALAXY 85	Fólap	350	4,4	3,2	80	72	TCG	15°	15°	4/9/100 + 2/9/110 + 2/14/110	LSB35005X	F03FS07635
	Elővágó	200	4,3-5,5	3,2	80	36	ATB	8°	15°	2/14/110	LI25M43PL3	F03FS02683
	Dia Elővágó	200	4,3-5,1	3,2	80	36	FLAT	6°	14°	2/14/110	DLI25M43PLH4	F03FS09627
	Dia Elővágó	200	4,3-5,1	3,2	80	36	FLAT	6°	14°	2/14/110	DLI25M43PLH6	F03FS09628
	Fólap	400	4,4	3,2	80	72	TCG	15°	15°	4/9/100 + 2/9/110 + 2/14/110 + 2/14/125	LSB40012X	F03FS09173
GALAXY3 110, 110A	Elővágó	200	4,3-5,5	3,2	80	36	ATB	8°	15°	2/14/110	LI25M43PL3	F03FS02683
	Dia Elővágó	200	4,3-5,1	3,2	80	36	FLAT	6°	14°	2/14/110	DLI25M43PLH4	F03FS09627
	Dia Elővágó	200	4,3-5,1	3,2	80	36	FLAT	6°	14°	2/14/110	DLI25M43PLH6	F03FS09628
	Utófor. elővágó	300	4,7	3,2	80	72	ATB	15°	15°	2/14/110	LI27M DC3	F03FS02741
	Fólap	400	4,4	3,2	80	72	TCG	15°	15°	4/9/100 + 2/9/110 + 2/14/110 + 2/14/125	LSB40012X	F03FS09173
GALAXY 115	Elővágó	200	4,3-5,5	3,2	80	36	ATB	8°	15°	2/14/110	LI25M43PL3	F03FS02683
	Dia Elővágó	200	4,3-5,1	3,2	80	36	FLAT	6°	14°	2/14/110	DLI25M43PLH4	F03FS09627
	Dia Elővágó	200	4,3-5,1	3,2	80	36	FLAT	6°	14°	2/14/110	DLI25M43PLH6	F03FS09628
	Fólap	430	4,4	3,2	80	72	TCG	15°	15°	2/9/130 + 2/14/110 + 4/19/120	LSB43009X	F03FS07909
GALAXY3 130, 130A	Elővágó	200	4,3-5,5	3,2	80	36	ATB	8°	15°	2/14/110	LI25M43PL3	F03FS02683
	Dia Elővágó	200	4,3-5,1	3,2	80	36	FLAT	6°	14°	2/14/110	DLI25M43PLH4	F03FS09627
	Dia Elővágó	200	4,3-5,1	3,2	80	36	FLAT	6°	14°	2/14/110	DLI25M43PLH6	F03FS09628
	Utófor. elővágó	300	4,7	3,2	80	72	ATB	15°	15°	2/14/110	LI27M DC3	F03FS02741
GALAXY3 145	Fólap	450	4,4	3,2	80	72	TCG	15°	15°	2/9/130 + 2/14/110 + 4/19/120	LSB45009X	F03FS07811
	Elővágó	200	4,3-5,5	3,2	80	36	ATB	8°	15°	2/14/110	LI25M43PL3	F03FS02683
	Dia Elővágó	200	4,3-5,1	3,2	80	36	FLAT	6°	14°	2/14/110	DLI25M43PLH4	F03FS09627
	Dia Elővágó	200	4,3-5,1	3,2	80	36	FLAT	6°	14°	2/14/110	DLI25M43PLH6	F03FS09628











Géptípus	Laptípus	D	B-B1	b	d	Z	Fogtípus	α	β	ill. furatok	Freud kód	Cikksz.
		mm	mm	mm	mm							
GALAXY 140, ELITE	Fólap	450	4,4	3,2	80	72	TCG	15°	15°	2/9/130 + 2/14/110 + 4/19/120	LSB45009X	F03FS07811
	Elővágó	200	4,3-5,5	3,2	80	36	ATB	8°	15°	2/14/110	LI25M43PL3	F03FS02683
	Dia Elővágó	200	4,3-5,1	3,2	80	36	FLAT	6°	14°	2/14/110	DLI25M43PLH4	F03FS09627
	Dia Elővágó	200	4,3-5,1	3,2	80	36	FLAT	6°	14°	2/14/110	DLI25M43PLH6	F03FS09628
GALAXY3	Fólap	460	4,4	3,2	80	72	TCG	15°	15°	2/14/110 + 4/9/100	LSB46003X	F03FS09950
	Elővágó	200	4,3-5,5	3,2	80	36	ATB	8°	15°	2/14/110	LI25M43PL3	F03FS02683
	Dia Elővágó	200	4,3-5,1	3,2	80	36	FLAT	6°	14°	2/14/110	DLI25M43PLH4	F03FS09627
	Dia Elővágó	200	4,3-5,1	3,2	80	36	FLAT	6°	14°	2/14/110	DLI25M43PLH6	F03FS09628
TÖRK MAKINE												
MP70R	Fólap	320	4,4	3,2	75	72	TCG	15°	15°	3/7/100 + 3/13/95	LSB32002X	F03FS09162
	Elővágó	160	4,3-5,5	3,2	55	36	ATB	8°	15°	3/6/84 + 3/7/66	LI25M43LG3	F03FS02657
TURANLAR												
T-PE 433	Fólap	300	4,4	3	30	60	TCG	15°	15°	2/10/60	LSB30001X	F03FS07802
	Fólap	300	4,4	3	30	72	TCG	15°	15°	2/10/60	LSB30005X	F03FS07803
	Elővágó	150	4,3-5,6	3,2	30	36	ATB	8°	15°	-	LI25M43KC3	F03FS02649
T-PE 434 (before 2020)	Fólap	400	4,4	3,2	80	72	TCG	15°	15°	4/9/100 + 2/9/110 + 2/14/110 + 2/14/125	LSB40012X	F03FS07810
	Elővágó	200	4,3-5,5	3,2	65	36	ATB	8°	15°	2/9/100 + 2/9/110	LI25M43PI3	F03FS02681
T-PE 434	Fólap	430	4,4	3,2	80	72	TCG	15°	15°	2/9/130 + 2/14/110 + 4/19/120	LSB43009X	F03FS07909
	Elővágó	200	4,3-5,5	3,2	65	36	ATB	8°	15°	2/9/100 + 2/9/110	LI25M43PI3	F03FS02681
T-PE 435	Fólap	430	4,4	3,2	80	72	TCG	15°	15°	2/9/130 + 2/14/110 + 4/19/120	LSB43009X	F03FS07909
	Elővágó	200	4,3-5,5	3,2	65	36	ATB	8°	15°	2/9/100 + 2/9/110	LI25M43PI3	F03FS02681
T-PE 436 (before 2020)	Fólap	450	4,8	3,5	80	72	TCG	15°	15°	2/14/125 + 2/9/130 + 4/19/120	LSB45018X	F03FS07812
	Elővágó	200	4,7-5,9	3,5	65	36	ATB	8°	15°	2/9/100 + 2/9/110	LI25M47PI3	F03FS02720































TALÁLJA MEG A TÖKÉLETES LAPSZABÁSZ FÜRÉSZLAPOT ÁTMÉRŐ SZERINT





























































LSB X teljes választék

























































D	B	b	d	Z	α	β	ill. furatok	Géptípus	Freud kód	Cikksz.
mm	mm	mm	mm							
250	4,2	3	30	60	15°	15°		SCM - Techmatic, Verry	 LSB25003X	F03FS10212
250	4,2	3	50	60	15°	15°		Usikraft	 LSB25005X	F03FS10214
250	4,2	3	55	60	15°	15°		Baldan, SCM - Techmatic	 LSB25002X	F03FS10211
250	4,4	3	30	80	15°	15°	2/9/46,4 + 2/10/60		 LSB25004X	F03FS10213
270	4,2	3	55	60	15°	15°		SCM - Techmatic	 LSB27001X	F03FS10215
280	4,4	3,2	55	60	15°	15°	2/10/70	Baldan	 LSB28001X	F03FS10216
290	4,2	3	55	60	15°	15°		SCM - Techmatic	 LSB29001X	F03FS10217
300	4,4	3	30	60	15°	15°	2/10/60	Panhans	 LSB30001X	F03FS07802
300	4,4	3	65	60	15°	15°	2/9/110	Selco	 LSB30002X	F03FS09159
300	4,4	3	75	60	15°	15°		Homag	 LSB30003X	F03FS10218
300	4,4	3	80	60	15°	15°	4/9/100 + 2/14/110	SCM	 LSB30004X	F03FS09157

D	B	b	d	Z	α	β	ill. furatok	Géptípus	Freud kód	Cikksz.
mm	mm	mm	mm							
300	4,4	3	30	72	15°	15°	2/10/60	Panhans, Verry	 LSB30005X	F03FS07803
300	4,4	3,2	60	72	15°	15°	2/14/100	Holzma	 LSB30012X	F03FS09207
300	4,4	3	65	72	15°	15°	2/9/95 + 2/9/110	Selco	 LSB30006X	F03FS09158
300	4,4	3	75	72	15	15°		Holzma	 LSB30007X	F03FS10219
300	4,4	3	80	72	15°	15°	4/9/100 + 2/14/110	SCM	 LSB30008X	F03FS07804
300	4,4	3	75	96	15°	15°			 LSB30010X	F03FS10220
305	4,4	3	30	60	15	15°	2/10/60	Mayer, Panhans, SCM	 LSB30501X	F03FS10221
310	4,4	3,2	60	72	15°	15°	2/14/100	Holzma	 LSB31001X	F03FS09949
320	4,4	3,2	30	60	15°	15°			 LSB32005X	F03FS09160
320	4,4	3,2	50	60	15	15°	3/15/80 + 3/13/95	Giben	 LSB32004X	F03FS10222
320	4,4	3,2	65	60	15°	15°	2/9/110	Selco	 LSB32003X	F03FS09161
320	4,4	3,2	80	60	10°	15°	4/9/100 + 2/9/110 + 2/14/110		 LSB32006X	F03FS10101
320	4,4	3,2	60	72	15	15	2/14/100		 LSB32008X	F03FS10268
320	4,4	3,2	65	72	15°	15°	2/9/110	Selco	 LSB32001X	F03FS07805
320	4,4	3,2	75	72	15°	15°	3/13/95 + 3/7/100	Giben	 LSB32002X	F03FS09162
320	4,4	3,2	80	72	15°	15°	4/9/100 + 2/9/110 + 2/14/110		 LSB32007X	F03FS10267
350	4,2	3,2	80	96	15°	15°			 LSB35011X	F03FS10225
350	4,4	3,2	30	54	15°	15°	2/10/60	Panhans, Scheer	 LSB35001X	F03FS10223
350	4,4	3,2	60	54	15°	15°	2/14/100	Holzma	 LSB35002X	F03FS10224
350	4,4	3,2	30	72	15°	15°	2/10/60	Panhans, Scheer	 LSB35003X	F03FS07630
350	4,4	3,2	50	72	15°	15°	4/13/80	Giben	 LSB35006X	F03FS07709
350	4,4	3,2	60	72	15°	15°	2/14/100	Holzma	 LSB35004X	F03FS07636
350	4,4	3,2	65	72	15°	15°	2/9/110	Selco	 LSB35013X	F03FS09659
350	4,4	3,2	75	72	15°	15°		Giben, Hansol Géptípus	 LSB35008X	F03FS07634
350	4,4	3,2	80	72	15°	15°	4/9/100 + 2/9/110 + 2/14/110	Gabbiani	 LSB35005X	F03FS07635
355	4,4	3,2	75	54	15°	15°		Giben	 LSB35502X	F03FS10226
355	4,4	3,2	80	54	15°	15°	4/9/100 + 2/9/110 + 2/14/110	Gabbiani	 LSB35503X	F03FS09205
355	4,4	3,2	30	72	15°	15°	2/10/60	Panhans, SCM	 LSB35504X	F03FS07674
355	4,4	3,2	65	72	15°	15°	2/9/95 + 2/9/110	Selco	 LSB35508X	F03FS08740
355	4,4	3,2	75	72	15°	15°	4/15/105 + 2/7/110	Giben, KDT, Hold	 LSB35505X	F03FS07633

D	B	b	d	Z	α	β	ill. furatok	Géptípus	Freud kód	Cikksz.
mm	mm	mm	mm							
355	4,4	3,2	75	72	15°	15°	3/7/100	Gabbiani	 LSB35507X	F03FS07710
355	4,4	3,2	80	72	15°	15°	4/9/100 + 2/9/110 + 2/14/110	Gabbiani	 LSB35506X	F03FS09163
360	4,4	3	65	60	15°	15°	2/9/110	Selco	 LSB36001X	F03FS10227
360	4,4	3,2	30	72	15°	15°	2/13/94	Schelling	 LSB36003X	F03FS09341
360	4,4	3,2	65	72	15°	15°	2/9/110	Selco	 LSB36002X	F03FS07673
370	4,4	3,2	30	72	15°	15°	2/10/60	Schelling	 LSB37001X	F03FS10228
380	4,4	3,2	80	48	15°	15°	4/9/100 + 2/9/110 + 2/14/110	Gabbiani	 LSB38009X	F03FS09164
380	4,4	3,2	50	60	15°	15°	4/13/80	Giben	 LSB38007X	F03FS10230
380	4,4	3,2	60	60	15°	15°	2/14/100	Holzma	 LSB38001X	F03FS07806
380	4,4	3,2	30	72	15°	15°	2/08/83		 LSB38011X	F03FS10231
380	4,4	3,2	50	72	15°	15°	4/13/80	Giben	 LSB38008X	F03FS09165
380	4,4	3,2	60	72	15°	15°	2/14/100	Holzma	 LSB38002X	F03FS07631
380	4,4	3,2	65	72	15°	15°	2/9/110	Selco	 LSB38014X	F03FS09166
380	4,4	3,2	75	72	15°	15°	2/14/100	Holzma, Wonpoong	 LSB38012X	F03FS07672
380	4,4	3,2	80	72	15°	15°	4/9/100 + 2/9/110 + 2/14/110	Gabbiani	 LSB38010X	F03FS07808
380	4,4	3,2	60	84	15°	15°	2/14/100	Holzma	 LSB38015X	F03FS08989
380	4,4	3,2	80	96	15°	15°	4/9/100 + 2/9/110 + 2/14/110	Gabbiani	 LSB38013X	F03FS07809
380	4,8	3,5	60	60	15°	15°	2/14/100	Holzma	 LSB38003X	F03FS10229
380	4,8	3,5	60	72	15°	15°	2/14/100	Holzma	 LSB38004X	F03FS07632
380	4,8	3,5	60	84	15°	15°	2/14/100	Holzma	 LSB38005X	F03FS07807
390	4,4	3,2	80	72	15°	15°	2/14/110	Sigma	 LSB39001X	F03FS09167
400	4,4	3,2	30	48	15°	15°			 LSB40001X	F03FS09168
400	4,4	3,2	80	48	15°	15°	2/9/110 + 4/9/100 + 2/14/110	Gabbiani	 LSB40010X	F03FS10233
400	4,4	3,2	30	60	15°	15°	2/10/60		 LSB40004X	F03FS09169
400	4,4	3,2	75	60	15°	15°	4/15/105	Giben	 LSB40005X	F03FS09170
400	4,4	3,2	80	60	15°	15°	2/9/130 + 4/19/120	Selco	 LSB40006X	F03FS10232
400	4,4	3,2	80	60	15°	15°	4/9/100 + 2/9/110 + 2/14/110	Gabbiani	 LSB40011X	F03FS09171
400	4,4	3,2	30	72	15°	15°	2/10/60 + 2/13/94	Scheer	 LSB40007X	F03FS07725
400	4,4	3,2	50,8	72	15°	15°	2/16/127 + 4/13/80		 LSB40018X	F03FS08957
400	4,4	3,2	60	72	15°	15°	2/11/85 + 2/14/100	Anthon	 LSB40017X	F03FS09272

D	B	b	d	Z	α	β	ill. furatok	Géptípus	Freud kód	Cikksz.	
mm	mm	mm	mm								
400	4,4	3,2	65	72	15°	15°	2/9/110	Selco		LSB40016X	F03FS09172
400	4,4	3,2	75	72	15°	15°	4/15/105 + 2/7/110 + 2/14/100	Giben, Haisung Woodworking Géptípusny, Hånsol Géptípus, HOMAG, Hyundai Sangi, KDT		LSB40008X	F03FS07726
400	4,4	3,2	80	72	15°	15°	2/15/105 + 2/9/130 + 4/19/120	Selco, MAS		LSB40009X	F03FS07810
400	4,4	3,2	80	72	15°	15°	4/9/100 + 2/9/110 + 2/14/110	Gabbiani		LSB40012X	F03FS09173
400	4,4	3,2	60	84	15°	15°	2/14/100	Nanxing		LSB40021X	F03FS09255
400	4,4	3,2	75	84	15°	15°	4/15/105 + 2/7/110	KDT		LSB40019X	F03FS08990
400	4,8	3,5	60	72	15°	15°	2/14/125	Holzma		LSB40013X	F03FS07711
420	4,4	3,2	80	60	15°	15°	4/9/100 + 2/9/110 + 2/14/110	Gabbiani		LSB42004X	F03FS10235
420	4,4	3,2	50	72	15°	15°	2/9/130 + 4/19/120	Selco		LSB42006X	F03FS09174
420	4,4	3,2	80	72	15°	15°	4/9/100 + 2/9/110 + 2/14/110	Gabbiani		LSB42005X	F03FS09175
420	4,8	3,5	60	60	15°	15°	2/14/125	Holzma		LSB42001X	F03FS10234
420	4,8	3,5	60	84	15°	15°	2/14/100 + 2/14/125	Holzma		LSB42002X	F03FS09176
430	4,4	3,2	30	48	15°	15°				LSB43001X	F03FS10236
430	4,4	3,2	75	48	15°	15°	4/15/105	Giben		LSB43002X	F03FS10237
430	4,4	3,2	30	60	15°	15°	2/10/60			LSB43004X	F03FS10238
430	4,4	3,2	75	60	15°	15°	4/15/105	Giben		LSB43005X	F03FS10239
430	4,4	3,2	80	60	15°	15°	2/9/130 + 2/14/110 + 4/19/120	Selco - Gabbiani		LSB43006X	F03FS10240
430	4,4	3,2	30	72	15°	15°				LSB43007X	F03FS09177
430	4,4	3,2	65	72	15°	15°	2/9/110	Selco		LSB43012X	F03FS09178
430	4,4	3,2	75	72	15°	15°	4/15/105 + 2/7/110	Giben		LSB43008X	F03FS07908
430	4,4	3,2	80	72	15°	15°	2/9/130 + 2/14/110 + 4/19/120	Selco, Gabbiani		LSB43009X	F03FS07909
430	4,4	3,2	75	96	15°	15°	4/15/105 + 2/7/110	Giben Prismatic		LSB43010X	F03FS09179
430	4,8	3,5	70	72	15°	15°	4/11/130	Selco		LSB43013X	F03FS09180
450	4,4	3,2	30	48	15°	15°	2/09/60	Mayer, Panhans, SCM		LSB45001X	F03FS10241
450	4,4	3,2	60	48	15°	15°	2/14/125	Holzma		LSB45002X	F03FS10242
450	4,4	3,2	30	60	15°	15°	2/10/60	Mayer, Panhans, SCM		LSB45004X	F03FS10243
450	4,4	3,2	60	60	15°	15°	2/14/125	Holzma		LSB45005X	F03FS10244
450	4,4	3,2	80	60	10°	15°	2/9/130 + 4/19/120 + 2/14/110	Selco - Gabbiani		LSB45006X	F03FS10245
450	4,4	3,2	30	72	15°	15°	2/10/60 + 2/14/95	Mayer, Panhans, SCM		LSB45007X	F03FS09181
450	4,4	3,2	60	72	15°	15°	2/14/125	Holzma		LSB45008X	F03FS09182

D	B	b	d	Z	α	β	ill. furatok	Géptípus	Freud kód	Cikksz.
mm	mm	mm	mm							
450	4,4	3,2	80	72	15°	15°	2/9/130 + 2/14/110 + 4/19/120	Selco, Gabbiani	 LSB45009X	F03FS07811
450	4,8	3,5	30	72	10°	15°	2/09/60	Scheer	 LSB45016X	F03FS10246
450	4,8	3,5	60	72	15°	15°	2/14/125 + 2/17/100	Holzma, Nanxing	 LSB45017X	F03FS07391
450	4,8	3,5	80	72	15°	15°	2/9/130 + 4/19/120	Selco	 LSB45018X	F03FS07812
450	4,8	3,5	60	84	10°	15°	2/14/125	Holzma	 LSB45019X	F03FS10247
460	4,4	3,2	30	72	15°	15°	2/13/94	Schelling	 LSB46001X	F03FS08922
460	4,4	3,2	75	72	15°	15°	2/7/110	Giben	 LSB46002X	F03FS07914
460	4,4	3,2	80	72	15°	15°	2/14/110 + 4/9/100	Gabbiani	 LSB46003X	F03FS09950
470	4,4	3,2	75	48	15°	15°	4/15/105	Giben	 LSB47001X	F03FS10248
470	4,4	3,2	75	60	15°	15°	4/15/105	Giben	 LSB47002X	F03FS10249
470	4,4	3,2	75	72	15°	15°	4/15/105	Giben, Hyundai Sangi	 LSB47003X	F03FS09183
470	4,4	3,2	75	96	15°	15°	4/15/105	Giben	 LSB47004X	F03FS09184
470	4,8	3,5	70	72	15°	15°	4/11/130	Selco	 LSB47005X	F03FS09185
480	4,4	3,2	30	72	15°	15°	2/10/60 + 2/13/94	Schelling	 LSB48007X	F03FS09914
480	4,8	3,5	80	60	15°	15°	2/9/130 + 4/19/120	Selco	 LSB48003X	F03FS09186
480	4,8	3,5	30	72	15°	15°	2/10/60 + 2/13/94	Schelling	 LSB48004X	F03FS09187
480	4,8	3,5	60	72	15°	15°	2/19/120		 LSB48006X	F03FS10269
480	4,8	3,5	80	72	15°	15°	2/9/130 + 4/19/120	Selco	 LSB48001X	F03FS09188
500	4,4	3,2	30	60	15°	15°		Schelling	 LSB50003X	F03FS10250
500	4,4	3,2	30	72	15°	15°		Schelling	 LSB50005X	F03FS10251
500	4,8	3,5	60	60	15°	15°	2/11/115	Holzma	 LSB50009X	F03FS09189
500	4,8	3,5	75	60	15°	15°	4/15/105	Giben	 LSB50010X	F03FS09190
500	4,8	3,5	60	72	15°	15°	2/11/115	Holzma	 LSB50011X	F03FS09191
510	4,8	3,5	80	72	15°	15°	2/9/130 + 4/19/120	Selco	 LSB51001X	F03FS09984
520	4,4	3,2	30	54	15°	15°	2/13/94	Schelling	 LSB52005X	F03FS10253
520	4,4	3,2	30	72	15°	15°	2/13/94	Schelling	 LSB52008X	F03FS09602
520	4,8	3,5	60	60	15°	15°	2/11/115 + 2/19/120	Holzma	 LSB52002X	F03FS10252
520	4,8	3,5	70	60	15°	15°	4/11/130		 LSB52009X	F03FS09958
520	4,8	3,5	30	72	15°	15°	2/13/94	Schelling	 LSB52007X	F03FS09319
520	4,8	3,5	60	72	15°	15°	2/11/115 + 2/19/120	Holzma	 LSB52003X	F03FS09192

D	B	b	d	Z	α	β	ill. furatok	Géptípus		Freud kód	Cikksz.
mm	mm	mm	mm	mm							
520	4,8	3,5	70	72	15°	15°	4/11/130	Selco		LSB52006X	F03FS09193
530	4,8	3,5	75	72	15°	15°	2/7/110	Giben		LSB53004X	F03FS09651
530	5,2	3,5	30	60	15°	15°		Schelling		LSB53001X	F03FS09194
530	5,2	3,5	100	60	15°	15°	2/7/140			LSB53003X	F03FS09195
530	5,8	4	60	60	15°	15°	1/11/85	Anthon		LSB53002X	F03FS10254
540	4,8	3,5	60	60	15°	15°	2/11/115 + 2/19/120	Holzma Typ 33		LSB54002X	F03FS10255
540	4,8	3,5	60	72	15°	15°	2/11/115 + 2/19/120	Holzma Typ 33		LSB54003X	F03FS10256
550	5	3,5	40	72	15°	15°	2/13/122	Schelling		LSB55007X	F03FS09216
550	5,2	3,5	80	48	15°	15°	2/14/110	Gabbiani		LSB55005X	F03FS10257
550	5,2	3,5	40	60	15°	15°	2/13/122			LSB55009X	F03FS09915
550	5,2	3,5	60	60	15°	15°				LSB55002X	F03FS09196
550	5,2	3,5	75	60	15°	15°	4/10,5/140			LSB55010X	F03FS10030
550	5,2	3,5	80	60	15°	15°	2/14/110	Gabbiani		LSB55006X	F03FS09197
550	5,2	3,5	90	60	15°	15°	4/10,5/140	Giben		LSB55008X	F03FS09970
565	5	3,5	100	72	15°	15°		Giben		LSB56504X	F03FS09215
565	5,2	3,5	100	60	15°	15°		Giben		LSB56502X	F03FS09198
570	4,8	3,5	60	60	15°	15°	2/11/115 + 2/19/120	Holzma		LSB57001X	F03FS09199
600	5,8	4	60	60	15°	15°	2/11/115 + 2/19/120	Holzma Typ 33		LSB60001X	F03FS09200
600	5,8	4	70	60	15°	15°	4/11/130			LSB60004X	F03FS10258
600	5,8	4	75	60	15°	15°	4/6,5/130 + 4/11/130	Selco		LSB60006X	F03FS10259
600	5,8	4	60	72	15°	15°	2/11/115 + 2/19/120	Holzma Typ 33		LSB60002X	F03FS09201
670	6,2	4,2	40	60	18°	13°	2/17/140 + 2/13/140	Schelling		LSB67003X	F03FS09202
670	6,2	4,2	40	72	15°	15°	2/17/140 + 2/13/140	Schelling		LSB67004X	F03FS10260
680	6,2	4,2	40	60	18°	13°	2/13/140 + 2/17/140 + 2/13/114	Schelling		LSB68001X	F03FS09203
720	6,4	4,4	40	60	18°	13°	2/14/114 + 2/14/140	Schelling		LSB72001X	F03FS09204

Precisely the best





Freud - iparági piacvezető 1962. óta

A Freud az egyik világelső a forgácsolószerszám iparágban és a prémium körfűrész tárcsák legnagyobb gyártója. A Freud 1962. óta tervezi és gyártja a kiváló minőségű körfűrész tárcsák, marófejek és forrasztottlapkás marók, fúrók, felsőmarók és CNC szerszámok, valamint tartozékok széles választékát.

Freud technológiák és megoldások Tökéletesen kialakítva az igényekre

A kiváló minőségű Freud vágószerszámok egyedülálló és innovatív tulajdonságokkal készülnek. A cég tulajdonolja és felügyeli az egész szerszámgyártási folyamatot, teljes körűen és szigorúan figyelve a minőségre, minden olaszországi gyárában. A folyamatos befektetések a Kutatás-Fejlesztésbe a Freud erős mérnöki kompetenciáival és a fejlett technológiákkal együtt eredményezik az innovatív tulajdonságú termékeket, a rendkívüli pontosságot és a hosszú él(et)tartamot. Mindig a jó megoldás felhasználói igényeikre.



Technológiai főlény Házon belüli vídiagyártás

1980. óta vezető a vídiagyártásban; a Freud büszke a világon egyedülálló házon belüli vídia komponens zsugorításra és gyártásra a kiváló minőségű vágószerszámokhoz. A Freud TiCo, egy speciálisan formulázott, magasan tömörített titán és kobalt karbid keverék, maximális pontosságot és hosszan tartó élességet biztosít a vágóéleknek. A dedikált receptúrák összeállításának képessége a standard és a testre szabott alkalmazásokhoz nyújtja a legnagyobb szerszámjeljesítményt.

Globális értékesítés Szerviz világszerte bárhol is legyen Ön

A Freud meggyőződése, a "gondolkodj globálisan és cselekedj helyben", a válogatott partnerek és leányvállalatok kiterjedt hálózatának fejlesztésére ösztönözte a céget a világ több mint 90 országában. Ez jobb támogatást jelent az ügyfeleknek, bárhol is legyenek.



freud

freud S.p.A.
Società Unipersonale
Via Remigio Solari, 7
33050 Pavia di Udine (UD) IT

www.freudtools.com



MKFRM 243 - F03FA24144 Printed in Italy - July 2023 - Rev. 0