

# freud

**Precisely  
the best**



## WIDE RANGE OF SUPERIOR QUALITY ROUTER BITS

Straight bits		Freud's straight router bits in all relevant shank diameters and with cutting diameters up to 25 mm. Designed to achieve clean and precise results in many applications.
Trimming bits		Freud's range of trimming router bits for precise trimming of laminate or veneered worktops. To work with jigs, to create or duplicate intricate shapes or for any task that requires a clean cut along a flush edge.
Edge forming bits		Freud's edge forming bits for profiling applications such as rounding, chamfering and many more.
Joinery bits		Freud's joinery router bits, from slotting cutters to dovetail router bits, designed to create perfect wood joints.
Surface forming bits		Freud's surface forming router bits for a perfect profile grooving on wood surfaces.
Mixed sets		Mixed router bit sets available in the most common shank diameters, along with our classical cabinet door sets.

### Icon guide

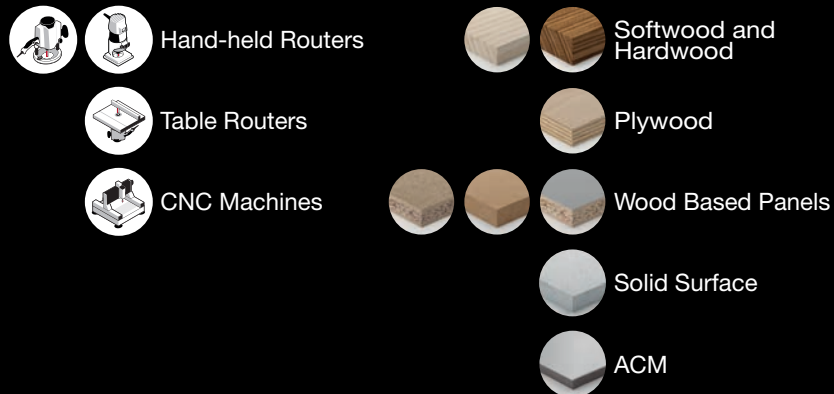

**Routing tools for hand-held routers,  
table routers and CNC machines**

# PRODUCT FEATURES

# WHY FREUD IS PRECISELY THE BEST



## Long lifetime

Customised teeth made of extra durable and hard Carbide grains, from in-house development and production.



## Shear Angle Technology

Carbide tip shear angles optimized to achieve outstanding performance and finish.



## TiCo Carbide

- A specially formulated, highly compact Titanium Cobalt Carbide, engineered and manufactured by freud.
- It provides a sharper edge and flawless finish with a dramatically longer cutting life.



## Perma-SHIELD Coating

- A non-stick coating formulation that withstands the toughest applications.
- It provides thermal insulation, protects from corrosion and eliminates resin build-up, reducing downtime for cleaning.



## Ball-bearing

High quality ball bearings are designed for high speeds. Protected against dust for an extra long lifetime..



## Coating Technology

Industry-first coating protects the router bit from friction, rust, resin build-up and corrosion for prolonged cutting life.

## Extreme shock resistance

Advanced brazing processes ensure the highest flexibility and impact resistance for each profile.



# FREUD KITCHEN FITTER SET

**ENSURING PERFECT WATERTIGHT WORKTOP JOINTS!**



- High quality straight bits ensure precise and watertight working joints. Perfect for kitchen worktops.
- Also used for grooving and other general routing applications.
- Flush trim bit for clean trim work on laminate worktops.
- The set includes two straight and a flush trim bit.
- TiCo carbide for sharper edges and longer lifetime.
- Perma-SHIELD coating reduces friction and resin build-up.

	Freud Code	Art. No.
Kitchen Fitter Router Bit Set	<b>88-20075P</b>	F03FR04370

**The set includes**

**DOUBLE FLUTE STRAIGHT BIT 12,7 x 50 x 98 mm**

Qty	A	Freud Code	Art. No.
2x	1/2"	<b>12-12850P</b>	F03FR01538

**FLUSH TRIM BIT 12,7 x 25 x 73 mm**

Qty	A	Freud Code	Art. No.
1x	1/4"	<b>42-10425P</b>	F03FR01940



## STRAIGHT BITS

### Double flute straight bits 04- 12- MM- R006M

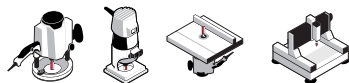

Type A - Solid Carbide bits

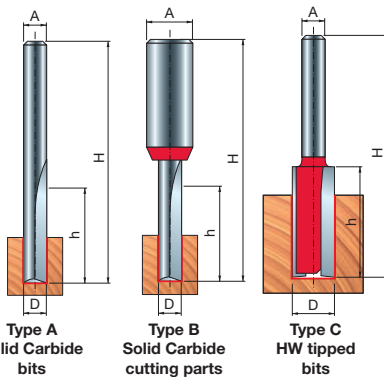

D	h	H	A	Z	Max RPM	Freud Code	Art. No.
mm	mm	mm	mm	inch	1/min.		
2	6,3	44,5	6	2	24.000	<b>04-09706P</b>	F03FR01413
3	9,5	44,5	6	2	24.000	<b>04-09906P</b>	F03FR01415
3	11	50,8	6	2	24.000	<b>04-10006P</b>	F03FR01418
3	12	50	6	2	24.000	<b>R006M03006</b>	F03FR01355
4	12	50,3	6	2	24.000	<b>R006M05006</b>	F03FR01356
4	12	50,8	6	2	24.000	<b>04-10206P</b>	F03FR01423
4	15,8	50,7	6	2	24.000	<b>04-10106P</b>	F03FR01420
5	12	50,3	6	2	24.000	<b>R006M07006</b>	F03FR01357
5	12,7	50,8	6	2	24.000	<b>04-11306P</b>	F03FR01437
5	16	51	6	2	24.000	<b>R006M07406</b>	F03FR01358



D	h	H	A	Z	Max RPM	Freud Code	Art. No.	
mm	mm	mm	mm	inch	1/min.			
6	16	50,8	6	2	24.000	04-11406P	F03FR01440	
6	16	57	6	2	24.000	R006M09406	F03FR01359	
6	25	63	6	2	24.000	R006M10206	F03FR01360	
6	25,4	76,2	6	2	24.000	04-11006P	F03FR01431	
3	9,5	44,5	8	2	24.000	04-09908P	F03FR01416	
4	15,8	50,7	8	2	24.000	04-10108P	F03FR01421	
5	12,7	50,8	8	2	24.000	04-11308P	F03FR01438	
6	16	50,8	8	2	24.000	04-11408P	F03FR01441	
6	25,4	76,2	8	2	24.000	04-11008P	F03FR01432	
1,58	6,4	44,5		1/4	2	24.000	04-09625P	F03FR01412
2	4	38,1		1/4	2	24.000	04-50225P	F03FR01502
2,38	9,5	38,1		1/4	2	24.000	04-09825P	F03FR01414
3	8	44,5		1/4	2	24.000	04-50825P	F03FR01503
3,18	9,5	44,5		1/4	2	24.000	04-10025P	F03FR01419
4	15,77	50,8		1/4	2	24.000	04-10125P	F03FR01422
4,76	12,7	49,2		1/4	2	24.000	04-10225P	F03FR01424
5	11,9	50,8		1/4	2	24.000	04-51225P	F03FR01504
6,35	12,7	50,5		1/4	2	24.000	04-10425P	F03FR01426
6,35	15,9	50,8		1/4	2	24.000	04-10525P	F03FR01427
6,35	19	57,1		1/4	2	24.000	04-10625P	F03FR01428
6,35	22,2	57,1		1/4	2	24.000	04-10725P	F03FR01429
6,35	25,4	63,5		1/4	2	24.000	04-10825P	F03FR01430
6,35	25,4	76,2		1/4	2	24.000	04-11025P	F03FR01433
6,35	19	61		1/2	2	24.000	12-10050P	F03FR01521
6,35	23	73		1/2	2	24.000	12-10250P	F03FR01522

## Type B - Solid Carbide cutting parts

D	h	H	A	Z	Max RPM	Freud Code	Art. No.
mm	mm	mm	mm		1/min.		
3	8	58	12	2	24.000	12-09612P	F03FR01517
4	10	58	12	2	24.000	12-09712P	F03FR01518
5	12,7	57	12	2	24.000	12-09812P	F03FR01519
6	19	64	12	2	24.000	12-09912P	F03FR01520

## Type C - HW tipped bits

D	h	H	A	Z	Max RPM	Freud Code	Art. No.
mm	mm	mm	mm	inch	1/min.		
7	25,4	63,5	6	2	24.000	04-11206P	F03FR01434
8	19,1	52	6	2	24.000	04-11506P	F03FR01443
8	31,8	70	6	2	24.000	04-11906P	F03FR01447
9	25	63	6	2	24.000	04-12406P	F03FR01450
10	25,4	62,4	6	2	24.000	MM-01006P	F03FR00330
10	31,8	69	6	2	24.000	MM-11006P	F03FR00333
11	25,4	62	6	2	24.000	04-13306P	F03FR01458
12	19	55,5	6	2	24.000	04-13506P	F03FR01460

D	h	H	A	Z	Max RPM	Freud Code	Art. No.
mm	mm	mm	mm	inch	1/min.		
12	31,8	68	6	2	24.000	04-13706P	F03FR01464
13	25,4	62,4	6	2	24.000	04-14206P	F03FR01470
14	19	56	6	2	24.000	04-14306P	F03FR01472
14	31,8	68,2	6	2	24.000	04-14506P	F03FR01475
15	20	57,2	6	2	24.000	04-14606P	F03FR01478
15	31,8	68,2	6	2	24.000	04-14706P	F03FR01480
16	19	51	6	2	24.000	04-14906P	F03FR01483
16	31,8	66	6	2	24.000	04-15006P	F03FR01486
18	20	52	6	2	24.000	04-15106P	F03FR01488
19	19	54	6	2	24.000	04-14006P	F03FR01468
20	19	56	6	2	24.000	04-15506P	F03FR01492
22	19	51	6	2	24.000	04-15706P	F03FR01495
24	20	52	6	2	24.000	04-15806P	F03FR01498
25	19	56	6	2	24.000	04-15906P	F03FR01500
7	25,4	63,5	8	2	24.000	04-11208P	F03FR01435
8	19	52	8	2	24.000	04-11508P	F03FR01444
8	31,8	70	8	2	24.000	04-11908P	F03FR01448
9	25	63	8	2	24.000	04-12408P	F03FR01451
10	25,4	62,4	8	2	24.000	MM-01008P	F03FR00331
10	31,8	69	8	2	24.000	MM-11008P	F03FR00334
12	19	55,5	8	2	24.000	04-13508P	F03FR01461
12	31,8	63,8	8	2	24.000	04-13708P	F03FR01465
14	19	56	8	2	24.000	04-14308P	F03FR01473
14	31,8	68,2	8	2	24.000	04-14508P	F03FR01476
15	20	57,2	8	2	24.000	04-14608P	F03FR01479
15	31,8	68,2	8	2	24.000	04-14708P	F03FR01481
16	19	51	8	2	24.000	04-14908P	F03FR01484
16	31,8	66	8	2	24.000	04-15008P	F03FR01487
18	20	52	8	2	24.000	04-15108P	F03FR01489
20	19	56	8	2	24.000	04-15508P	F03FR01493
22	19	51	8	2	24.000	04-15708P	F03FR01496
24	20	52	8	2	24.000	04-15808P	F03FR01499
25	19	56	8	2	24.000	04-15908P	F03FR01501
7	18	67	12	2	24.000	12-10312P	F03FR01523
8	31,8	76	12	2	24.000	12-10712P	F03FR01525
9	31,8	76	12	2	24.000	12-11012P	F03FR01528
10	31,8	76	12	2	24.000	12-11212P	F03FR01530
12	38,1	80	12	2	24.000	12-12212P	F03FR01534
12	50,5	98	12	2	24.000	12-12812P	F03FR01537
13	25,4	66,7	12	2	24.000	12-11612P	F03FR01531
14	31,8	73	12	2	24.000	12-13412P	F03FR01540
15	31,8	69,8	12	2	24.000	12-13512P	F03FR01541
16	38,1	76,1	12	2	24.000	12-14012P	F03FR01544
18	38,1	80	12	2	24.000	12-14312P	F03FR01547
19	25,4	63,4	12	2	24.000	12-15212P	F03FR01548
20	38,1	80	12	2	24.000	12-15912P	F03FR01553
22	38,1	80	12	2	24.000	12-16912P	F03FR01556
7,14	25,4	65,4		2	24.000	04-11225P	F03FR01436
7,94	25,4	71,4		2	24.000	04-11825P	F03FR01446
9,53	22,2	59,2		2	24.000	04-12025P	F03FR01449

D	h	H	A	Z	Max RPM	Freud Code	Art. No.	
mm	mm	mm	mm	inch	1/min.			
9,53	25,4	62,4		1/4	2	24.000	<b>04-12425P</b>	F03FR01452
9,53	31,8	68,7		1/4	2	24.000	<b>04-12625P</b>	F03FR01453
10	25,4	62,4		1/4	2	24.000	<b>MM-01025P</b>	F03FR00332
10	31,8	63,8		1/4	2	24.000	<b>04-52025P</b>	F03FR01505
11,11	25,4	62,4		1/4	2	24.000	<b>04-12925P</b>	F03FR01454
12	31,8	63,8		1/4	2	24.000	<b>04-52825P</b>	F03FR01506
12,7	19	55,5		1/4	2	24.000	<b>04-13025P</b>	F03FR01455
12,7	22,2	59,2		1/4	2	24.000	<b>04-13125P</b>	F03FR01456
12,7	25,4	62,4		1/4	2	24.000	<b>04-13225P</b>	F03FR01457
12,7	31,8	69,9		1/4	2	24.000	<b>04-13325P</b>	F03FR01459
15	31,8	66,7		1/4	2	24.000	<b>04-53625P</b>	F03FR01507
15,88	19	51		1/4	2	24.000	<b>04-13625P</b>	F03FR01463
15,88	31,8	69,9		1/4	2	24.000	<b>04-13725P</b>	F03FR01466
16	31,8	66,7		1/4	2	24.000	<b>04-54425P</b>	F03FR01508
17,46	19,1	56,1		1/4	2	24.000	<b>04-13825P</b>	F03FR01467
18	19,1	51,1		1/4	2	24.000	<b>04-54825P</b>	F03FR01509
19	19	57		1/4	2	24.000	<b>04-14025P</b>	F03FR01469
20	19,1	51,1		1/4	2	24.000	<b>04-55225P</b>	F03FR01510
22,23	19,1	56,1		1/4	2	24.000	<b>04-14825P</b>	F03FR01482
25,4	19,1	56,1		1/4	2	24.000	<b>04-15225P</b>	F03FR01491
7,94	25,4	78,9		1/2	2	24.000	<b>12-10650P</b>	F03FR01524
9,53	25,4	73,6		1/2	2	24.000	<b>12-10850P</b>	F03FR01526
9,53	31,8	82		1/2	2	24.000	<b>12-11050P</b>	F03FR01529
10	31,8	75		1/2	2	24.000	<b>12-52050P</b>	F03FR01558
12	31,8	75		1/2	2	24.000	<b>12-53050P</b>	F03FR01559
12,7	25,4	66,7		1/2	2	24.000	<b>12-11650P</b>	F03FR01532
12,7	31,8	77		1/2	2	24.000	<b>12-11850P</b>	F03FR01533
12,7	38,1	80,4		1/2	2	24.000	<b>12-12250P</b>	F03FR01535
12,7	38,1	108		1/2	2	24.000	<b>12-12450P</b>	F03FR01536
12,7	50,5	98		1/2	2	24.000	<b>12-12850P</b>	F03FR01538
12,7	63,2	110,7		1/2	2	24.000	<b>12-13050P</b>	F03FR01539
15,88	25,4	62,4		1/2	2	24.000	<b>12-13650P</b>	F03FR01542
15,88	31,8	71,8		1/2	2	24.000	<b>12-13850P</b>	F03FR01543
15,88	38,1	76,1		1/2	2	24.000	<b>12-14050P</b>	F03FR01545
15,88	50,8	103		1/2	2	24.000	<b>12-14250P</b>	F03FR01546
16	31,8	69,8		1/2	2	24.000	<b>12-54450P</b>	F03FR01560
19	25,4	63,4		1/2	2	24.000	<b>12-15250P</b>	F03FR01549
19	31,8	69,8		1/2	2	24.000	<b>12-15450P</b>	F03FR01550
19	38,1	76,1		1/2	2	24.000	<b>12-15650P</b>	F03FR01551
19,05	50,8	88,8		1/2	2	24.000	<b>12-15850P</b>	F03FR01552
20,63	31,8	76		1/2	2	24.000	<b>12-16250P</b>	F03FR01554
22,23	31,8	76		1/2	2	24.000	<b>12-16850P</b>	F03FR01555
25,4	31,8	69,8		1/2	2	24.000	<b>12-17250P</b>	F03FR01557

### Kitchen Fitter Set 88-

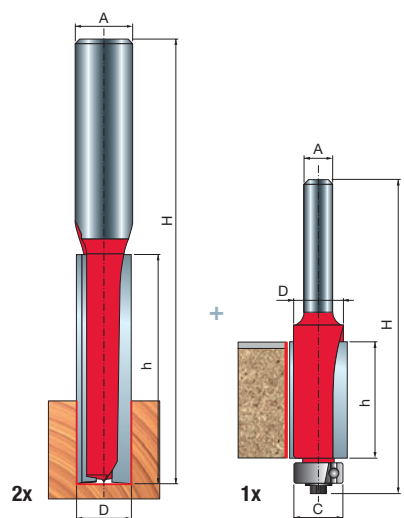
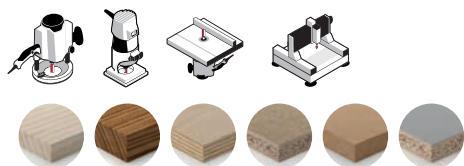

	A	Max RPM	Freud Code	Art. No.
	inch	1/min.		
2x Straight bit and 1x flush trim bit set	1/2 1/4	24.000	<b>88-20075P</b>	F03FR04370

### Double flute straight bits with bottom tip 17-

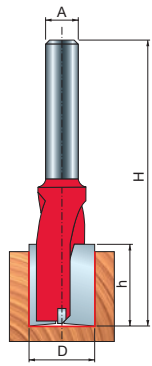
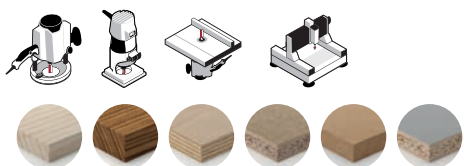

D	h	H	A	Z	Max RPM	Freud Code	Art. No.
mm	mm	mm	mm		1/min.		
16	45	85	8	2+1	24.000	<b>17-10008P</b>	F03FR01577
18	18	70	8	2+1	24.000	<b>17-10208P</b>	F03FR01578
20	18	70	8	2+1	24.000	<b>17-10408P</b>	F03FR01579
22	25	70	8	2+1	24.000	<b>17-10608P</b>	F03FR01580
16	60	110	12	2+1	24.000	<b>17-10112P</b>	F03FA13994



## Stagger bits

14-

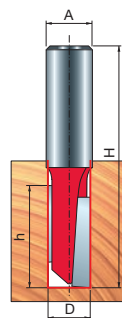
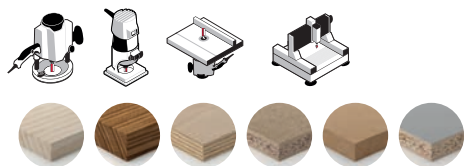

D	h	H	A	Z	Max RPM	Freud Code	Art. No.
mm	mm	mm	mm		1/min.		
9,53	37,8	82	12	2	24.000	<b>14-10212P</b>	F03FR01561
12,7	38,1	82	12	2	24.000	<b>14-10412P</b>	F03FR01562
12,7	37,8	79	12	2	24.000	<b>14-20412P</b>	F03FR01564
12,7	54	98,3	12	2	24.000	<b>14-10612P</b>	F03FR01563

## Mortising bits

16-

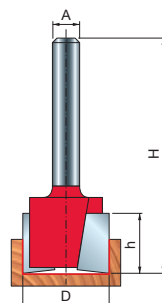
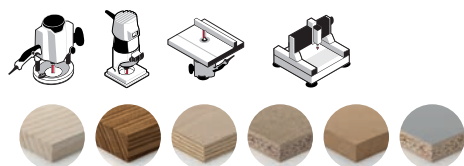

D	h	H	A	Z	Max RPM	Freud Code	Art. No.	
mm	mm	mm	mm	inch	1/min.			
12,7	12,5	51	6	2	24.000	<b>16-10006P</b>	F03FR01565	
19	12,5	51	6	2	24.000	<b>16-10406P</b>	F03FR01568	
19	19	62,15	6	2	24.000	<b>16-50406P</b>	F03FR01576	
12,7	12,5	50,8	8	2	24.000	<b>16-10008P</b>	F03FR01566	
19	12,5	50,8	8	2	24.000	<b>16-10408P</b>	F03FR01569	
12,7	12,5	60,5	12	2	24.000	<b>16-11012P</b>	F03FR01573	
31,75	12,1	56,2	12	2	24.000	<b>16-11812P</b>	F03FR01575	
12,7	12,5	51		1/4	2	24.000	<b>16-10025P</b>	F03FR01567
19	12,5	51		1/4	2	24.000	<b>16-10425P</b>	F03FR01570
12,7	12,5	60,5		1/2	2	24.000	<b>16-11050P</b>	F03FR01574
31,75	12,7	56,2		1/2	2	18.000	<b>16-10850P</b>	F03FR01572



## TRIMMING BITS

### Top bearing flush trim bits 50-

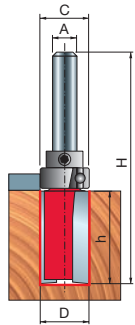

D	h	H	A	C	Z	Max RPM	Freud Code	Art. No.
mm	mm	mm	mm	inch	mm	1/min.		
13	20	60	6		13	24.000	<b>50-10206P</b>	F03FR02003
15	20	60	6		15	24.000	<b>50-10406P</b>	F03FR02006
19	25,4	67,5	6		19	24.000	<b>50-10606P</b>	F03FR02008
16	20	60	8		16	24.000	<b>50-10308P</b>	F03FR02005
22	20	60	8		22	24.000	<b>50-10808P</b>	F03FR02010
12,7	25,4	65,4		1/4	12,7	24.000	<b>50-10225P</b>	F03FR02004
15,88	25,4	65,4		1/4	15,88	24.000	<b>50-10425P</b>	F03FR02007
19	25,4	68,5		1/4	19	24.000	<b>50-10625P</b>	F03FR02009

## Flush trim bits 42- 44-

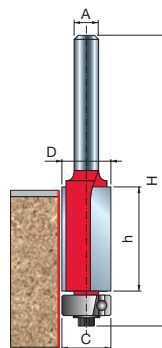

D	h	H	A	C	Z	Max RPM	Freud Code	Art. No.	
mm	mm	mm	mm	inch	mm	1/min.			
9,53	12,7	60,9	6		9,53	2	24.000	<b>42-10206P</b>	F03FR01935
9,53	25,8	72,4	6		9,53	2	24.000	<b>42-10006P</b>	F03FR01932
12,7	25,7	72,9	6		12,7	2	24.000	<b>42-10406P</b>	F03FR01938
9,53	12,7	60,9	8		9,53	2	24.000	<b>42-10208P</b>	F03FR01936
9,53	25,8	72,4	8		9,53	2	24.000	<b>42-10008P</b>	F03FR01933
12,7	25,7	72,9	8		12,7	2	24.000	<b>42-10408P</b>	F03FR01939
12,7	40	84	8		12,7	2	24.000	<b>42-11508P</b>	F03FR02771
12,7	25,4	82,5	12		12,7	2	24.000	<b>42-11012P</b>	F03FR01942
12,7	38,5	94,1	12		12,7	2	24.000	<b>42-11412P</b>	F03FR01944
12,7	50,8	106,8	12		12,7	2	24.000	<b>42-11612P</b>	F03FR01946
9,53	12,7	60,9		1/4	9,53	2	24.000	<b>42-10225P</b>	F03FR01937
9,53	25,8	72,4		1/4	9,53	2	24.000	<b>42-10025P</b>	F03FR01934
12,7	12,7	60,2		1/4	12,7	2	24.000	<b>42-10625P</b>	F03FR01941
12,7	25,7	72,9		1/4	12,7	2	24.000	<b>42-10425P</b>	F03FR01940
12,7	25,7	82,5		1/2	12,7	2	24.000	<b>42-11050P</b>	F03FR01943
12,7	38,5	94,1		1/2	12,7	2	24.000	<b>42-11450P</b>	F03FR01945
12,7	50,8	109,8		1/2	12,7	2	24.000	<b>42-11650P</b>	F03FR01947
12,7	38,5	94,1		1/2	12,7	3	24.000	<b>44-10850P</b>	F03FR01952



## Flush trim "V" groove bits 48-

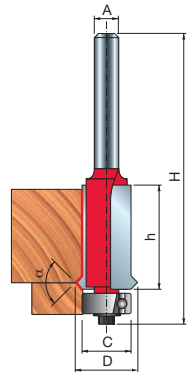

D	h	H	A	C	$\alpha$	Z	Max RPM	Freud Code	Art. No.
mm	mm	mm	mm	mm			1/min.		
15,88	25,4	76,2	6	12,7	90°	2	20.000	<b>48-10206P</b>	F03FR02000
15,88	25,4	76,2	8	12,7	90°	2	24.000	<b>48-10208P</b>	F03FR02001
15,88	25,4	87,2	12	12,7	90°	2	24.000	<b>48-11212P</b>	F03FR02002

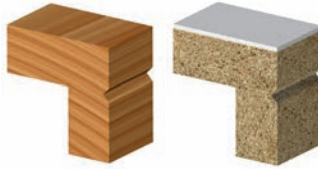

## Panel pilot bits 26- 28-

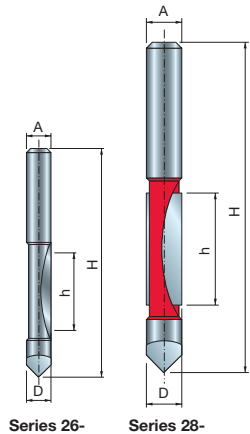
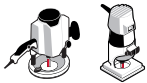

D	h	H	A	Z	Max RPM	Freud Code	Art. No.
mm	mm	mm	mm	inch	1/min.		
6	19	57	6	1	24.000	<b>26-10006P</b>	F03FR01664
8	19	75	8	1	24.000	<b>26-10008P</b>	F03FR01665
12,7	31,75	96,2	12	2	24.000	<b>28-10412P</b>	F03FR01692
6,35	19	57		1/4	24.000	<b>26-10025P</b>	F03FR01666
12,7	31,75	96,2		1/2	24.000	<b>28-10450P</b>	F03FR01693

- Solid Carbide Bits

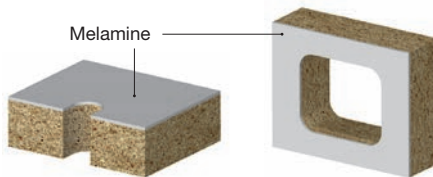



## EDGE FORMING BITS

### Rounding over bits 34- 36-

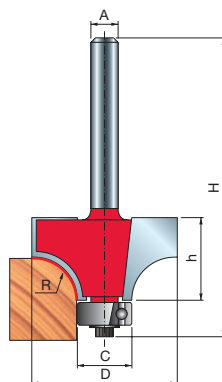

D	h	H	A	C	R	Z	Max RPM	Freud Code	Art. No.
mm	mm	mm	mm	inch	mm	mm	1/min.		
15,88	12,7	54,9	6	12,7	1,59	2	24.000	<b>34-10006P</b>	F03FR01763
16,7	12,7	54,9	6	12,7	2	2	24.000	<b>34-10106P</b>	F03FR02766
19,05	12,7	55,2	6	12,7	3,18	2	24.000	<b>34-10406P</b>	F03FR01768
22,22	12,7	54,9	6	12,7	4,8	2	24.000	<b>34-10806P</b>	F03FR01771
25,4	12,7	54,7	6	9,53	6,35	2	24.000	<b>36-11006P</b>	F03FR01803
25,4	12,7	55,2	6	12,7	6,35	2	24.000	<b>34-11006P</b>	F03FR01774
28,58	12,7	55,2	6	12,7	8	2	18.000	<b>34-11206P</b>	F03FR01777
31,75	18	59,7	6	12,7	9,53	2	18.000	<b>34-11406P</b>	F03FR01780
31,75	18	59,2	6	9,53	9,53	2	18.000	<b>36-11406P</b>	F03FR01804
38,1	19,1	61,25	6	12,7	12,7	2	16.000	<b>34-11606P</b>	F03FR01783



D	h	H	A	C	R	Z	Max RPM	Freud Code	Art. No.	
mm	mm	mm	mm	inch	mm	mm	1/min.			
15,88	12,7	54,9	8		12,7	1,59	2	24.000	<b>34-10008P</b>	F03FR01764
16,7	12,7	54,9	8		12,7	2	2	24.000	<b>34-10108P</b>	F03FR01766
18,7	12,7	54,9	8		12,7	3	2	24.000	<b>34-10308P</b>	F03FR01767
19,05	12,7	55,2	8		12,7	3,18	2	24.000	<b>34-10408P</b>	F03FR01769
22,22	13,2	54,9	8		12,7	4,75	2	24.000	<b>34-10808P</b>	F03FR01772
25,4	12,7	55,2	8		12,7	6,35	2	24.000	<b>34-11008P</b>	F03FR01775
28,58	12,7	55,2	8		12,7	7,94	2	18.000	<b>34-11208P</b>	F03FR01778
31,75	18	59,7	8		12,7	9,5	2	18.000	<b>34-11408P</b>	F03FR01781
38,1	19,1	61,25	8		12,7	12,7	2	16.000	<b>34-11608P</b>	F03FR01784
44,44	22,2	64,72	8		12,7	15,8	2	16.000	<b>34-12008P</b>	F03FR01793
25,4	12,7	61,2	12		12,7	6,35	2	24.000	<b>34-12012P</b>	F03FR01786
31,75	18	65,7	12		12,7	9,53	2	18.000	<b>34-12412P</b>	F03FR01788
38,1	19,05	67,25	12		12,7	12,7	2	16.000	<b>34-12612P</b>	F03FR01791
44,44	22,22	70,72	12		12,7	15,8	2	16.000	<b>34-12712P</b>	F03FR01794
50,8	25,4	73,9	12		12,7	19	2	16.000	<b>34-12812P</b>	F03FR01796
57,15	31,4	79,85	12		12,7	22,2	2	16.000	<b>34-13012P</b>	F03FR01798
63,5	31,3	79,75	12		12,7	25,4	2	12.000	<b>34-13212P</b>	F03FR01799
69,85	34,9	83,3	12		12,7	28,6	2	12.000	<b>34-13412P</b>	F03FR01801
76,2	38,1	86,6	12		12,7	31,8	2	12.000	<b>34-13612P</b>	F03FR01802
15,88	12,7	54,9		1/4	12,7	1,59	2	24.000	<b>34-10025P</b>	F03FR01765
19,05	12,7	55,2		1/4	12,7	3,18	2	24.000	<b>34-10425P</b>	F03FR01770
22,22	13,2	54,9		1/4	12,7	4,25	2	24.000	<b>34-10825P</b>	F03FR01773
25,4	12,7	55,2		1/4	12,7	6,35	2	24.000	<b>34-11025P</b>	F03FR01776
28,58	12,7	55,2		1/4	12,7	7,94	2	18.000	<b>34-11225P</b>	F03FR01779
31,75	18	59,7		1/4	12,7	9,53	2	18.000	<b>34-11425P</b>	F03FR01782
38,1	19,1	61,25		1/4	12,7	12,7	2	16.000	<b>34-11625P</b>	F03FR01785
25,4	12,7	61,2		1/2	12,7	6,35	2	24.000	<b>34-12050P</b>	F03FR01787
31,75	18	65,7		1/2	12,7	9,53	2	18.000	<b>34-12450P</b>	F03FR01790
38,1	19,1	67,25		1/2	12,7	12,7	2	16.000	<b>34-12650P</b>	F03FR01792
44,44	22,2	70,7		1/2	12,7	15,87	2	16.000	<b>34-12750P</b>	F03FR01795
50,8	25,4	73,9		1/2	12,7	19,05	2	16.000	<b>34-12850P</b>	F03FR01797
63,5	31,25	79,8		1/2	12,7	25,4	2	12.000	<b>34-13250P</b>	F03FR01800

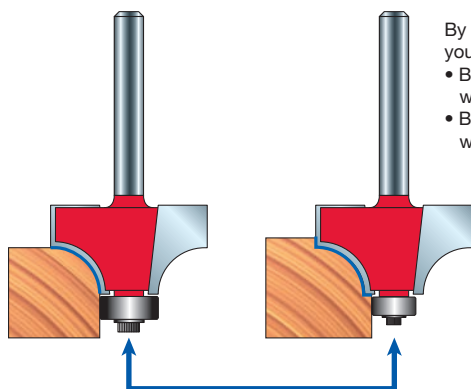

By ordering a smaller ball bearing and step washer you will be able to obtain a different profile:

- Ball bearing **3102M AA9** (Ø 9,53 mm) and Step washer **FX07M AA9** for series 34-
- Ball bearing **3102M AB9** (Ø 12,7 mm) and Step washer **FX07M AB9** for series 36-

## Chamfer bits

40-

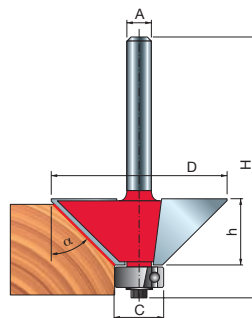
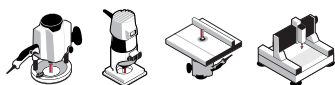

D	h	H	A	C	α	Z	Max RPM	Freud Code	Art. No.
mm	mm	mm	mm	inch	mm		1/min.		
18,15	12,7	54,9	6	12,7	15°	2	24.000	<b>40-10006P</b>	F03FR01906
21,77	25	67,3	6	12,7	11.3°	2	24.000	<b>40-09406P</b>	F03FR01900
23,6	12,7	54,9	6	12,7	25°	2	24.000	<b>40-10206P</b>	F03FR01912
24	12	44	6	•	30°	2	24.000	<b>40-90206P</b>	F03FR01929
24	14	46	6	•	15°	2	24.000	<b>40-90006P</b>	F03FR01927
25	8	40,3	6	•	45°	2	24.000	<b>40-90406P</b>	F03FR01931
25,4	25,1	67,25	6	12,7	15°	2	24.000	<b>40-09806P</b>	F03FR01903
30,1	22,5	64,7	6	12,7	22.5°	2	18.000	<b>40-10106P</b>	F03FR01909
31	9,5	52,3	6	12,7	45°	2	18.000	<b>40-10506P</b>	F03FR01917
33	11,5	54	6	12,7	45°	2	16.000	<b>40-10406P</b>	F03FR01914
33	19	61,6	6	12,7	30°	2	16.000	<b>40-20206P</b>	F03FR01925
44	18,5	61	6	12,7	45°	2	16.000	<b>40-10606P</b>	F03FR01919
18,15	12,7	54,9	8	12,7	15°	2	24.000	<b>40-10008P</b>	F03FR01907
21,77	25	67,3	8	12,7	11.3°	2	24.000	<b>40-09408P</b>	F03FR01901
23,6	12,7	54,9	8	12,7	25°	2	24.000	<b>40-10208P</b>	F03FR01913
24	12	44	8	•	30°	2	24.000	<b>40-90208P</b>	F03FR01930
24	14	46	8	•	15°	2	24.000	<b>40-90008P</b>	F03FR01928
25	8	40,3	8	•	45°	2	24.000	<b>40-90408P</b>	F03FR03255
25,4	25,1	67,25	8	12,7	15°	2	24.000	<b>40-09808P</b>	F03FR01904
30,1	22,5	64,7	8	12,7	22.5°	2	18.000	<b>40-10108P</b>	F03FR01910
31	9,5	52,3	8	12,7	45°	2	18.000	<b>40-10508P</b>	F03FR01918
33	11,5	54	8	12,7	45°	2	16.000	<b>40-10408P</b>	F03FR01915
33	19	61,6	8	12,7	30°	2	16.000	<b>40-20208P</b>	F03FR01926
44	18,5	61	8	12,7	45°	2	16.000	<b>40-10608P</b>	F03FR01920
21,77	25	73,3	12	12,7	11.3°	2	24.000	<b>40-09412P</b>	F03FR01902
25,4	25,1	73,25	12	12,7	15°	2	24.000	<b>40-09812P</b>	F03FR01905
30,1	22,5	70,7	12	12,7	22.5°	2	18.000	<b>40-10112P</b>	F03FR01911
44	18,5	67	12	12,7	45°	2	16.000	<b>40-11412P</b>	F03FR01922
62,1	25,5	74	12	12,7	45°	2	12.000	<b>40-11812P</b>	F03FR01924
18,15	12,7	54,9	1/4	12,7	15°	2	24.000	<b>40-10025P</b>	F03FR01908
33	11,5	53,9	1/4	12,7	45°	2	24.000	<b>40-10425P</b>	F03FR01916
41,5	15,9	58,4	1/4	12,7	45°	2	16.000	<b>40-10625P</b>	F03FR01921
43	18,5	67	1/2	12,7	45°	2	16.000	<b>40-11450P</b>	F03FR01923

- Without ball bearing.

## Cove bits 30-

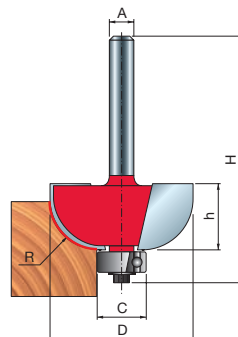

D	h	H	A	C	R	Z	Max RPM	Freud Code	Art. No.
mm	mm	mm	mm	inch	mm	mm	1/min.		
19,05	14	56	6	9,53	4,76	2	24.000	<b>30-10006P</b>	F03FR01694
22,23	13,2	54,7	6	9,53	6,35	2	24.000	<b>30-10206P</b>	F03FR01697
25,4	12,7	54,7	6	9,53	8	2	24.000	<b>30-10306P</b>	F03FR01700
31,75	12,7	55,2	6	12,7	9,53	2	18.000	<b>30-10406P</b>	F03FR01703
38,1	16,4	58,9	6	12,7	12,7	2	16.000	<b>30-10606P</b>	F03FR01706
19,05	14	56	8	9,53	4,75	2	24.000	<b>30-10008P</b>	F03FR01695
22,23	13,2	54,7	8	9,53	6,35	2	24.000	<b>30-10208P</b>	F03FR01698
25,4	12,7	54,7	8	9,53	8	2	24.000	<b>30-10308P</b>	F03FR01701
31,75	12,7	55,2	8	12,7	9,53	2	18.000	<b>30-10408P</b>	F03FR01704
38,1	16,4	58,9	8	12,7	12,7	2	16.000	<b>30-10608P</b>	F03FR01707
19,05	14	62,4	12	9,53	4,75	2	24.000	<b>30-10012P</b>	F03FR01696
22,23	12,7	60,7	12	9,53	6,35	2	24.000	<b>30-11012P</b>	F03FR01709
25,4	12,7	60,7	12	9,53	8	2	24.000	<b>30-11112P</b>	F03FR01710
31,75	12,7	61,2	12	12,7	9,5	2	18.000	<b>30-11212P</b>	F03FR01711
38,1	16,4	64,9	12	12,7	12,7	2	16.000	<b>30-11412P</b>	F03FR01713
22,23	13,2	54,7	1/4	9,53	6,35	2	24.000	<b>30-10225P</b>	F03FR01699
25,4	12,7	54,7	1/4	9,53	7,94	2	24.000	<b>30-10325P</b>	F03FR01702
31,75	12,7	55,2	1/4	12,7	9,5	2	18.000	<b>30-10425P</b>	F03FR01705
38,1	16,4	58,9	1/4	12,7	12,7	2	16.000	<b>30-10625P</b>	F03FR01708
31,75	12,7	61,2	1/2	12,7	9,53	2	18.000	<b>30-11250P</b>	F03FR01712
38,1	16,4	64,9	1/2	12,7	12,7	2	16.000	<b>30-11450P</b>	F03FR01714

## Classical cove bits 30-

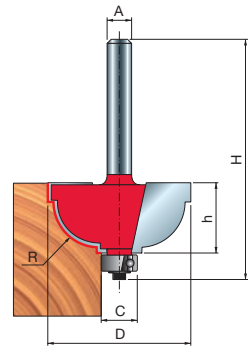

D	h	H	A	C	R	Z	Max RPM	Freud Code	Art. No.
mm	mm	mm	mm	mm	mm		1/min.		
28,58	13	54,2	6	9,53	4,8	2	18.000	<b>30-30406P</b>	F03FR01719
31,75	15,1	56,8	6	9,53	4,8	2	18.000	<b>30-20206P</b>	F03FR01715
28,58	13	54,2	8	9,53	4,8	2	18.000	<b>30-30408P</b>	F03FR01720
31,75	15,1	56,8	8	9,53	8	2	18.000	<b>30-20208P</b>	F03FR01716
28,58	13	60,2	12	9,53	4,8	2	18.000	<b>30-32412P</b>	F03FR01722
31,75	15,1	62,8	12	9,53	8	2	18.000	<b>30-22212P</b>	F03FR01718

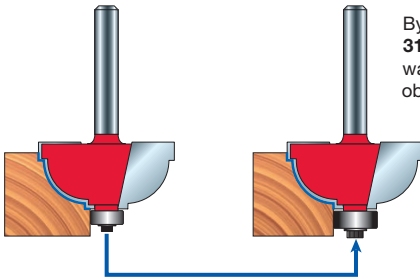

By simply ordering the Ball bearing **3102M AB9** (Ø 12,7 mm) and the Step washer **FX07M AB9** it is possible to obtain a different profile.

## Ogee fillet bits 38- 99-

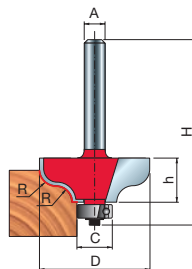

D	h	H	A	C	R	Z	Max RPM	Freud Code	Art. No.	
mm	mm	mm	mm	inch	mm	mm	1/min.			
31,75	12,2	53,9	6		9,53	4,8	2	18.000	<b>38-20206P</b>	F03FR01815
38,1	16,2	57,4	6		9,53	6,35	2	16.000	<b>38-20406P</b>	F03FR01818
31,75	12,2	53,9	8		9,53	4,8	2	18.000	<b>38-20208P</b>	F03FR01816
38,1	16,2	57,4	8		9,53	6,35	2	16.000	<b>38-20408P</b>	F03FR01819
31,75	12,2	59,9	12		9,53	4,8	2	18.000	<b>38-21212P</b>	F03FR01821
38,1	16,2	63,4	12		9,53	6,35	2	16.000	<b>38-21412P</b>	F03FR01822
31,75	12,2	53,9		1/4	9,53	4,76	2	18.000	<b>38-20225P</b>	F03FR01817
31,75	12,2	54,4		1/4	12,7	4,76	2	18.000	<b>38-15225P</b>	F03FR01814
38,1	16,2	57,4		1/4	9,53	6,35	2	16.000	<b>38-20425P</b>	F03FR01820
38,1	16,5	64,7		1/2	12,7	8,25	2	16.000	<b>99-00650P</b>	F03FR02412

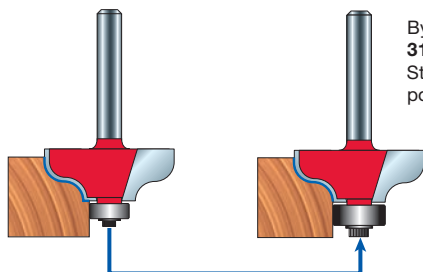

By simply ordering the Ball bearing **3102M AB9** (Ø 12,7 mm) and the Step washer **FX07M AB9** it is possible to obtain a different profile.



## Roman ogee bits

38-

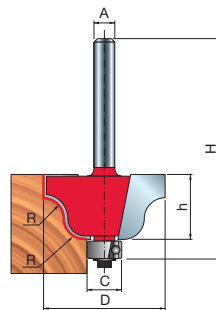

D	h	H	A	C	R	Z	Max RPM	Freud Code	Art. No.
mm	mm	mm	mm	inch	mm	mm	1/min.		
27	13,3	55,3	6	9,53	4	2	18.000	<b>38-1006P</b>	F03FR01805
35	18,5	60,5	6	9,53	6,35	2	16.000	<b>38-10206P</b>	F03FR01808
27	13,3	55,3	8	9,53	4	2	18.000	<b>38-10008P</b>	F03FR01806
35	18,5	60,5	8	9,53	6,35	2	16.000	<b>38-10208P</b>	F03FR01809
27	13,3	61,31	12	9,53	4	2	18.000	<b>38-10412P</b>	F03FR01811
35	18,5	66,5	12	9,53	6,35	2	16.000	<b>38-10612P</b>	F03FR01812
27	13,3	55,3	1/4	9,53	4	2	18.000	<b>38-10025P</b>	F03FR01807
35	18,5	66,5	1/4	9,53	6,35	2	16.000	<b>38-10225P</b>	F03FR01810
35	18,5	66,5	1/2	9,53	6,35	2	16.000	<b>38-10650P</b>	F03FR01813

## Classical roman ogee bits

38- 99-

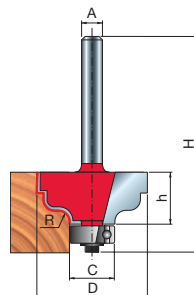

D	h	H	A	C	R	Z	Max RPM	Freud Code	Art. No.
mm	mm	mm	mm	inch	mm	mm	1/min.		
31,75	15	56,7	6	12,7	3,18	2	18.000	<b>38-40206P</b>	F03FR01832
31,75	15	56,7	8	12,7	3,18	2	18.000	<b>38-40208P</b>	F03FR01833
34,92	14,3	62,8	12	12,7	4,8	2	16.000	<b>99-00512P</b>	F03FR02411
31,75	15	56,7	1/4	12,7	3,18	2	18.000	<b>38-40225P</b>	F03FR01834

## Classical ogee bits 38- 99-

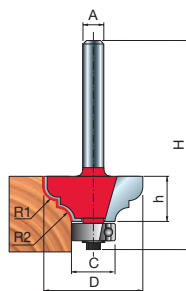

D	h	H	A	C	R1	R2	Z	Max RPM	Freud Code	Art. No.
mm	mm	mm	mm	inch	mm	mm	mm	1/min.		
28,58	12,7	54,9	6	12,7	4	4	2	18.000	<b>38-60206P</b>	F03FR01838
34,92	18,3	60	6	12,7	6,35	4,76	2	16.000	<b>38-60406P</b>	F03FR01841
28,58	12,7	54,9	8	12,7	4	4	2	18.000	<b>38-60208P</b>	F03FR01839
34,92	18,3	60	8	12,7	6,35	4,76	2	16.000	<b>38-60408P</b>	F03FR01842
28,58	12,7	61,2	12	12,7	4	4	2	18.000	<b>38-61212P</b>	F03FR01843
34,92	17,5	65,7	12	12,7	6,35	4,76	2	16.000	<b>38-61412P</b>	F03FR01844
28,58	12,7	54,9	1/4	12,7	3,97	3,97	2	18.000	<b>99-60225P</b>	F03FR01840
34,93	14,7	62,4	1/2	9,53	5,35	5,35	2	16.000	<b>99-00950P</b>	F03FR02415
34,92	17,5	65,7	1/2	12,7	6,35	4,76	2	16.000	<b>38-61450P</b>	F03FR01845

## Table top classical bold bits 99-

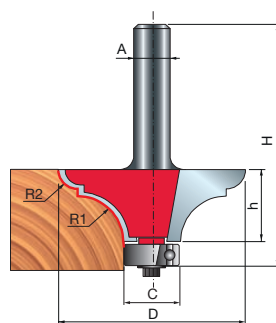

D	h	H	A	C	R1	R2	Z	Max RPM	Freud Code	Art. No.
mm	mm	mm	mm	mm	mm	mm	mm	1/min.		
41,3	15,9	58,4	8	12,7	10	4,3	2	16.000	<b>99-01108P</b>	F03FR02416
41,3	15,9	64,4	12	12,7	10	4,3	2	16.000	<b>99-01112P</b>	F03FR02417

## Double bead bits 38-

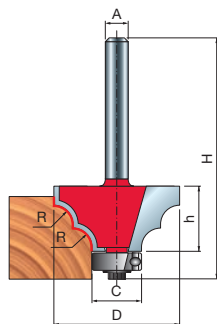

D	h	H	A	C	R	Z	Max RPM	Freud Code	Art. No.
mm	mm	mm	mm	mm	mm		1/min.		
32,7	15	57,2	6	12,7	5	2	16.000	<b>38-90006P</b>	F03FR01852
32,7	15	57,2	8	12,7	5	2	16.000	<b>38-90008P</b>	F03FR01853

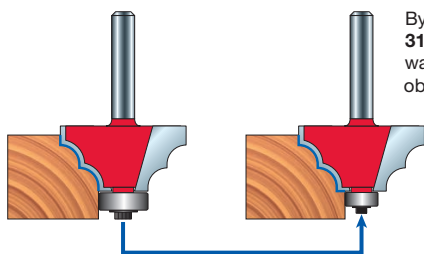

By simply ordering the Ball bearing **3102M AA9** (Ø 9,53 mm) and the Step washer **FX07M AA9** it is possible to obtain a different profile.

## Double cove bits 38-

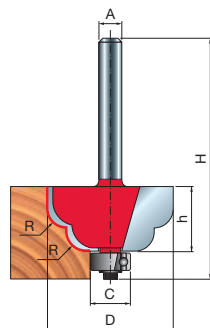

D	h	H	A	C	R	Z	Max RPM	Freud Code	Art. No.
mm	mm	mm	mm	mm	mm		1/min.		
32,7	15	57,2	6	12,7	5	2	16.000	<b>38-95006P</b>	F03FR01854
32,7	15	57,2	8	12,7	5	2	16.000	<b>38-95008P</b>	F03FR01855

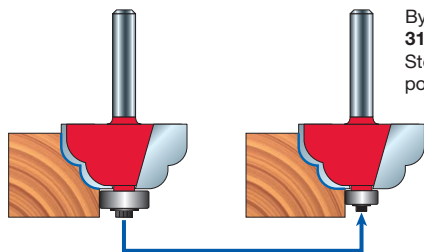

By simply ordering the Ball bearing **3102M AA9** (Ø 9,53 mm) and the Step washer **FX07M AA9** it is possible to obtain a different profile.

## Cove and bead bits 38-

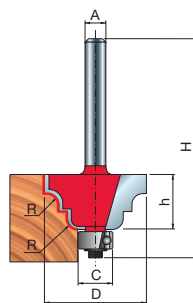

D	h	H	A	C	R	Z	Max RPM	Freud Code	Art. No.	
mm	mm	mm	mm	inch	mm	mm	1/min.			
29,38	13,5	55,5	6		9,53	3,97	2	18.000	<b>38-30606P</b>	F03FR01826
38,9	18,3	60	6		9,53	6,35	2	16.000	<b>38-30406P</b>	F03FR01823
29,38	13,5	55,5	8		9,53	3,97	2	18.000	<b>38-30608P</b>	F03FR01827
38,9	18,3	60	8		9,53	6,35	2	16.000	<b>38-30408P</b>	F03FR01824
29,38	13,5	61,2	12		9,53	3,97	2	18.000	<b>38-31212P</b>	F03FR01829
38,92	18,3	66	12		9,53	6,35	2	16.000	<b>38-31412P</b>	F03FR01831
38,9	18,3	60,8	1/4		9,53	6,35	2	16.000	<b>38-30425P</b>	F03FR01825

## Fillet cove and bead bits 38-

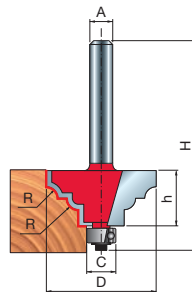

D	h	H	A	C	R	Z	Max RPM	Freud Code	Art. No.
mm	mm	mm	mm	mm	mm		1/min.		
32,7	14,5	56,7	6	12,7	3	2	16.000	<b>38-80006P</b>	F03FR01846
36,7	16,5	58,7	6	12,7	4	2	16.000	<b>38-80206P</b>	F03FR01848
40,7	18	60,2	6	12,7	5	2	16.000	<b>38-80406P</b>	F03FR01850
32,7	14,5	56,7	8	12,7	3	2	16.000	<b>38-80008P</b>	F03FR01847
36,7	16,5	58,7	8	12,7	4	2	16.000	<b>38-80208P</b>	F03FR01849
40,7	18	60,2	8	12,7	5	2	16.000	<b>38-80408P</b>	F03FR01851

## Double fillet ogee bits

38-

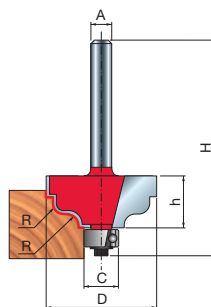

D	h	H	A	C	R	Z	Max RPM	Freud Code	Art. No.
mm	mm	mm	mm	inch	mm	mm	1/min.		
31,75	15	56,2	6	9,53	3,18	2	18.000	<b>38-45206P</b>	F03FR01835
31,75	15	56,2	8	9,53	3,18	2	18.000	<b>38-45208P</b>	F03FR01836
31,75	15	56,2	1/4	9,53	3,18	2	18.000	<b>38-45225P</b>	F03FR01837

## Traditional beading bits

80-

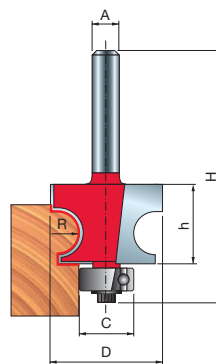

D	h	H	A	C	R	Z	Max RPM	Freud Code	Art. No.
mm	mm	mm	mm	mm	mm		1/min.		
22,23	14,3	56,9	6	12,7	3,18	2	24.000	<b>80-10206P</b>	F03FR02192
25,4	17,5	60	6	12,7	4,76	2	24.000	<b>80-10406P</b>	F03FR02195
30,17	22,2	64,2	6	12,7	7,14	2	18.000	<b>80-10806P</b>	F03FR02198
22,23	14,3	57,1	8	12,7	3,18	2	24.000	<b>80-10208P</b>	F03FR02193
25,4	17,5	60	8	12,7	4,76	2	24.000	<b>80-10408P</b>	F03FR02196
30,17	22,2	64,2	8	12,7	7,14	2	18.000	<b>80-10808P</b>	F03FR02199
22,23	14,3	62,9	12	12,7	3,18	2	24.000	<b>80-12212P</b>	F03FR02201
25,4	17,5	66,4	12	12,7	4,76	2	24.000	<b>80-12412P</b>	F03FR02203
30,17	22,2	70,6	12	12,7	7,14	2	18.000	<b>80-12812P</b>	F03FR02204



Profiling example



## Triple beading bits 80-

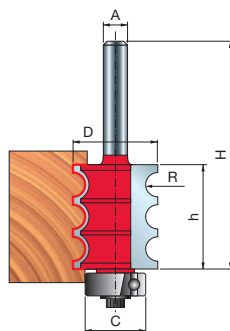

D	h	H	A	C	R	Z	Max RPM	Freud Code	Art. No.
mm	mm	mm	mm	mm	mm		1/min.		
22,24	27,4	70,9	6	15,88	3,18	2	18.000	<b>80-55206P</b>	F03FR02205
22,24	27,4	70,9	8	15,88	3,18	2	24.000	<b>80-55208P</b>	F03FR02206
22,24	27,4	76,9	12	15,88	3,18	2	24.000	<b>80-57212P</b>	F03FR02207

## Triple fluting bits 84-

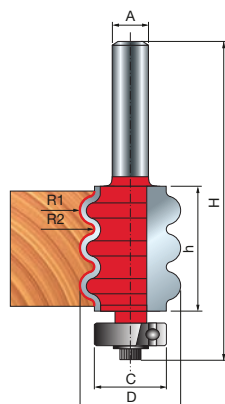

D	h	H	A	C	R1	R2	Z	Max RPM	Freud Code	Art. No.
mm	mm	mm	mm	mm	mm	mm		1/min.		
22,24	27,4	70,9	6	15,88	3,18	1,16	2	24.000	<b>84-10606P</b>	F03FR02220
22,24	27,4	70,9	8	15,88	3,18	1,16	2	24.000	<b>84-10608P</b>	F03FR02221
22,24	27,4	76,9	12	15,88	3,18	1,16	2	24.000	<b>84-12612P</b>	F03FR02222

# Top bearing ogee and cove moulding bits

23-



## Type A

D	h	H	A	C	R	Z	Max RPM	Freud Code	Art. No.
mm	mm	mm	mm	mm	mm		1/min.		
39,5	11,5	54,6	8	19	4	2	16.000	<b>23-10008P</b>	F03FR01654
39,5	11,5	58	12	19	4	2	16.000	<b>23-10012P</b>	F03FR01655
54	11,5	58	12	19	4	2	16.000	<b>23-10212P</b>	F03FR01656
60,5	17,3	63,8	12	19	6,35	2	12.000	<b>23-10412P</b>	F03FR01657

## Type B

D	h	H	A	C	R	Z	Max RPM	Freud Code	Art. No.
mm	mm	mm	mm	mm	mm		1/min.		
38	12,5	55,6	8	19	6,35	2	16.000	<b>23-20008P</b>	F03FR01658
38	12,5	59	12	19	6,35	2	16.000	<b>23-20012P</b>	F03FR01659

## Type C

D	h	H	A	C	R	Z	Max RPM	Freud Code	Art. No.
mm	mm	mm	mm	mm	mm		1/min.		
35	13,2	56,3	8	19	8	2	16.000	<b>23-20208P</b>	F03FR01660
38	14,5	57,6	8	19	9,53	2	16.000	<b>23-20408P</b>	F03FR01662
35	13,2	59,7	12	19	8	2	16.000	<b>23-20212P</b>	F03FR01661
38	14,5	61	12	19	9,53	2	16.000	<b>23-20412P</b>	F03FR01663

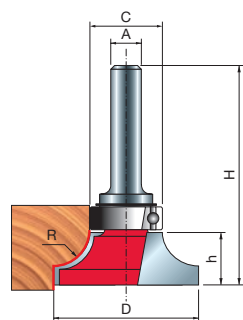
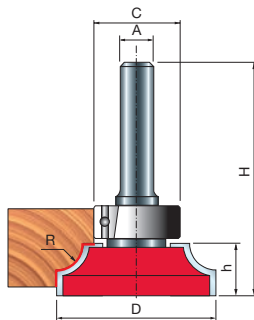
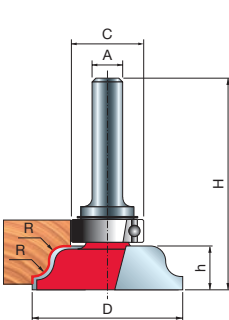

# Table edge and hand rail bits

99-



## Type A

D	h	H	A	C	R1	R2	$\alpha$	Z	Max RPM	Freud Code	Art. No.
mm	mm	mm	mm	mm	mm	mm			1/min.		
63,5	18	66,2	12	12,7	30	8	15°	2	12.000	<b>99-02712P</b>	F03FR02421

## Type B

D	h	H	A	C	R	$\alpha$	Z	Max RPM	Freud Code	Art. No.
mm	mm	mm	mm	mm	mm			1/min.		
35	38,5	86,6	12	12,7	3,18	25°	2	16.000	<b>99-07212P</b>	F03FR02456

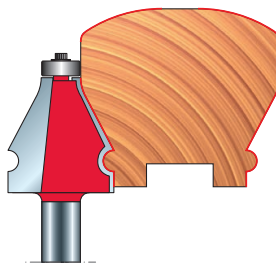
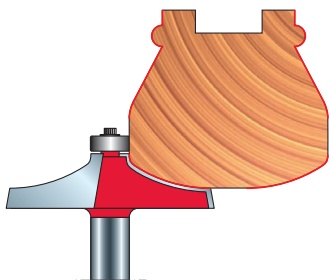
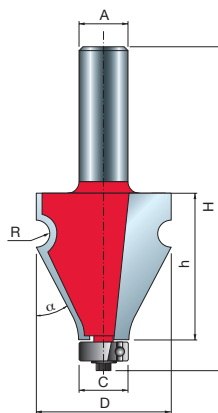
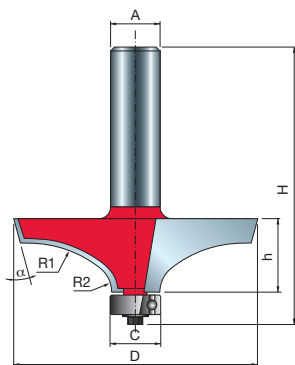

## Half round bits 82-

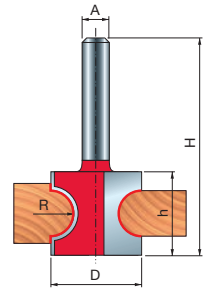
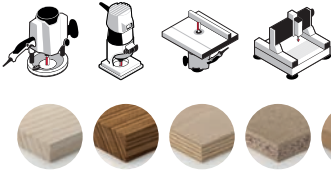

D	h	H	A	R	Z	Max RPM	Freud Code	Art. No.	
mm	mm	mm	mm	inch	mm	1/min.			
19	12,4	44,4	6	3,18	2	24.000	<b>82-10206P</b>	F03FR02208	
22,22	19,5	51,5	6	4,8	2	24.000	<b>82-10406P</b>	F03FR02210	
25,4	22,9	54,9	6	6,35	2	24.000	<b>82-10606P</b>	F03FR02213	
19	12,4	44,4	8	3,18	2	24.000	<b>82-10208P</b>	F03FR02209	
22,22	19,5	51,5	8	4,76	2	24.000	<b>82-10408P</b>	F03FR02211	
25,4	22,9	54,9	8	6,35	2	24.000	<b>82-10608P</b>	F03FR02214	
19	12,4	53,4	12	3,2	2	24.000	<b>82-11012P</b>	F03FR02215	
22,22	19,5	60,5	12	4,76	2	24.000	<b>82-11212P</b>	F03FR02216	
25,4	22,9	64,9	12	6,35	2	24.000	<b>82-11412P</b>	F03FR02217	
37	29,05	71,05	12	9,5	2	16.000	<b>82-11612P</b>	F03FR02218	
45,9	35,4	73,4	12	12,7	2	16.000	<b>82-11812P</b>	F03FR02219	
22	19,5	51,5		1/4	4,76	2	24.000	<b>82-10425P</b>	F03FR02212

# Multi-profile bits

99-



D	h	H	A	C	R1	R2	R2	Z	Max RPM	Freud Code	Art. No.
mm	mm	mm	mm	mm	mm	mm	mm		1/min.		
54,7	49	102	12	12,7	6	8	10	2	10.000	<b>99-PK112P</b>	F03FR02406
31,75	20	58	12	-	2,4	9,53	-	2	18.000	<b>99-PK212P</b>	F03FR02408
31,75	23,8	72	12	12,7	3,2	9,53	2,4	2	18.000	<b>99-PK312P</b>	F03FR02409
44,44	29	77,1	12	12,7	3	10,5	7	2	16.000	<b>99-00812P</b>	F03FR02414
23,8	35	83,5	12	12,7	4	15	-	2	24.000	<b>99-01212P</b>	F03FR02418
23,8	35	83,5	12	12,7	3,5	4,5	8,5	2	24.000	<b>99-01312P</b>	F03FR02419

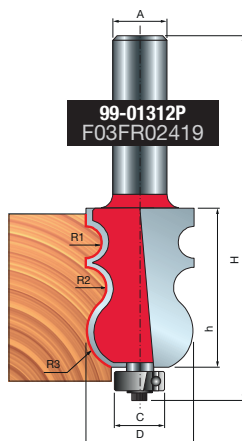
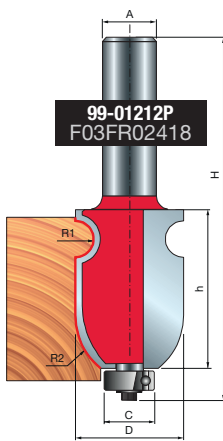
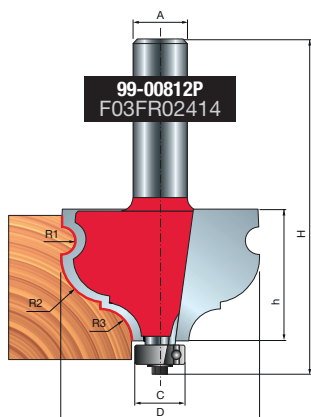
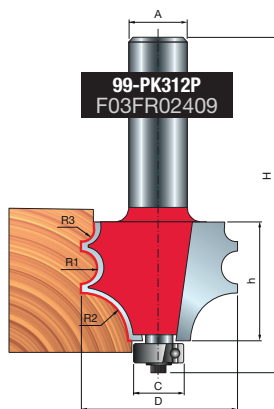
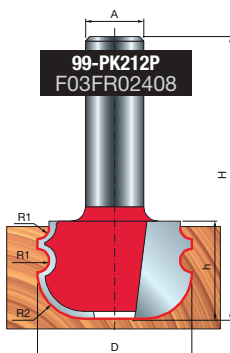
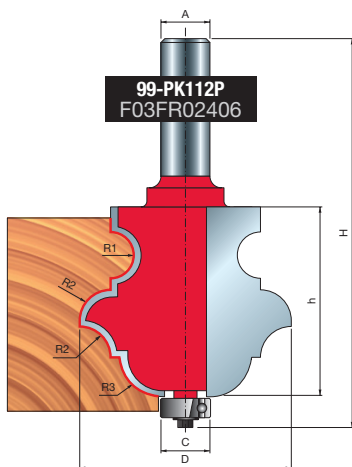

## Round over bowl bits 85-

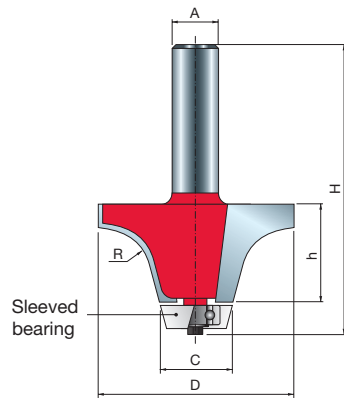

D	h	H	A	C	R	Z	Max RPM	Freud Code	Art. No.	
mm	mm	mm	mm	inch	mm	mm	1/min.			
54	25,4	74,6	12		22,2	12,7	2	16.000	<b>85-00112P</b>	F03FR02223
57,2	31,8	81	12		22,2	12,7	2	12.000	<b>85-00312P</b>	F03FR02225
50,8	25,4	73,6		1/2	19,1	12,7	2	16.000	<b>85-00150P</b>	F03FR02224

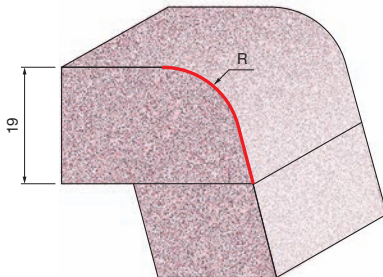
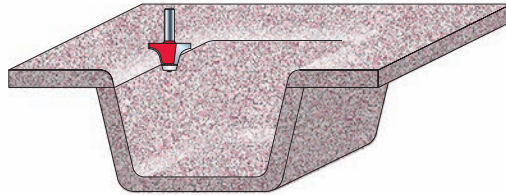

**85-00112P**  
F03FR02223

**85-00150P**  
F03FR02224

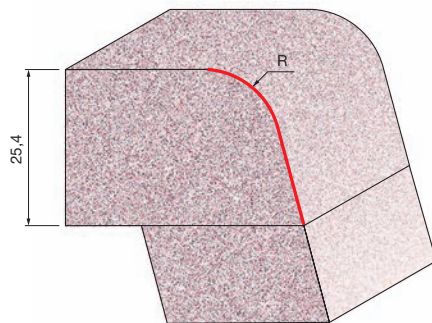

**85-00312P**  
F03FR02225

## Ogee bowl bits 85-

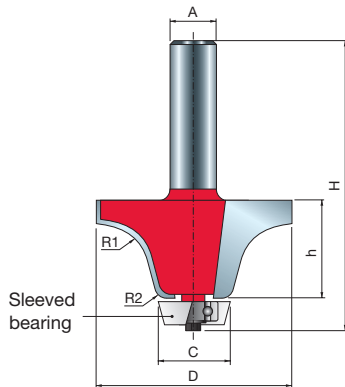

D	h	H	A	C	R1	R2	Z	Max RPM	Freud Code	Art. No.
mm	mm	mm	mm	mm	mm	mm		1/min.		
54	25,4	74,6	12	19,2	12,7	6,35	2	16.000	<b>85-00512P</b>	F03FR02226
57,2	31,8	80,9	12	19,2	12,7	6,35	2	12.000	<b>85-00712P</b>	F03FR02227

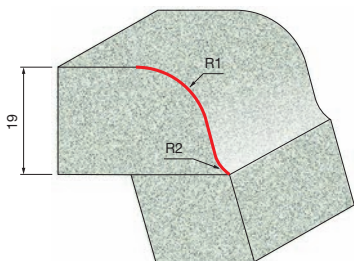
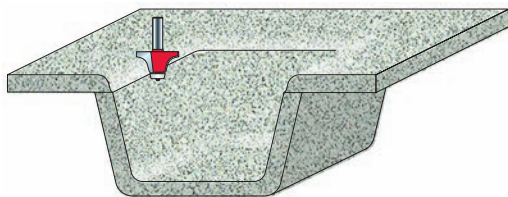

**85-00512P**  
F03FR02226

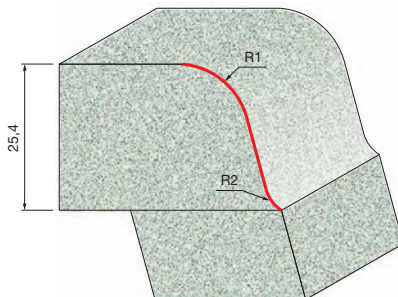

**85-00712P**  
F03FR02227



## Bevel bowl bit 85-

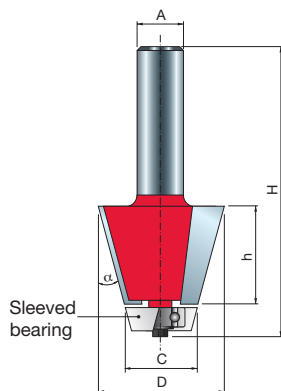

D	h	H	A	C	α	Z	Max RPM	Freud Code	Art. No.
mm	mm	mm	mm	mm			1/min.		
35,6	25,4	78,1	12	22,2	15°	2	16.000	<b>85-00912P</b>	F03FR02228

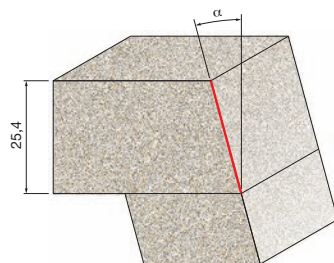
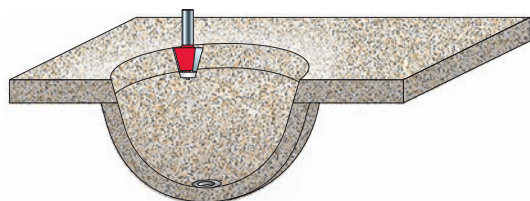

## Wavy joint bit 85-

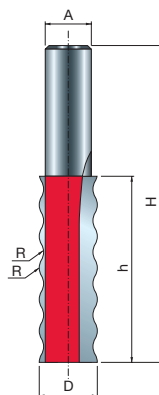
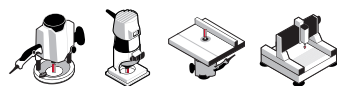

D	h	H	A	α	Z	Max RPM	Freud Code	Art. No.
mm	mm	mm	mm			1/min.		
16	51,3	88	12	4	2	24.000	<b>85-03312P</b>	F03FR02229

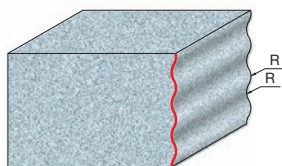



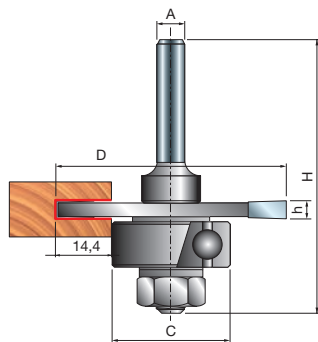

## JOINERY BITS

### Wing slotting cutters 63-



D	h	H	A	C	Z	Max RPM	Freud Code	Art. No.
mm	mm	mm	mm	mm		1/min.		
50,8	1,5	60,3	6	22	3	24.000	<b>63-09906P</b>	F03FR02049
50,8	1,6	60,3	6	22	3	24.000	<b>63-10006P</b>	F03FR02055
50,8	2	60,3	6	22	3	24.000	<b>63-10406P</b>	F03FR02058
50,8	2,4	60,3	6	22	3	24.000	<b>63-10606P</b>	F03FR02061
50,8	2,5	60,3	6	22	3	24.000	<b>63-11306P</b>	F03FR02079
50,8	3	60,3	6	22	3	24.000	<b>63-11406P</b>	F03FR02085
50,8	3,2	60,3	6	22	3	24.000	<b>63-10806P</b>	F03FR02064
50,8	3,5	60,3	6	22	3	24.000	<b>63-11506P</b>	F03FR02091
50,8	4	60,3	6	22	3	24.000	<b>63-10906P</b>	F03FR02067
50,8	4,8	60,3	6	22	3	24.000	<b>63-11006P</b>	F03FR02070
50,8	5	60,3	6	22	3	24.000	<b>63-11606P</b>	F03FR02097
50,8	6	60,3	6	22	3	24.000	<b>63-11106P</b>	F03FR02073

D	h	H	A	C	Z	Max RPM	Freud Code	Art. No.
mm	mm	mm	mm	mm		1/min.		
50,8	6,4	60,3	6	22	3	24.000	<b>63-11206P</b>	F03FR02076
50,8	1,5	60,3	8	22	3	24.000	<b>63-09908P</b>	F03FR02052
50,8	2,5	60,3	8	22	3	24.000	<b>63-11308P</b>	F03FR02082
50,8	3	60,3	8	22	3	24.000	<b>63-11408P</b>	F03FR02088
50,8	3,5	60,3	8	22	3	24.000	<b>63-11508P</b>	F03FR02094
50,8	5	60,3	8	22	3	24.000	<b>63-11608P</b>	F03FR02100
50,8	1,5	60,3	12	22	3	24.000	<b>63-14912P</b>	F03FR02105
50,8	1,6	60,3	12	22	3	24.000	<b>63-15012P</b>	F03FR02108
50,8	2	60,3	12	22	3	24.000	<b>63-15412P</b>	F03FR02111
50,8	2,4	60,3	12	22	3	24.000	<b>63-15612P</b>	F03FR02114
50,8	2,5	60,3	12	22	3	24.000	<b>63-16312P</b>	F03FR02132
50,8	3	60,3	12	22	3	24.000	<b>63-16412P</b>	F03FR03241
50,8	3,2	60,3	12	22	3	24.000	<b>63-15812P</b>	F03FR02117
50,8	3,5	60,3	12	22	3	24.000	<b>63-16512P</b>	F03FR02137
50,8	4	60,3	12	22	3	24.000	<b>63-15912P</b>	F03FR02120
50,8	4,8	60,3	12	22	3	24.000	<b>63-16012P</b>	F03FR02123
50,8	5	60,3	12	22	3	24.000	<b>63-16612P</b>	F03FR02140
50,8	6	60,3	12	22	3	24.000	<b>63-16112P</b>	F03FR02126
50,8	6,4	60,3	12	22	3	24.000	<b>63-16212P</b>	F03FR02129

	Spare parts	Dimensions mm	Freud Code	Art. No.
	Washer	17 x 8,4 x 1,6	<b>2617M AG9</b>	F03F010005
	Hex nut	7,94 x 6,75	<b>2610M BB9</b>	F03F010003
	Ball bearing	22 x 8 x 7,1	<b>3102M AC9</b>	F03F010008

# Slotting cutters

56- 58-



Z=3

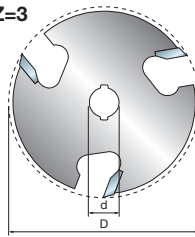

Z=4

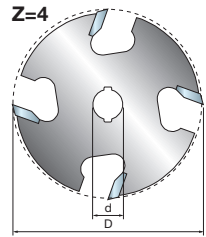

D	h	d	Z	Max RPM	Freud Code	Art. No.
mm	mm	mm		1/min.		
50,8	1,5	8	3	24.000	<b>56-09908P</b>	F03FR02014
50,8	1,6	8	3	16.000	<b>56-10008P</b>	F03FR02015
50,8	2	8	3	24.000	<b>56-10408P</b>	F03FR02016
50,8	2,4	8	3	16.000	<b>56-10608P</b>	F03FR02017
50,8	2,5	8	3	24.000	<b>56-11308P</b>	F03FR02028
50,8	3	8	3	24.000	<b>56-11408P</b>	F03FR02029
50,8	3,2	8	3	24.000	<b>56-10808P</b>	F03FR02019
50,8	3,5	8	3	24.000	<b>56-11508P</b>	F03FR02030
50,8	4	8	3	24.000	<b>56-10908P</b>	F03FR02021
50,8	4,8	8	3	24.000	<b>56-11008P</b>	F03FR02023
50,8	5	8	3	24.000	<b>56-11608P</b>	F03FR02031
50,8	6	8	3	24.000	<b>56-11108P</b>	F03FR02025
50,8	6,4	8	3	24.000	<b>56-11208P</b>	F03FR02026

D	h	d	Z	Max RPM	Freud Code	Art. No.
mm	mm	mm		1/min.		
50,8	1,5	8	4	16.000	<b>58-09908P</b>	F03FR02032
50,8	2	8	4	16.000	<b>58-10408P</b>	F03FR02033
50,8	2,5	8	4	16.000	<b>58-11308P</b>	F03FR02036
50,8	3	8	4	16.000	<b>58-11408P</b>	F03FR02037
50,8	5	8	4	24.000	<b>58-11608P</b>	F03FR02038
50,8	6	8	4	16.000	<b>58-11108P</b>	F03FR02034

JOINERY BITS

# Slotting cutter arbors 60-



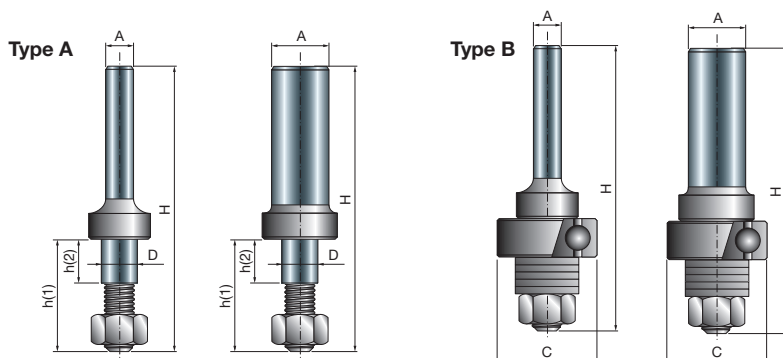

D	h1	h2	H	C	A	Max RPM	Freud Code	Art. No.
mm	mm	mm	mm	mm	mm	1/min.		
7,94	24,6	10	60,3	-	6	24.000	<b>60-10006P</b>	F03FR02039
7,94	24,6	10	60,3	22	6	24.000	<b>60-12006P</b>	F03FR02044
7,94	24,6	10	60,3	-	8	24.000	<b>60-10008P</b>	F03FR02040
7,94	24,6	10	60,3	22	8	24.000	<b>60-12008P</b>	F03FR02045
7,94	24,6	10	60,3	-	12	24.000	<b>60-10212P</b>	F03FR02042
7,94	24,6	10	60,3	22	12	24.000	<b>60-12212P</b>	F03FR02046
7,94	24,6	10	60,3	-	1/4	24.000	<b>60-10025P</b>	F03FR02041
7,94	24,6	10	60,3	-	1/2	24.000	<b>60-10250P</b>	F03FR02043





## Type A

60-10006P - 60-10008P - 60-10212P - 60-10025P - 60-10250P

	Quantity	Spare parts	Dimensions mm	Freud Code	Art. No.
	7	Washer	17 x 8,4 x 1,6	<b>2617M AG9</b>	F03F010005
	1	Hex nut	7,94 x 6,75	<b>2610M BB9</b>	F03F010003

## Type B





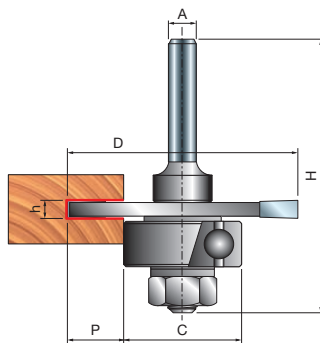

60-12006P - 60-12008P - 60-12212P

	Quantity	Spare parts	Dimensions mm	Freud Code	Art. No.
	5	Washer	17 x 8,4 x 1,6	<b>2617M AG9</b>	F03F010005
	1	Hex nut	7,94 x 6,75	<b>2610M BB9</b>	F03F010003
	1	Ball bearing	22 x 8 x 7	<b>3102M AC9</b>	F03F010008

# Biscuit joint slot cutter 63-



D	h	H	C	P	A	Z	Max RPM	Freud Code	Art. No.	
mm	mm	mm	mm	mm	mm	inch	1/min.			
50,8	3,97	60,3	26-30-34	12,4-10,4-8,4	6	3	24.000	<b>63-60906P</b>	F03FR02143	
50,8	3,97	60,3	26-30-34	12,4-10,4-8,4	8	3	24.000	<b>63-60908P</b>	F03FR02146	
50,8	3,97	60,3	26-30-34	12,4-10,4-8,4	12	3	24.000	<b>63-60912P</b>	F03FR02149	
50,8	3,97	60,3	26-30-34	12,4-10,4-8,4		1/4	3	24.000	<b>63-60925P</b>	F03FR02152
50,8	3,97	60,3	26-30-34	12,4-10,4-8,4		1/2	3	24.000	<b>63-60950P</b>	F03FR02155

Spare parts	Dimensions mm	Freud Code	Art. No.	
	Hex nut	7,94 x 6,75	<b>2610M BB9</b>	F03F010003
	Washer	17 x 8,4 x 1,6	<b>2617M AG9</b>	F03F010005
	Washer	14 x 8,4 x 1,6	<b>2617M BG9</b>	F03FR01668
	Ball bearing	26 x 10 x 8	<b>RB62M 1249</b>	F03F011417
	Ball bearing	30 x 10 x 8	<b>RB62M 1289</b>	F03F011418
	Ball bearing	34 x 10 x 8	<b>RB62ME DA9</b>	F03FR01146

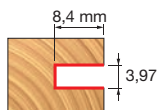
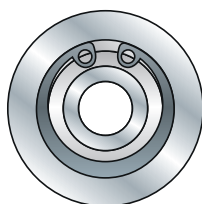

With Bearing **RB62M 1249**  
(34mm)



Biscuit Size-00  
47mm x 15mm

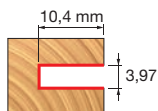
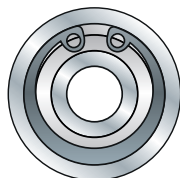
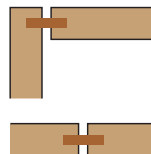

With Bearing **RB62M 1289**  
(30mm)



Biscuit Size-10  
54mm x 19mm

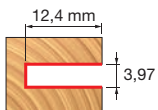
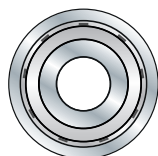

With Bearing **RB62ME DA9**  
(26mm)



Biscuit Size-20  
59mm x 22mm

## Adjustable tongue and groove cutter set 99-

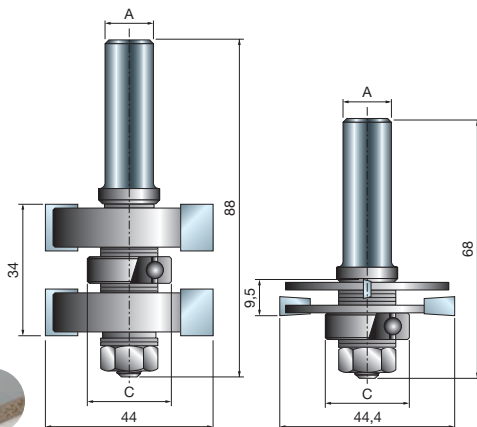

D	h	H	A	C	Z	Max RPM	Freud Code	Art. No.
mm	mm	mm	mm	mm		1/min.		
44	34	88	12	22	2	16.000	99-03612P	F03FR02432
44,4	9,5	68	12	22	2			

	Qty	Spare parts	Dimensions mm	Freud Code	Art. No.
	2	Hex nut	7,94 x 6,75	2610M BB9	F03F010003
	2	Washer	14 x 8,4 x 1,6	2617M BG9	F03FR01668
	2	Ball bearing	22 x 8 x 7,1	3102M AC9	F03F010008
	4	Spacer	18 x 0,1 x 8	AN01MP0019	F03FC00392
	4	Spacer	18 x 0,2 x 8	AN01MP0029	F03FC00393
	2	Spacer	18 x 0,5 x 8	AN01MP0059	F03FC00395
	8	Spacer	18 x 1 x 8	AN01MP0109	F03FC00396
	4	Spacer	18 x 0,15 x 8	AN01MPAA99	F03FC00391

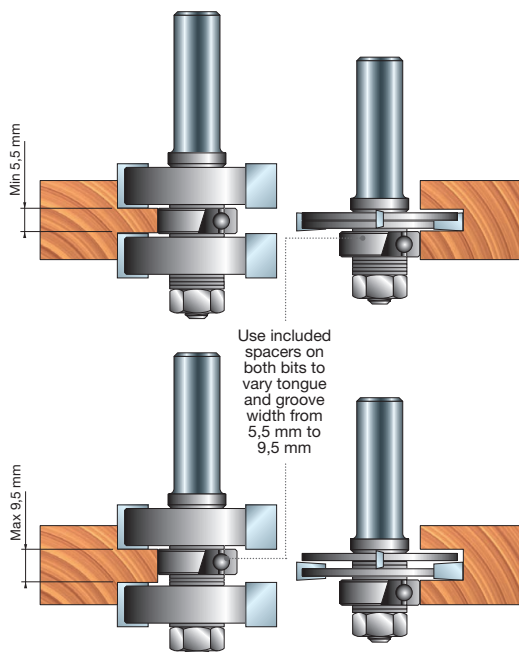



## Rabbeting bits 32-

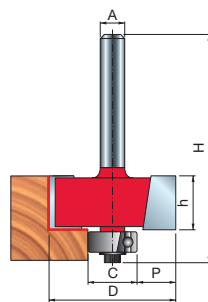

D	h	H	A	C	R	Z	Max RPM	Freud Code	Art. No.	
mm	mm	mm	mm	inch	mm	mm	1/min.			
31,75	13,2	55,7	6		12,7	9,52	2	18.000	<b>32-10006P</b>	F03FR01745
34,92	12,7	54,4	6		12,7	11,1	2	16.000	<b>32-50006P</b>	F03FR01750
31,75	13,2	55,7	8		12,7	9,52	2	18.000	<b>32-10008P</b>	F03FR01746
34,92	12,7	54,7	8		12,7	11,1	2	16.000	<b>32-50008P</b>	F03FR01751
31,75	13,2	61,7	12		12,7	9,52	2	18.000	<b>32-10212P</b>	F03FR01748
34,92	12,7	60,7	12		12,7	11,1	2	16.000	<b>32-52012P</b>	F03FR01758
31,75	13,2	55,7		1/4	12,7	9,52	2	18.000	<b>32-10025P</b>	F03FR01747
31,75	13,2	61,7		1/2	12,7	9,52	2	18.000	<b>32-10250P</b>	F03FR01749







## Rabbeting bits with bearing set











### Rabbeting bits with a set of 4 ball bearings

D	h	H	A	C	P	Z	Max RPM	Freud Code	Art. No.	
mm	mm	mm	mm	inch	mm	mm	1/min.			
34,92	12,7	54,4	6		9,53-19,05	7,94-12,7	2	16.000	<b>32-50206P</b>	F03FR01752
34,92	12,7	54,4	8		9,53-19,05	7,94-12,7	2	16.000	<b>32-50208P</b>	F03FR01753
34,92	12,7	60,7	12		9,53-19,05	7,94-12,7	2	16.000	<b>32-52212P</b>	F03FR01759
34,92	12,7	60,7		1/2	9,53-15,88	9,53-12,7	2	16.000	<b>32-52250P</b>	F03FR01760

### Rabbeting bits with a set of 7 ball bearings

D	h	H	A	C	P	Z	Max RPM	Freud Code	Art. No.
mm	mm	mm	mm	mm	mm		1/min.		
34,92	12,7	54,7	6	9,53-34,92	0-12,7	2	16.000	<b>32-50406P</b>	F03FR01755
34,92	12,7	54,4	8	9,53-34,92	0-12,7	2	16.000	<b>32-50408P</b>	F03FR01756
34,92	12,7	60,7	12	9,53-34,92	0-12,7	2	16.000	<b>32-52412P</b>	F03FR01761

	Spare parts	Dimensions mm	Freud Code	Art. No.	
	Screw	M3 x 7,6	<b>2607M 001</b>	F03F010000	
	Allen key	2,5	<b>2619M CA9</b>	F03FA07432	
	Washer	9 x 2 x 6	<b>FX07M AA9</b>	F03F010158	
	Washer	12 x 1,1 x 4,8	<b>FX07M AB9</b>	F03F010159	
<b>32-52250P</b>		Ball bearing	9,53 x 3,2 x 4,76	<b>3102M AA9</b>	F03F010006
		Ball bearing	12,7 x 4,98 x 4,76	<b>3102M AB9</b>	F03F010007
		Ball bearing	15,88 x 4,97 x 4,76	<b>3102M AJ9</b>	F03F010014

		Spare parts	Dimensions mm	Freud Code	Art. No.
32-50206P 32-50208P 32-52212P		Ball bearing	9,53 x 3,2 x 4,76	<b>3102M AA9</b>	F03F010006
		Ball bearing	12,7 x 4,98 x 4,76	<b>3102M AB9</b>	F03F010007
		Ball bearing	15,88 x 4,97 x 4,76	<b>3102M AJ9</b>	F03F010014
32-50406P 32-50408P 32-52412P		Ball bearing	19,05 x 8 x 4,76	<b>RB62M 1509</b>	F03F011422
		Ball bearing	9,53 x 3,2 x 4,76	<b>3102M AA9</b>	F03F010006
		Ball bearing	12,7 x 4,98 x 4,76	<b>3102M AB9</b>	F03F010007
		Ball bearing	15,88 x 4,97 x 4,76	<b>3102M AJ9</b>	F03F010014
		Ball bearing	19,05 x 8 x 4,76	<b>RB62M 1509</b>	F03F011422
		Ball bearing	22,22 x 8 x 4,76	<b>RB62M 1529</b>	F03F011423
		Ball bearing	28,58 x 8 x 4,76	<b>RB62M 1549</b>	F03F011424
	Ball bearing	34,92 x 8 x 4,76	<b>RB62M 1569</b>	F03F011425	

## Keyhole bit 70-

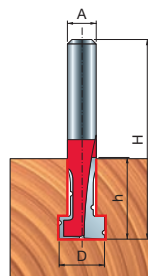
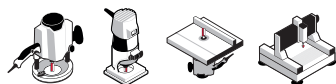

D	h	H	A	Z	Max RPM	Freud Code	Art. No.
mm	mm	mm	mm		1/min.		
10	17	48,2	6	2	24.000	<b>70-10406P</b>	F03FR02159

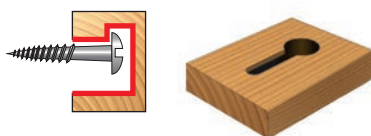

Example of keyhole

## T-slotting bits 52-

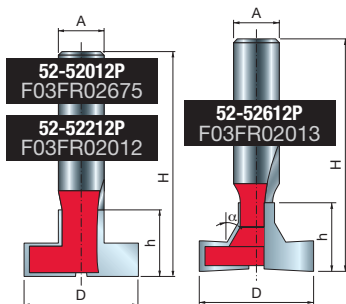
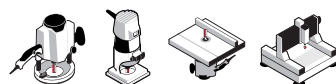

D	h	H	A	$\alpha$	Z	Max RPM	Freud Code	Art. No.
mm	mm	mm	mm			1/min.		
28	16	59	12	-	2	22.000	<b>52-52012P</b>	F03FR02675
28,58	20,6	63,5	12	-	2	18.000	<b>52-52212P</b>	F03FR02012
30	18	61	12	30°	2	18.000	<b>52-52612P</b>	F03FR02013

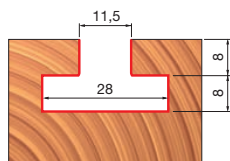

**52-52012P**  
F03FR02675

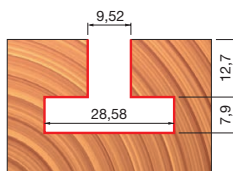

**52-52212P**  
F03FR02012

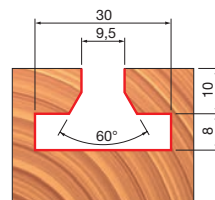

**52-52612P**  
F03FR02013

## Dovetail Bits 22-

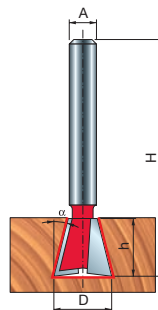
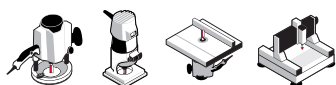

D	h	H	A	$\alpha$	Z	Max RPM	Freud Code	Art. No.
mm	mm	mm	mm	inch		1/min.		
9,52	10,5	47,5	6		2	24.000	<b>22-10206P</b>	F03FR01640
12,7	12,7	50,7	6	9°	2	24.000	<b>22-10406P</b>	F03FR01643
15,88	22,2	54,2	6	14°	2	24.000	<b>22-10506P</b>	F03FR01646
19,05	22,2	54,2	6	7°	2	24.000	<b>22-10606P</b>	F03FR01648
9,52	10,5	47,5	8		2	24.000	<b>22-10208P</b>	F03FR01641
12,7	12,7	50,7	8	9°	2	24.000	<b>22-10408P</b>	F03FR01644
15,88	22,2	54,2	8	14°	2	24.000	<b>22-10508P</b>	F03FR01647
19,05	22,2	54,2	8	7°	2	24.000	<b>22-10608P</b>	F03FR01649
12,7	12,7	59,7	12		2	24.000	<b>22-11212P</b>	F03FR01650
19,05	22,2	66,7	12	9°	2	24.000	<b>22-11412P</b>	F03FR01653
9,52	9,9	44,9		1/4	2	24.000	<b>22-10225P</b>	F03FR01642
12,7	12,7	50,7		1/4	2	24.000	<b>22-10425P</b>	F03FR01645
12,7	12,7	59,7		1/2	2	24.000	<b>22-11250P</b>	F03FR01651

# Lock mitre bits 45° 99-

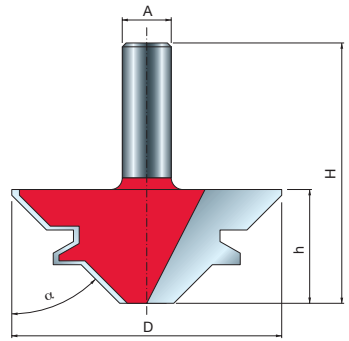
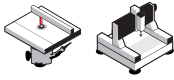

D	h	H	A	$\alpha$	Z	Max RPM	Freud Code	Art. No.
mm	mm	mm	mm			1/min.		
55	23	61	12	45°	2	16.000	<b>99-03512P</b>	F03FR02425
70	29,5	67,5	12	45°	2	12.000	<b>99-03412P</b>	F03FR02424

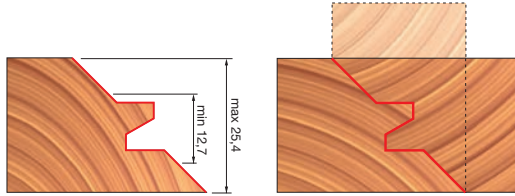

## Simple Joint

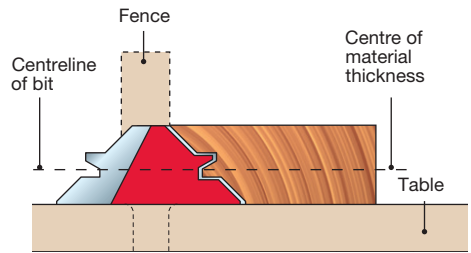
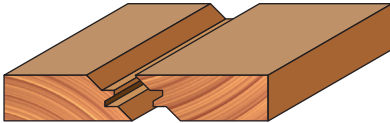

## 45° Mitre Join

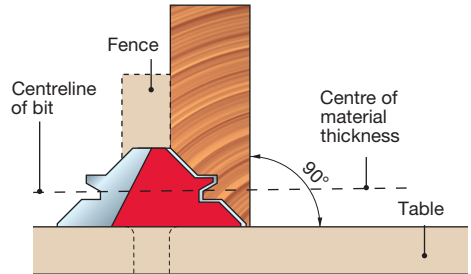
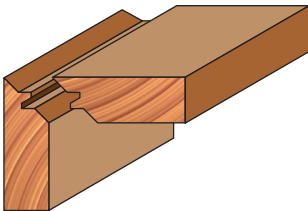

# 2 Piece lock mitre bit set 22,5° 99-

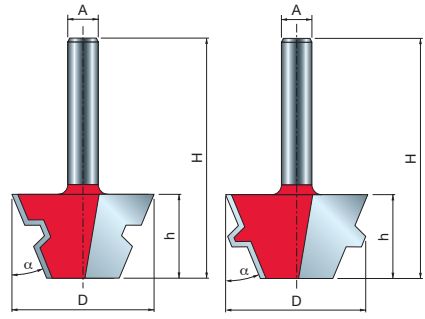
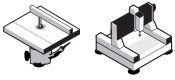

D	h	H	A	$\alpha$	Z	Max RPM	Freud Code	Art. No.
mm	mm	mm	mm			1/min.		
37,3	22,2	54,2	8	22,5°	2	24.000	<b>99-04308P</b>	F03FR02450

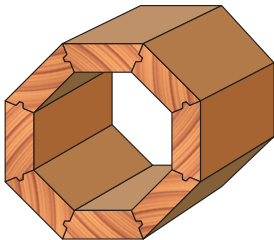
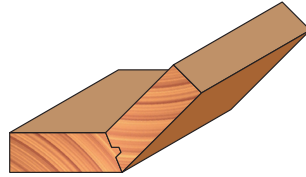
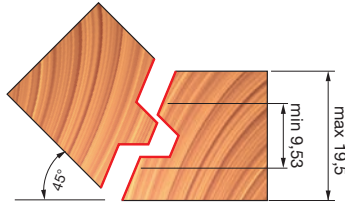
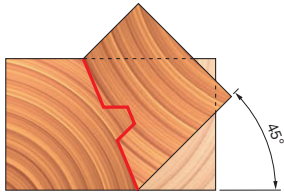

## Reversible glue joint bits 99-

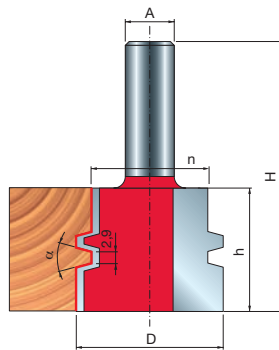
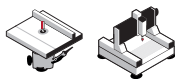

D	h	H	n	A	$\alpha$	Z	Max RPM	Freud Code	Art. No.
mm	mm	mm	mm	mm	inch		1/min.		
38	32	70	30,2	12	15°	2	16.000	<b>99-03112P</b>	F03FR02422
38	32	70	30,2	1/2	15°	2	16.000	<b>99-03150P</b>	F03FR02423

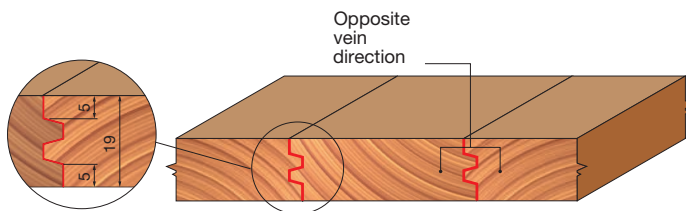

## Finger joint bit 99-

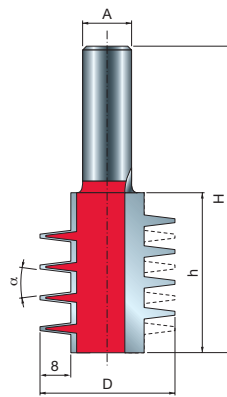
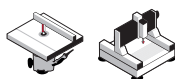

D	h	H	A	$\alpha$	Z	Max RPM	Freud Code	Art. No.
mm	mm	mm	mm			1/min.		
35	41,5	79,5	12	14°	2	16.000	<b>99-03712P</b>	F03FR02440

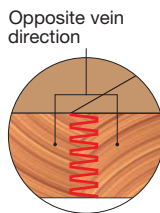
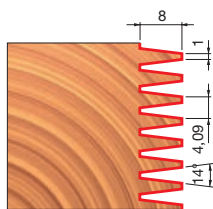



## Top bearing finger joint bit - Type A 99-

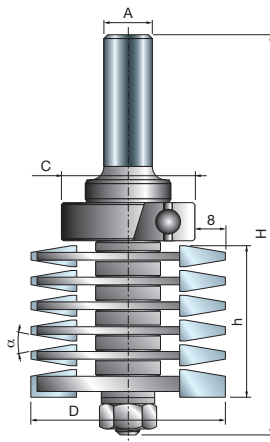

D	h	H	A	C	$\alpha$	Z	Max RPM	Freud Code	Art. No.
mm	mm	mm	mm	mm			1/min.		
50,8	45,2	108	12	35	20°	2	24.000	<b>99-03912P</b>	F03FR02444

	Spare parts	Dimensions mm	Freud Code	Art. No.
	Hex nut	7,94 x 6,75	<b>2610M BB9</b>	F03F010003
	Washer	14 x 8,4 x 1,6	<b>2617M BG9</b>	F03FR01668
	Ball bearing	35 x 15 x 11	<b>3102M AI9</b>	F03F012285
	Spacer	18 x 0,1 x 8	<b>AN01MP0019</b>	F03FC00392
	Spacer	18 x 1 x 8	<b>AN01MP0109</b>	F03FC00396
	Spacer	18 x 2,5 x 8	<b>AN01MP0259</b>	F03FC00398
	Spacer	18 x 4,4 x 8	<b>AN01MP0449</b>	F03FC00399

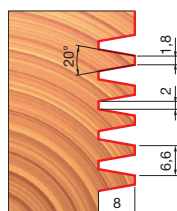



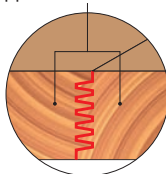

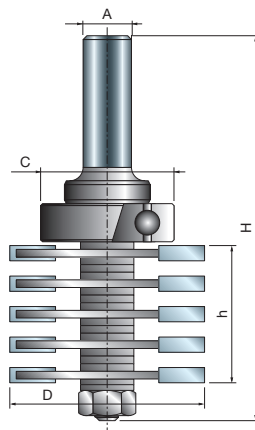

Opposite vein direction



## Top bearing finger joint bit - Type B 99-



D	h	H	A	C	Z	Max RPM	Freud Code	Art. No.
mm	mm	mm	mm	mm		1/min.		
47	36	101	12	28	2	24.000	<b>99-0421P</b>	F03FR02447

	Spare parts	Dimensions mm	Freud Code	Art. No.
	Hex nut	7,94 x 6,75	<b>2610M BB9</b>	F03F010003
	Washer	14 x 8,4 x 1,6	<b>2617M BG9</b>	F03FR01668
	Ball bearing	28 x 12 x 8	<b>3102M AH9</b>	F03F010013
	Spacer	18 x 0,2 x 8	<b>AN01MP0029</b>	F03FC00393
	Spacer	18 x 1 x 8	<b>AN01MP0109</b>	F03FC00396
	Spacer	18 x 0,5 x 8	<b>AN01MP0059</b>	F03FC00395
	Spacer	18 x 4,4 x 8	<b>AN01MP0449</b>	F03FC00399

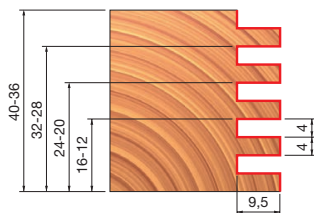

Opposite vein direction

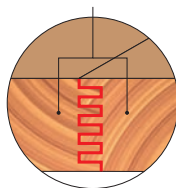

# Drawer lock bit 99-

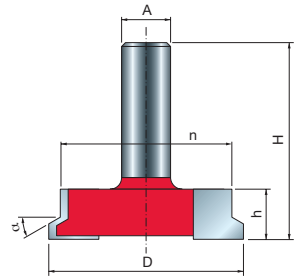

D	h	H	A	n	$\alpha$	Z	Max RPM	Freud Code	Art. No.
mm	mm	mm	mm	mm			1/min.		
50,5	13	49	12	44,5	30°	2	16.000	99-24012P	F03FR02463

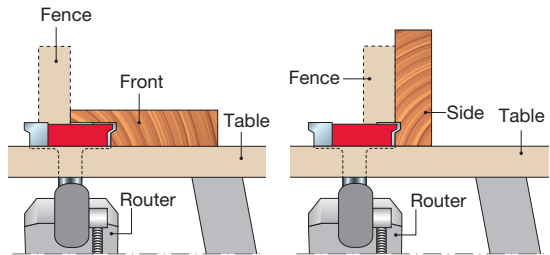
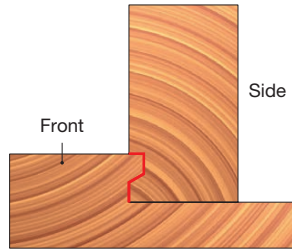
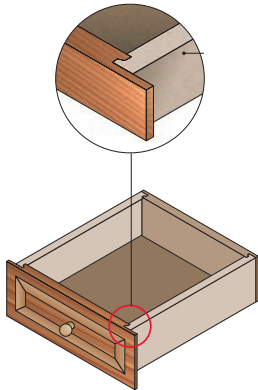

# Door pull bit 99-

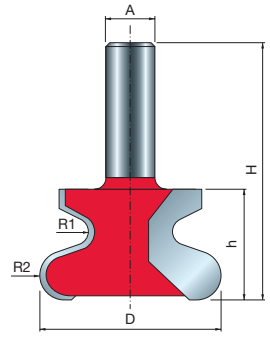

D	h	H	A	R1	R2	Z	Max RPM	Freud Code	Art. No.
mm	mm	mm	mm	mm	mm		1/min.		
47	28,7	66,7	12	3,2	6,35	2	16.000	<b>99-00712P</b>	F03FR02413

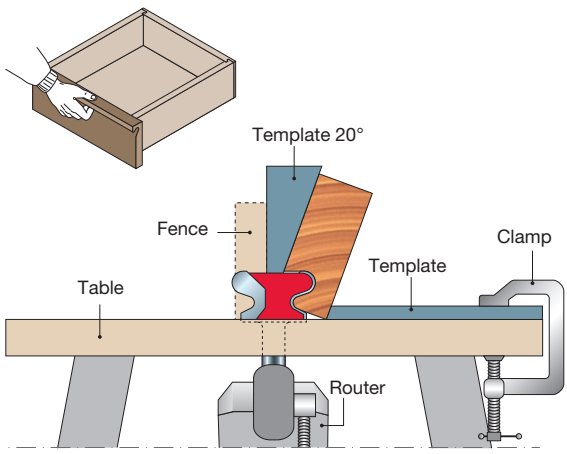
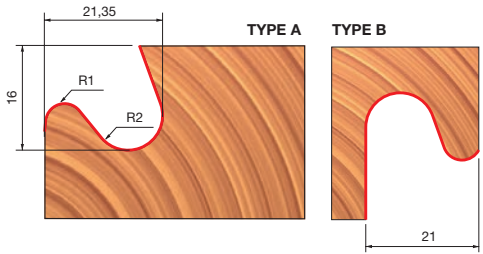

JOINERY  
BITS

## Matched profile and scribe bits

99-



D	H	A	R1	R2	C	Z	Max RPM	Freud Code	Art. No.
mm	mm	mm	inch	mm	mm	mm	1/min.		
42,9	77	12	5,5	-	22	2	24.000	<b>99-26012P</b>	F03FR02468
42,9	77	12	4,5	5,5	22	2	24.000	<b>99-26112P</b>	F03FR02478
42,9	77	12	7	-	22	2	24.000	<b>99-26312P</b>	F03FR02488
42,9	77	1/2	4,5	5,5	22	2	24.000	<b>99-26150P</b>	F03FR02483
42,9	77	1/2	7	-	22	2	24.000	<b>99-26350P</b>	F03FR02493

	Spare parts	Dimensions mm	Freud Code	Art. No.
	Hex nut	7,94 x 6,75	<b>2610M BB9</b>	F03F010003
	Spacer	18 x 0,1 x 8	<b>AN01MP0019</b>	F03FC00392
	Spacer	18 x 0,2 x 8	<b>AN01MP0029</b>	F03FC00393
	Spacer	18 x 0,5 x 8	<b>AN01MP0059</b>	F03FC00395
	Spacer	18 x 1 x 8	<b>AN01MP0109</b>	F03FC00396
	Ball bearing	22 x 8 x 7,1	<b>3102M AC9</b>	F03F010008

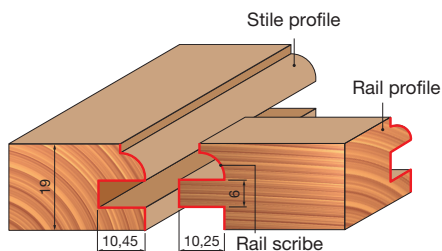
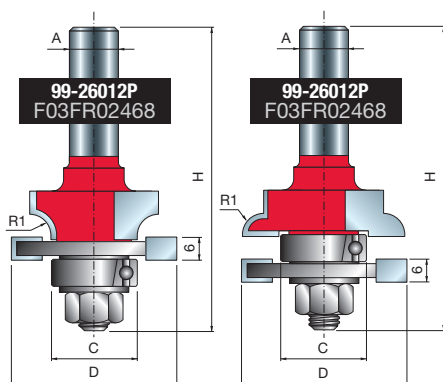

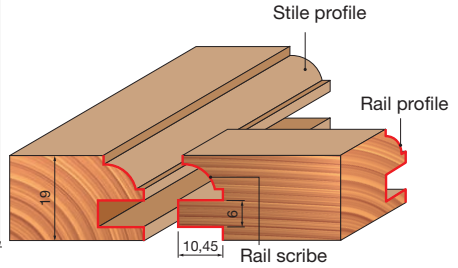
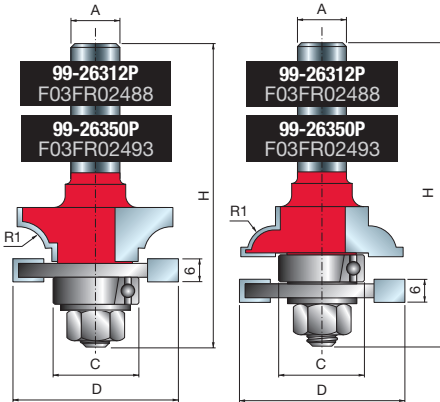
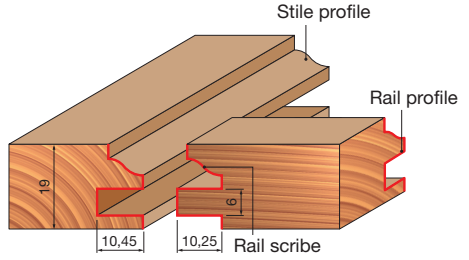
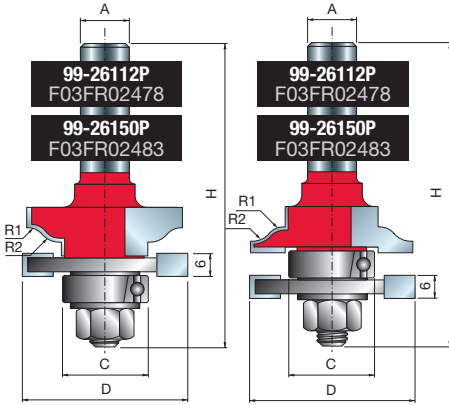

## Matched profile and scribe bits

### 99-



D	h	H	A	R1	R2	C	Z	Max RPM	Freud Code	Art. No.
mm	mm	mm	mm	inch	mm	mm	mm	1/min.		
50,4	32,7	104	12	5,5	-	32	2	14.000	<b>99-29012P</b>	F03FR02494
50,4	32,7	104	12	5,5	4,5	32	2	14.000	<b>99-29112P</b>	F03FR02496
50,4	32,7	104	12	7	-	32	2	14.000	<b>99-29312P</b>	F03FR02498
50,4	32,7	104	1/2	5,5	-	32	2	14.000	<b>99-29050P</b>	F03FR02495
50,4	32,7	104	1/2	7	-	32	2	14.000	<b>99-29350P</b>	F03FR02499

	Spare parts	Dimensions mm	Freud Code	Art. No.
	Hex nut	7,94 x 6,75	<b>2610M BB9</b>	F03F010003
	Retaining ring	15 x 13,9	<b>2621ME 015</b>	F03FA07444
	Ball bearing	32 x 15 x 9	<b>3102M AN9</b>	F03F010016
	Spacer	18 x 1 x 8	<b>AN01MP0109</b>	F03FC00396

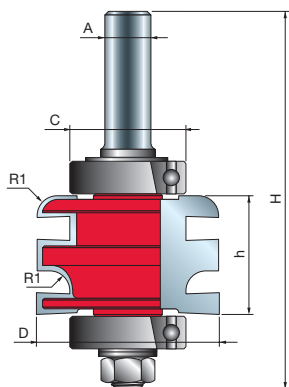

**99-29012P**  
F03FR02494

**99-29050P**  
F03FR02495

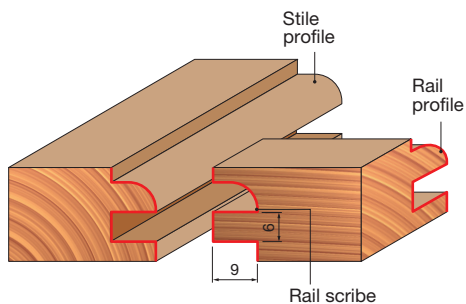



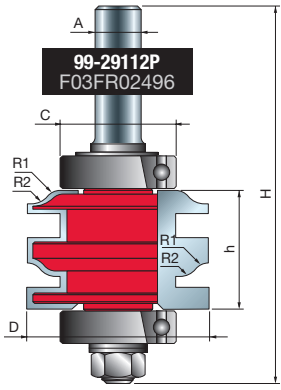

**99-29112P**  
F03FR02496

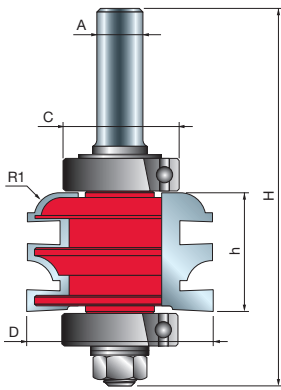
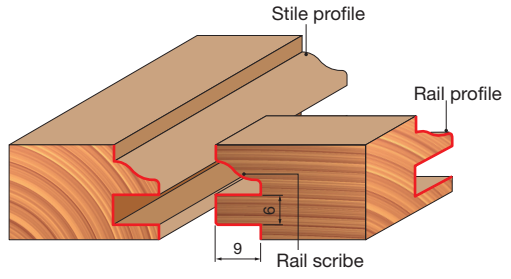

**99-29312P**  
F03FR02498

**99-29350P**  
F03FR02499

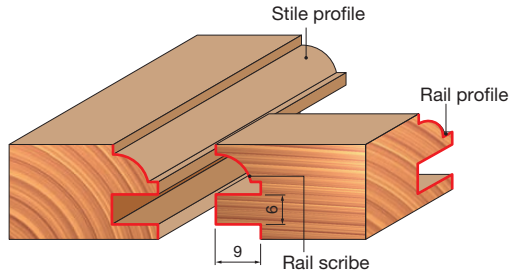





# Window router bits

99-



D	h	H	A	m	C	R	Z	Max RPM	Freud Code	Art. No.
mm	mm	mm	mm	mm	mm	mm		1/min.		
34	35,9	78,4	12	14,5	22	6	2	16.000	<b>99-05112P</b>	F03FR02455
38	15,5	53,5	12	-	-	6	2	16.000	<b>99-05012P</b>	F03FR02451

	Spare parts	Dimensions mm	Freud Code	Art. No.
	Hex nut	7,94 x 6,75	<b>2610M BB9</b>	F03F010003
	Washer	14 x 8,4 x 1,6	<b>2617M BG9</b>	F03FR01668
	Ball bearing	22 x 8 x 7,1	<b>3102M AC9</b>	F03F010008
	Spacer	18 x 0,1 x 8	<b>AN01MP0019</b>	F03FC00392

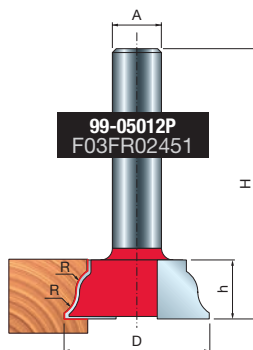
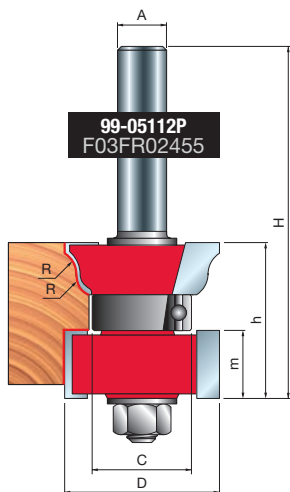

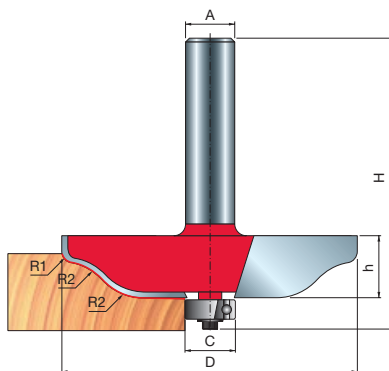

## Raised panel bits 99-



Type A

D	h	H	A	C	R1	R2	Z	Max RPM	Freud Code	Art. No.	
mm	mm	mm	mm	inch	mm	mm	mm	1/min.			
76,2	16	64,7	12		12,7	2	16	2	12.000	<b>99-22112P</b>	F03FR02458
70	16	64,5		1/2	12,7	14	3	4	12.000	<b>99-51050P</b>	F03FR02504
89	16	64,5		1/2	12,7	20	4	4	10.000	<b>99-52050P</b>	F03FR02512

	Spare parts	Dimensions mm	Freud Code	Art. No.
	Screw	M3 x 7,6	<b>2607M 001</b>	F03F010000
	Ball bearing	12,7 x 4,98 x 4,76	<b>3102M AB9</b>	F03F010007
	Washer	12 x 1,1 x 4,8	<b>FX07M AB9</b>	F03F010159

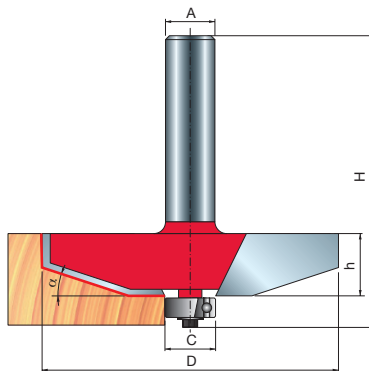

Type B

D	h	H	A	C	α	Z	Max RPM	Freud Code	Art. No.	
mm	mm	mm	mm	inch	mm	mm	1/min.			
76,2	16	64,7	12		12,7	2	2	12.000	<b>99-22112P</b>	F03FR02458
70	16	64,5		1/2	12,7	14	4	12.000	<b>99-51050P</b>	F03FR02504
89	16	64,5		1/2	12,7	20	4	10.000	<b>99-52050P</b>	F03FR02512

For spare parts check **Type A** table.

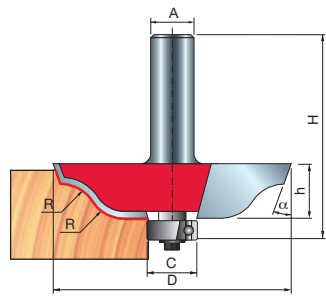

Type C

D	h	H	A	C	$\alpha$	R	Z	Max RPM	Freud Code	Art. No.
mm	mm	mm	inch	mm		mm		1/min.		
70	16	64,5	1/2	12,7	20°	11	4	12.000	99-51350P	F03FR02507

For spare parts check **Type A** table.

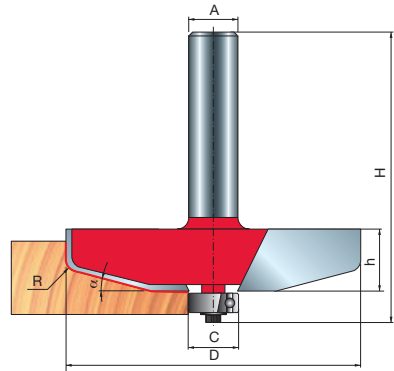

Type D

D	h	H	A	C	$\alpha$	R	Z	Max RPM	Freud Code	Art. No.
mm	mm	mm	inch	mm		mm		1/min.		
76,2	16	60	12	12,7	15°	4,8	2	12.000	99-22412P	F03FR02461

For spare parts check **Type A** table.

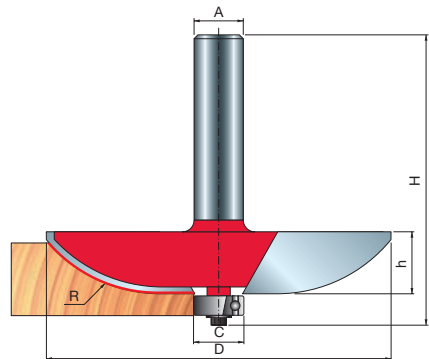

Type E

D	h	H	A	C	R	Z	Max RPM	Freud Code	Art. No.	
mm	mm	mm	mm	inch	mm	mm	1/min.			
89	16	64,7	12		12,7	38,1	2	10.000	99-22512P	F03FR02462
89	16	64,5	1/2	12,7	38	4	10.000	99-51850P	F03FR02510	

For spare parts check **Type A** table.

# Raised panel bits with back cutters

99-



D	h	H	A	$\alpha$	R1	R2	Z	Max RPM	Freud Code	Art. No.
mm	mm	mm	mm		mm	mm		1/min.		
89	25	75	12	15°	6	-	2	14.000	<b>99-56612P</b>	F03FR02515
89	25	75	12	15°	38	6	2	14.000	<b>99-56912P</b>	F03FR02523
89	25	75	12	15°	30	6	2	14.000	<b>99-57112P</b>	F03FR02529

	Spare parts	Dimensions mm	Freud Code	Art. No.
	Hex nut	7,94 x 6,75	<b>2610M BB9</b>	F03F010003
	Spacer	18 x 0,1 x 8	<b>AN01MP0019</b>	F03FC00392
	Spacer	18 x 0,2 x 8	<b>AN01MP0029</b>	F03FC00393
	Spacer	18 x 0,5 x 8	<b>AN01MP0059</b>	F03FC00395
	Spacer	18 x 1 x 8	<b>AN01MP0109</b>	F03FC00396
	Spacer	18 x 0,15 x 8	<b>AN01MPAA99</b>	F03FC00391

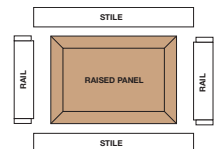
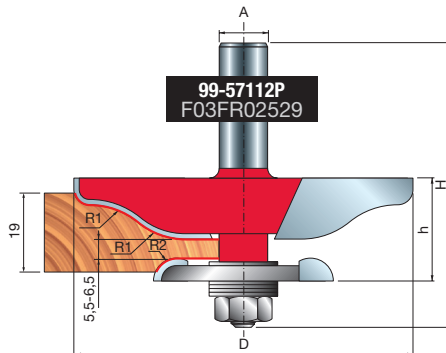
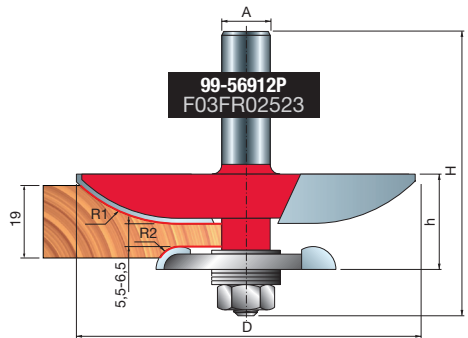
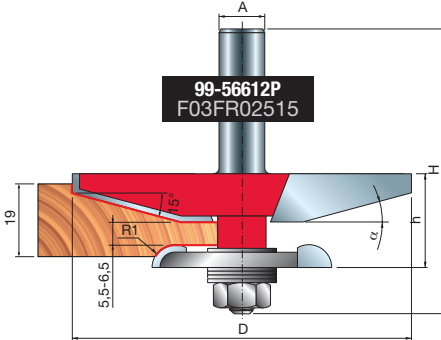

# Vertical raised panel bits

99-

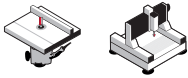

D	h	H	A	$\alpha$	R1	R2	Z	Max RPM	Freud Code	Art. No.
mm	mm	mm	mm		mm	mm		1/min.		
31,8	41,5	79,5	12	-	2	16	2	16.000	<b>99-32212P</b>	F03FR02500
31,8	41,5	79,5	12	18°	-	-	2	16.000	<b>99-32312P</b>	F03FR02501
31,8	41,5	79,5	12	15°	4,8	-	2	16.000	<b>99-32412P</b>	F03FR02502
31,8	41,5	79,5	12	-	38,1	-	2	16.000	<b>99-32512P</b>	F03FR02503

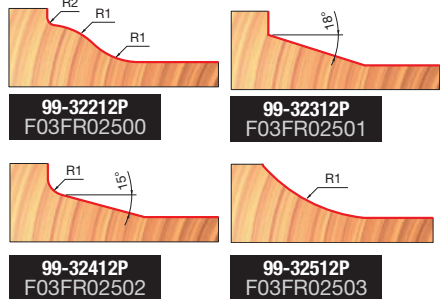
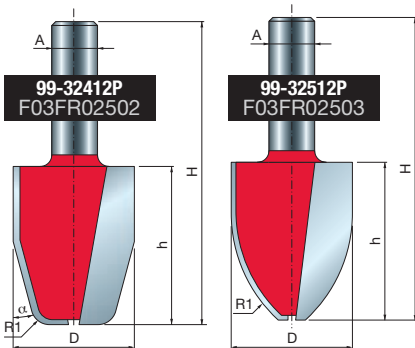
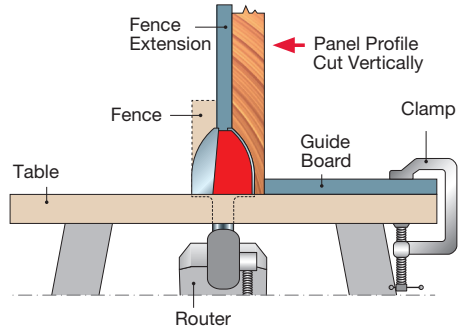
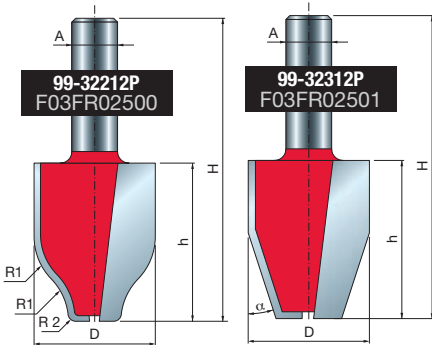

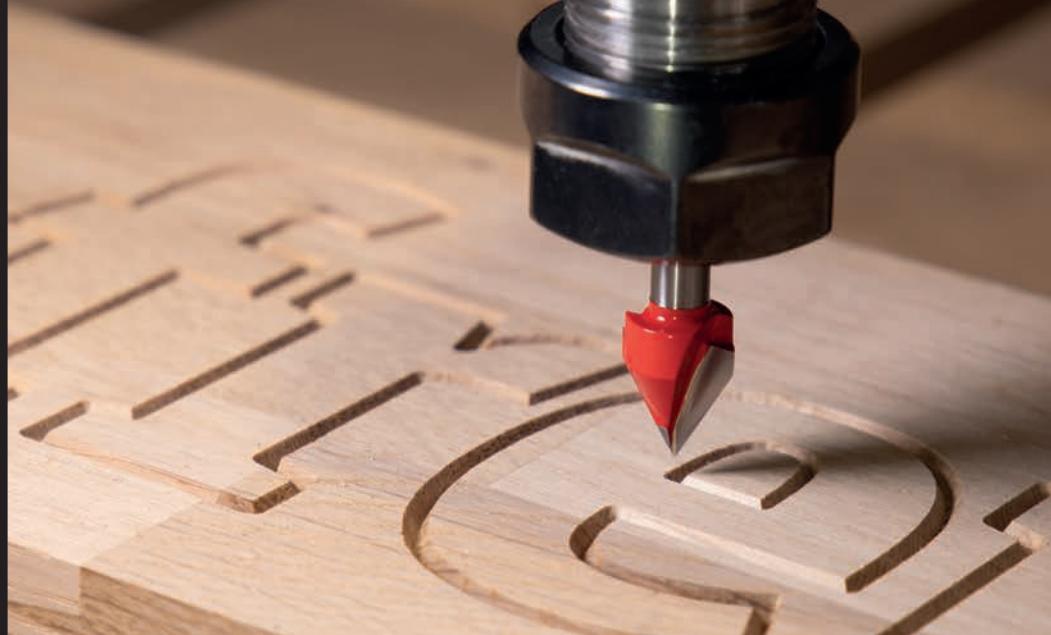

## SURFACE FORMING BITS

### V-groove bits 20- PI01

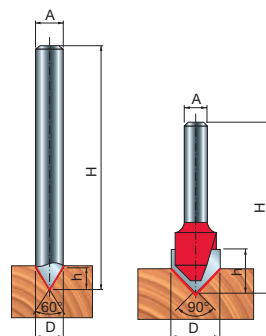
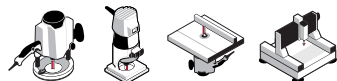

D	h	H	A	$\alpha$	Z	Max RPM	Freud Code	Art. No.
mm	mm	mm	mm	inch		1/min.		
• 6	6	38,1	6	90°	1	24.000	<b>20-10006P</b>	F03FR01617
9,5	10	44,4	6	90°	2	24.000	<b>20-10206P</b>	F03FR01619
12,7	10	44,4	6	90°	2	24.000	<b>20-10406P</b>	F03FR01622
12,7	12,7	49,2	6	60°	2	24.000	<b>20-15206P</b>	F03FR01629
12,7	11	57,3	6	60°	3	24.000	<b>20-15406P</b>	F03FR01632
• 6	6	38,1	8	90°	1	24.000	<b>20-10008P</b>	F03FR01618
• 8	6	70	8	60°	1	30.000	<b>PI01MD6083</b>	F03FR00382
• 8	8	70	8	60°	1	24.000	<b>20-16008P</b>	F03FR01634
9,5	10	44,4	8	90°	2	24.000	<b>20-10208P</b>	F03FR01620
12,7	10	44,4	8	90°	2	24.000	<b>20-10408P</b>	F03FR01623
12,7	12,7	50,8	8	60°	2	24.000	<b>20-15208P</b>	F03FR01630
12,7	11	54	8	60°	3	24.000	<b>20-15408P</b>	F03FR01633
31,75	16	51	8	90°	2	24.000	<b>20-91408P</b>	F03FR02857

D	h	H	A	$\alpha$	Z	Max RPM	Freud Code	Art. No.
mm	mm	mm	mm	inch		1/min.		
15,88	12,5	56,5	12		2	24.000	<b>20-10612P</b>	F03FR01625
19,05	12,5	57,2	12		2	24.000	<b>20-10812P</b>	F03FR01626
9,53	10	44,4		1/4	2	24.000	<b>20-10225P</b>	F03FR01621
12,7	10	44,4		1/4	2	24.000	<b>20-10425P</b>	F03FR01624
12,7	12,7	47,5		1/4	2	24.000	<b>20-15225P</b>	F03FR01631
12,7	12,7	54,7		1/2	2	24.000	<b>20-10950P</b>	F03FR01628

• Solid Carbide Bits

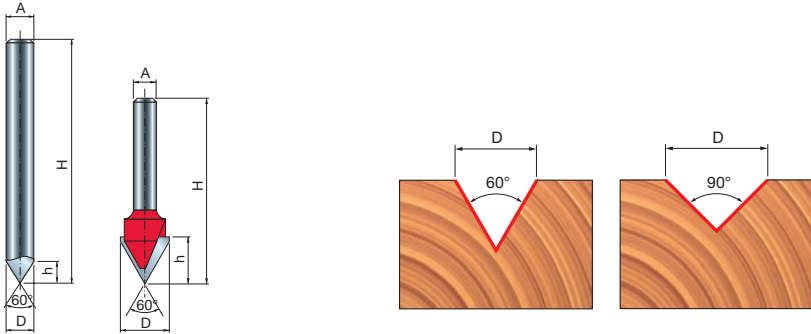

Solid Carbide Bits

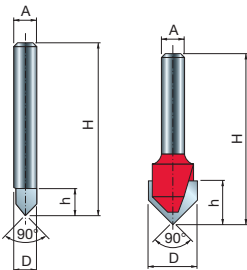

Solid Carbide Bits

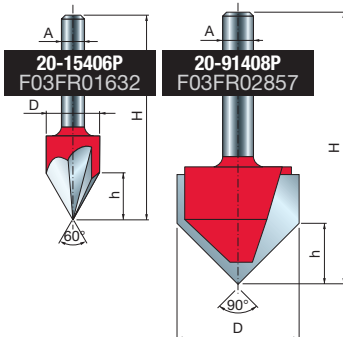



## V-groove bits for ACM panel folding 21-

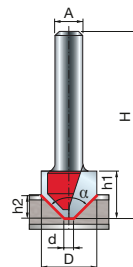
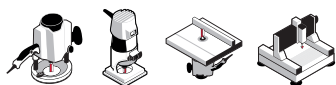

D	h1	h2	H	A	C	$\alpha$	Z	Max RPM	Freud Code	Art. No.
mm	mm	mm	mm	mm	inch	mm		1/min.		
16	12,5	6,8	50,8	6	2,5	90°	2	24.000	<b>21-11206P</b>	F03FR04018
19,05	12,5	6	50,8	6	2,5	108°	2	24.000	<b>21-14606P</b>	F03FR04021
22,23	12,5	4,2	50,8	6	2,29	135°	2	24.000	<b>21-18206P</b>	F03FR04024
16	12,5	6,8	50,8	8	2,5	90°	2	24.000	<b>21-11208P</b>	F03FR04019
19,05	12,5	6	50,8	8	2,5	108°	2	24.000	<b>21-14608P</b>	F03FR04022
22,23	12,5	4,2	50,8	8	2,29	135°	2	24.000	<b>21-18208P</b>	F03FR04025
12,7	10,8	5,2	50,8	1/4	2,29	90°	2	24.000	<b>21-11025P</b>	F03FR04017
16	12,7	6,8	50,8	1/4	2,5	90°	2	24.000	<b>21-11225P</b>	F03FR04020
19,05	12,7	6	50,8	1/4	2,5	108°	2	24.000	<b>21-14625P</b>	F03FR04023
22,23	12,7	4,2	50,8	1/4	2,29	135°	2	24.000	<b>21-18225P</b>	F03FR04026

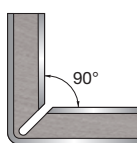

$\alpha = 90^\circ$

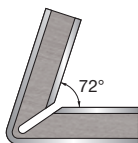

$\alpha = 108^\circ$

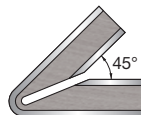

$\alpha = 135^\circ$

## Rectangular groove bits for ACM panel folding 21-

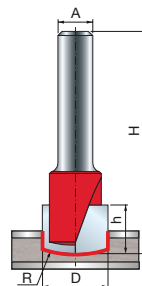
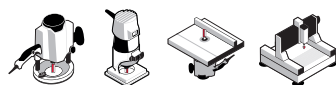

D	h	H	A	R	Z	Max RPM	Freud Code	Art. No.
mm	mm	mm	mm	inch	mm	1/min.		
15,88	11	50	8	23,8	2	24.000	<b>21-20008P</b>	F03FR03967
15,88	11	50,8	1/4	23,8	2	24.000	<b>21-20025P</b>	F03FR03963

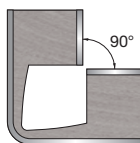

## Lettering bits

20-

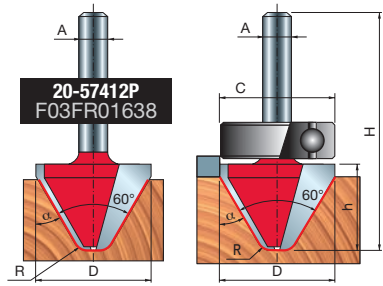
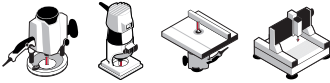

D	h	H	A	C	R	$\alpha$	Z	Max RPM	Freud Code	Art. No.
mm	mm	mm	mm	mm	mm			1/min.		
25,4	19	51,05	6	-	3	60°	2	24.000	<b>20-17206P</b>	F03FR01635
25,4	19	51,05	8	-	3	60°	2	24.000	<b>20-17208P</b>	F03FR01636
28,57	19	57	12	-	3	60°	2	18.000	<b>20-17412P</b>	F03FR01637
28	19	67,15	12	28	3	60°	2	18.000	<b>20-57412P</b>	F03FR01638

## Round nose bits

18-

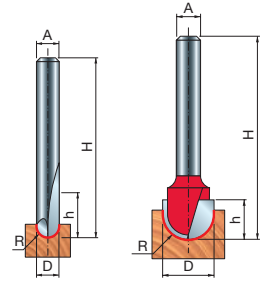
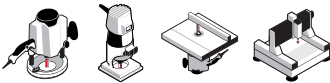

D	h	H	A	R	Z	Max RPM	Freud Code	Art. No.
mm	mm	mm	mm	inch	mm	1/min.		
• 3,2	9,5	50,5	6	1,6	2	24.000	<b>18-10006P</b>	F03FR01581
• 4,8	9,5	50,5	6	2,4	2	24.000	<b>18-10206P</b>	F03FR01584
• 6	12,7	50,8	6	3	2	24.000	<b>18-10406P</b>	F03FR01587
• 9,52	9	46	6	4,8	2	24.000	<b>18-10606P</b>	F03FR01590
• 12	9	46	6	6	2	24.000	<b>18-10806P</b>	F03FR01593
• 15,88	11	50,8	6	8	2	24.000	<b>18-11006P</b>	F03FR01596
• 19,05	11	50,8	6	9,5	2	24.000	<b>18-11206P</b>	F03FR01599
• 3,2	9,5	50,5	8	1,6	2	24.000	<b>18-10008P</b>	F03FR01582
• 4,8	9,5	50,5	8	2,4	2	24.000	<b>18-10208P</b>	F03FR01585
• 6	12,7	50,8	8	3	2	24.000	<b>18-10408P</b>	F03FR01588
• 9,52	9	46	8	4,8	2	24.000	<b>18-10608P</b>	F03FR01591
• 12	9	46	8	6	2	24.000	<b>18-10808P</b>	F03FR01594
• 15,88	11	50,8	8	8	2	24.000	<b>18-11008P</b>	F03FR01597
• 19,05	11	50,8	8	9,5	2	24.000	<b>18-11208P</b>	F03FR01600
• 6	9,5	57	12	3	2	24.000	<b>18-11412P</b>	F03FR01602
• 12,7	31,7	71,5	12	6,35	2	24.000	<b>18-11612P</b>	F03FR01604
• 19,05	31,7	73	12	9,5	2	24.000	<b>18-12212P</b>	F03FR01606
• 25,4	31,7	73	12	12,7	2	24.000	<b>18-12612P</b>	F03FR01608
• 3,18	9,5	50,5	1/4	1,59	2	24.000	<b>18-10025P</b>	F03FR01583

D	h	H	A	R	Z	Max RPM	Freud Code	Art. No.
mm	mm	mm	mm	inch	mm	1/min.		
4,76	6,4	50,5	1/4	2,38	2	24.000	<b>18-10225P</b>	F03FR01586
6,35	12,7	50,5	1/4	3,18	2	24.000	<b>18-10425P</b>	F03FR01589
9,52	9	45	1/4	4,77	2	24.000	<b>18-10625P</b>	F03FR01592
12,7	9	45,5	1/4	6,35	2	24.000	<b>18-10825P</b>	F03FR01595
15,88	11	48	1/4	7,94	2	24.000	<b>18-11025P</b>	F03FR01598
19,05	11	48	1/4	9,53	2	24.000	<b>18-11225P</b>	F03FR01601
6,35	12,7	61	1/2	3,18	2	24.000	<b>18-11450P</b>	F03FR01603
12,7	31,7	72,7	1/2	6,35	2	24.000	<b>18-11650P</b>	F03FR01605
19	31,7	73	1/2	9,5	2	24.000	<b>18-12250P</b>	F03FR01607

- Solid Carbide Bits

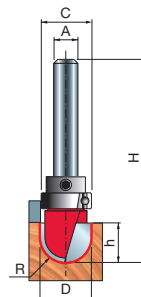

**Bits with ball bearing (not suitable for CNC machines)**

D	h	H	A	R	C	Z	Max RPM	Freud Code	Art. No.
mm	mm	mm	mm	mm	mm		1/min.		
15,88	11	59,5	6	8	15,8	2	24.000	<b>18-51006P</b>	F03FR01609
19,05	11,1	59,5	6	9,5	19	2	24.000	<b>18-51206P</b>	F03FR01611
15,88	11	59,5	8	8	15,8	2	24.000	<b>18-51008P</b>	F03FR01610
19,05	11	59,5	8	9,5	19,05	2	24.000	<b>18-51208P</b>	F03FR01612

**Wood bowl bits**

19- 99-

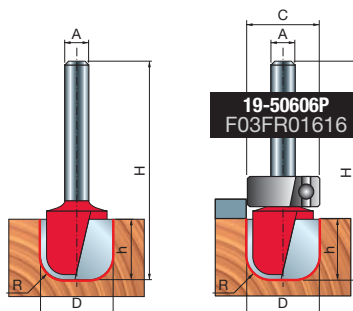
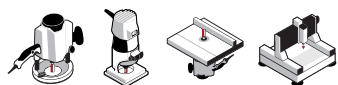

D	h	H	A	R	C	Z	Max RPM	Freud Code	Art. No.
mm	mm	mm	mm	mm	mm		1/min.		
19	15,9	64,1	6	6,35	19	2	24.000	<b>19-50606P</b>	F03FR01616
19,05	15,9	47,5	6	6,35	-	2	24.000	<b>19-10606P</b>	F03FR01613
19,05	15,9	47,5	8	6,35	-	2	24.000	<b>19-10608P</b>	F03FR01614
19,05	15,9	67	12	6,35	-	2	24.000	<b>19-12612P</b>	F03FR01615
31,75	15,8	53	12	6,35	-	2	18.000	<b>99-02612P</b>	F03FR02420

## Ovolo bits 39-

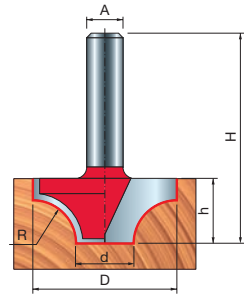
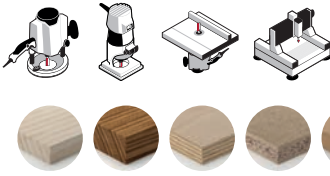

D	h	H	A	R	d	Z	Max RPM	Freud Code	Art. No.
mm	mm	mm	mm	mm	mm		1/min.		
12,7	8	40	6	3,2	6,35	2	24.000	<b>39-20206P</b>	F03FR01871
24,7	12,7	44,7	8	6	12,7	2	24.000	<b>39-20908P</b>	F03FR01873
31,75	14,3	46,3	8	9,53	12,7	2	18.000	<b>39-20808P</b>	F03FR01872
63,5	33,3	71,3	12	25,4	12,7	2	12.000	<b>39-23812P*</b>	F03FR01874

\* Not suitable for hand-held machines.

## Double cove and bead groove bits 39-

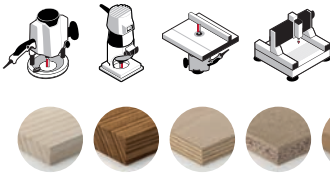

D	h	H	A	C	R1	R2	R3	Z	Max RPM	Freud Code	Art. No.
mm	mm	mm	mm	mm	mm	mm	mm		1/min.		
39,6	13	45	6	-	7,9	4,2	3,4	2	16.000	<b>39-60006P</b>	F03FR01896
39,6	13	60,1	6	39,6	7,9	4,2	3,4	2	16.000	<b>39-65006P</b>	F03FR01898
39,6	13	45	8	-	7,9	4,2	3,4	2	16.000	<b>39-60008P</b>	F03FR01897
39,6	13	60,1	8	39,6	7,9	4,2	3,4	2	16.000	<b>39-65008P</b>	F03FR01899

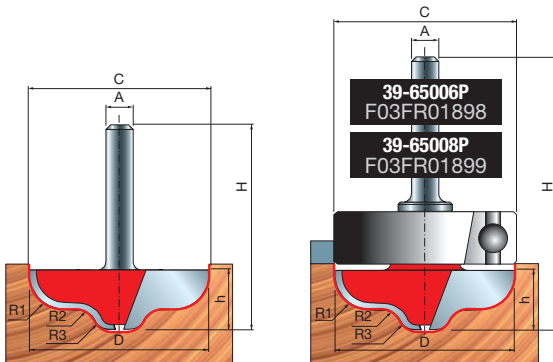

## Top bearing double cove groove bit 39-

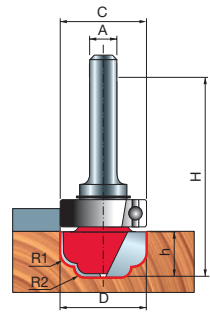

D	h	H	A	C	R1	R2	Z	Max RPM	Freud Code	Art. No.
mm	mm	mm	mm	mm	mm	mm		1/min.		
19	9,6	53	6	19	3,2	2,4	2	24.000	<b>39-51206P</b>	F03FR01887

## Cove and bead groove bits 39-

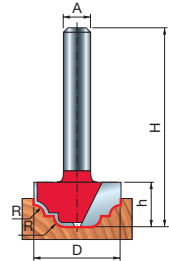
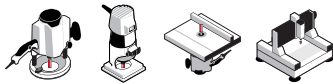

D	h	H	A	R	Z	Max RPM	Freud Code	Art. No.	
mm	mm	mm	mm	inch	mm	1/min.			
19,05	9,8	41,8	6		2,38	2	24.000	<b>39-10006P</b>	F03FR01856
25,4	12,7	44,7	6		3,18	2	24.000	<b>39-10206P</b>	F03FR01860
19,05	9,8	41,8	8		2,38	2	24.000	<b>39-10008P</b>	F03FR01857
19	12,7	44,7	8		4	2	24.000	<b>39-10108P</b>	F03FR01859
25,4	12,7	44,7	8		3,18	2	24.000	<b>39-10208P</b>	F03FR01861
31,75	12,7	44,7	8		4	2	18.000	<b>39-11408P</b>	F03FR01863
31,75	12,7	50,7	12		4	2	18.000	<b>39-11412P</b>	F03FR01864
19,05	9,8	41,8		1/4	2,38	2	24.000	<b>39-10025P</b>	F03FR01858
25,4	12,7	44,7		1/4	3,18	2	24.000	<b>39-10225P</b>	F03FR01862

## Classical beading groove bits

39-

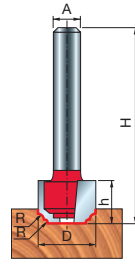
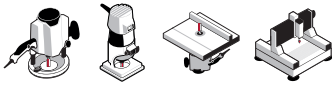

D	h	H	A	R	Z	Max RPM	Freud Code	Art. No.	
mm	mm	mm	mm	inch	mm	1/min.			
12,7	9,5	41,2	6		1,2	2	24.000	<b>39-30206P</b>	F03FR01878
15,88	9,5	41,2	6		2,38	2	24.000	<b>39-30406P</b>	F03FR01881
22,22	12	43,7	6		3,18	2	24.000	<b>39-30606P</b>	F03FR01884
12,7	9,5	41,2	8		1,2	2	24.000	<b>39-30208P</b>	F03FR01879
15,88	9,5	41,2	8		2,38	2	24.000	<b>39-30408P</b>	F03FR01882
22,22	12	43,7	8		3,2	2	24.000	<b>39-30608P</b>	F03FR01885
12,7	9,5	41,2		1/4	1,2	2	24.000	<b>39-30225P</b>	F03FR01880
15,88	9,5	41,2		1/4	2,38	2	24.000	<b>39-30425P</b>	F03FR01883
22,22	12	43,7		1/4	3,18	2	24.000	<b>39-30625P</b>	F03FR01886

## Ogee groove bits

39-

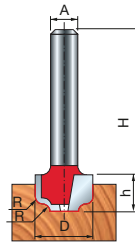
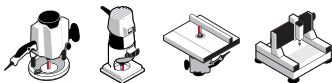

D	h	H	A	R	Z	Max RPM	Freud Code	Art. No.	
mm	mm	mm	mm	inch	mm	1/min.			
12,7	8	40	6		1,59	2	24.000	<b>39-15206P</b>	F03FR01865
19,05	12,7	44,7	6		6,35	2	24.000	<b>39-24006P</b>	F03FR01875
22,23	10,36	42,4	6		3,18	2	24.000	<b>39-15406P</b>	F03FR01868
12,7	8	40	8		1,6	2	24.000	<b>39-15208P</b>	F03FR01866
19,05	12,7	44,7	8		6,4	2	24.000	<b>39-24008P</b>	F03FR01876
22,23	10,36	42,4	8		3,2	2	24.000	<b>39-15408P</b>	F03FR01869
19,05	12,7	50,7	12		6,4	2	24.000	<b>39-24012P</b>	F03FR01877
12,7	8	40		1/4	1,59	2	24.000	<b>39-15225P</b>	F03FR01867
22,23	10,4	42,4		1/4	3,18	2	24.000	<b>39-15425P</b>	F03FR01870

## Top bearing cove and bead groove bits

39-

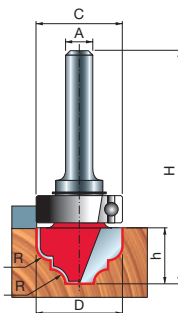

D	h	H	A	C	R	Z	Max RPM	Freud Code	Art. No.	
mm	mm	mm	mm	inch	mm	mm	1/min.			
19	12,7	55,5	6		19	3,18	2	24.000	<b>39-53206P</b>	F03FR01892
28	14	58,1	8		28	3,18	2	18.000	<b>39-53808P</b>	F03FR01894
28	14	64,1	12		28	3,18	2	18.000	<b>39-53812P</b>	F03FR01895
19	12,7	55,5	1/4		19	3,18	2	24.000	<b>39-53225P</b>	F03FR01893

## Top bearing fillet ogee groove bits

39-

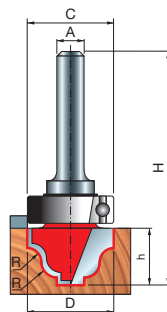

D	h	H	A	C	R	Z	Max RPM	Freud Code	Art. No.	
mm	mm	mm	mm	inch	mm	mm	1/min.			
19	12,5	55,5	6		19	3,18	2	24.000	<b>39-52206P</b>	F03FR01888
28	14,4	58,1	8		28	4	2	18.000	<b>39-52808P</b>	F03FR01890
28	14,4	64,1	12		28	4	2	18.000	<b>39-52812P</b>	F03FR01891
19	12,5	55,5	1/4		19	3,18	2	24.000	<b>39-52225P</b>	F03FR01889



## MIXED SETS

### Mixed sets

88- 90- 91- 92-

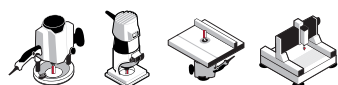

	A	Freud Code	Art. No.
	mm		
Basic 4 router bit set	6	<b>88-10606P</b>	F03FR02255
Starter 6 router bit set	8	<b>91-10408P</b>	F03FR02293
Starter 6 router bit set	12	<b>91-10412P</b>	F03FR02294
Intermediate 9 router bit set	6	<b>88-10206P</b>	F03FR02250
Super 13 router bit set	8	<b>91-10008P</b>	F03FR02275
Super 13 router bit set	12	<b>91-10012P</b>	F03FR02277
Advanced 15 router bit set	6	<b>90-10006P</b>	F03FR02256
Professional 26 router bit set	6	<b>92-10006P</b>	F03FR02308



# Cabinet door set 3 router bits

## 97-

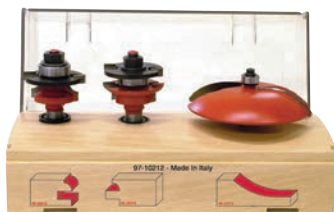

	A	Freud Code	Art. No.
	mm		
Raised panel bit + Matched profile and scribe bits	12	<b>97-10212P</b>	F03FR02382

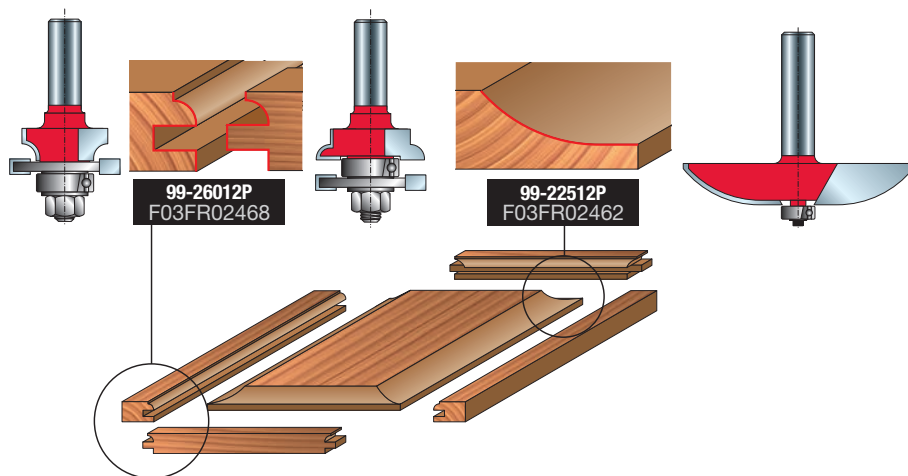

	A	Freud Code	Art. No.
	mm		
Raised panel bit + Matched profile and scribe bits	12	<b>97-10412P</b>	F03FR02396

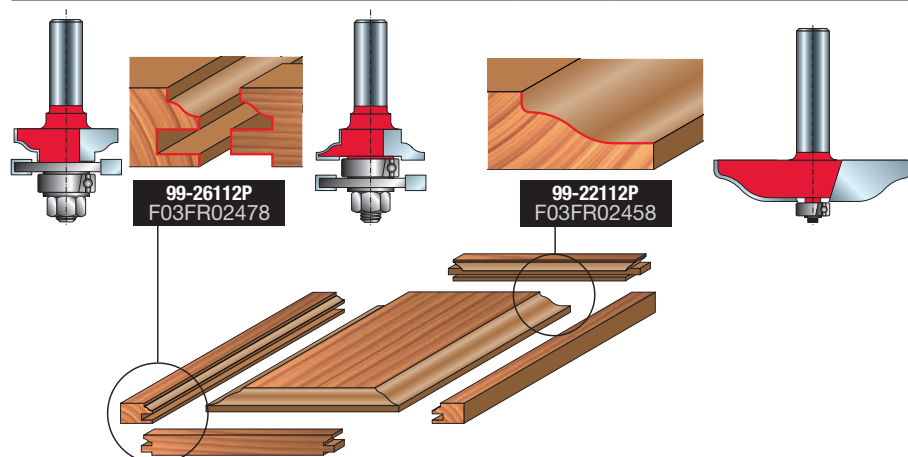

# Cabinet door set 4 router bits

95-

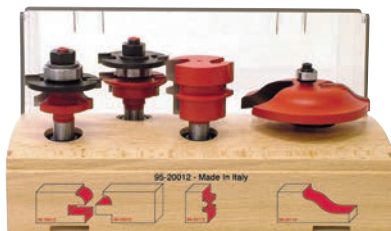

	A	Freud Code	Art. No.
	mm		
Raised panel bit + Matched profile and scribe bits + Reversible glue joint bit	12	95-20012P	F03FR02368

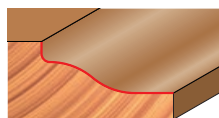
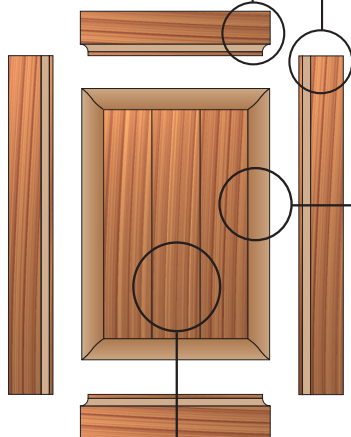

**99-22112P**  
F03FR02458

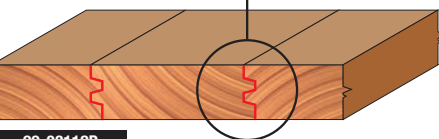
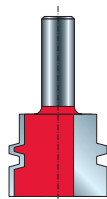
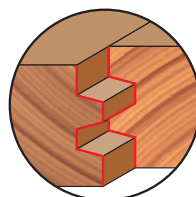
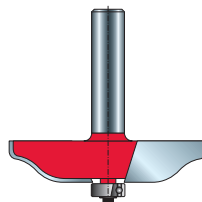

**99-03112P**  
F03FR02422

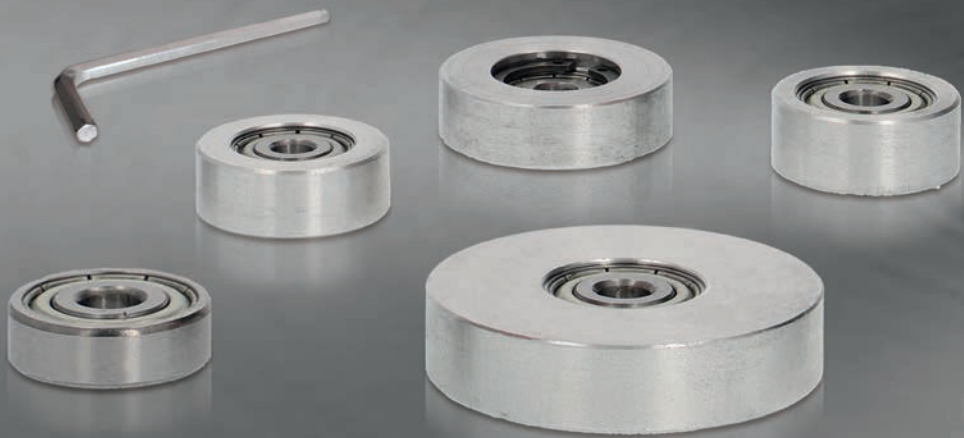

## ACCESSORIES

### Reducing bushes 3105M

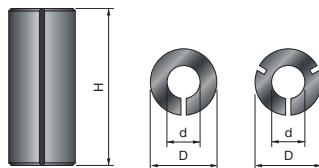

D	H	d	Freud Code	Art. No.
mm	mm	mm		
8	25	6	<b>3105MUY250</b>	F03FA10588
8	25	6,35	<b>3105MVX250</b>	F03FA10587
9,5	25	6	<b>3105MUY250</b>	F03FA10586
9,5	25	6,35	<b>3105MUX250</b>	F03FA10585
9,5	25	8	<b>3105MUV250</b>	F03FA10584
10	25	8	<b>3105MTV250</b>	F03FA10582
12	25	6	<b>3105MSY250</b>	F03FA10581
12	25	8	<b>3105MSV250</b>	F03FA10580
12	25	10	<b>3105MST250</b>	F03FA10579
12,7	25	6	<b>3105MRY250</b>	F03FA10578
12,7	25	6,35	<b>3105MRX250</b>	F03FA10577
12,7	25	8	<b>3105MRV250</b>	F03FA10576
12,7	25	9,53	<b>3105MRU250</b>	F03FA10575
16	25	13	<b>3105MOQ250</b>	F03FA10574

## Ball bearings 3102M

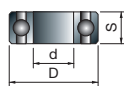

D	S	d	Freud Code	Art. No.
mm	mm	mm		
9,53	3,2	4,76	<b>3102M AA9</b>	F03F010006
12	4	6,05	<b>3102M BB9</b>	F03FA10568
12,7	4,98	4,76	<b>3102M AB9</b>	F03F010007
13	5	4	<b>3102M CD9</b>	F03FA14096
13	5	6	<b>3102M AP9</b>	F03FA10558
14	4	8,05	<b>3102M BC9</b>	F03FA10569
15	5	6	<b>3102M AQ9</b>	F03FA10559
15,88	4,98	4,76	<b>3102M AJ9</b>	F03F010014
16	5	5	<b>3102M CC9</b>	F03FA14095
16	5	8	<b>3102M AS9</b>	F03FA10561
19	6	6	<b>3102M CA9</b>	F03FA14097
19	7	10	<b>3102M AG9</b>	F03F010012
19,05	3,97	12,7	<b>3102M CB9</b>	F03FA14098
19,05	6,35	12,7	<b>3102M AV9</b>	F03F012286
22	7	8	<b>3102M AC9</b>	F03F010008
28	8	12	<b>3102M AH9</b>	F03F010013
32	9	15	<b>3102M AN9</b>	F03F010016
35	11	15	<b>3102M AI9</b>	F03F012285

## Ball bearing rub collars RB62M

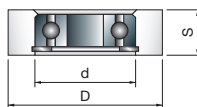

D	S	d	Freud Code	Art. No.
mm	mm	mm		
19,05	8	4,76	<b>RB62M 1509</b>	F03F011422
22,22	8	4,76	<b>RB62M 1529</b>	F03F011423
26	10	8	<b>RB62M 1249</b>	F03F011417
28,58	8	4,76	<b>RB62M 1549</b>	F03F011424
30	10	8	<b>RB62M 1289</b>	F03F011418
34	10	8	<b>RB62ME DA9</b>	F03FR01146
34,92	8	4,76	<b>RB62M 1569</b>	F03F011425
39,6	11,2	12	<b>RB62ME FB9</b>	F03FR01147

## Sleeved bearings with angle 2103MC

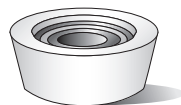
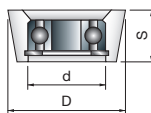

D	S	d	$\alpha$	Freud Code	Art. No.
mm	mm	mm			
19,05	6,35	4,8	10°	<b>3103MC HB9</b>	F03F010019
22,2	9	12,7	15°	<b>3103MC HC9</b>	F03FR01724

# CORRECT USE AND SAFETY RULES

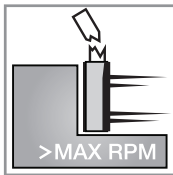

Do not exceed the maximum RPM marked on the bit. Higher speeds, extreme feeds and excessive depth of cut may cause tool breakage.

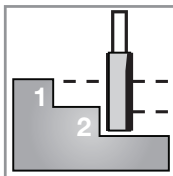

For large amounts of material to be removed, carry out more passes or work at a feed rate and speed in proportion to the depth of cut.

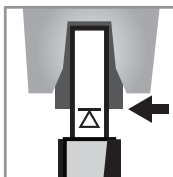

Respect the minimum insertion marking of the shank.



Securely fix the workpiece to the worktable.

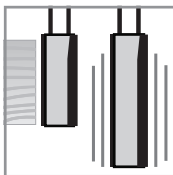

Always choose router bits with the right dimensions for the job. A shorter cutter will vibrate less than a longer cutter of the same diameter.

# CORRECT USE AND SAFETY RULES

## Feed Direction Rules

### Portable routing



### Table routing

For table routing, feed the woodpiece against the sense of rotation of the bit.



## Problem solving

Problem	Decrease ▼	Increase ▲
Burn marks	Rotation speed	Feed speed
Tear out	Feed speed	Rotation speed
Vibrations	Rotation speed Cutting depth	Bit insert depth in collet Fixation of workpiece
Cutter breakage	Feed speed Cutting depth	Shank diameter

# Precisely the best

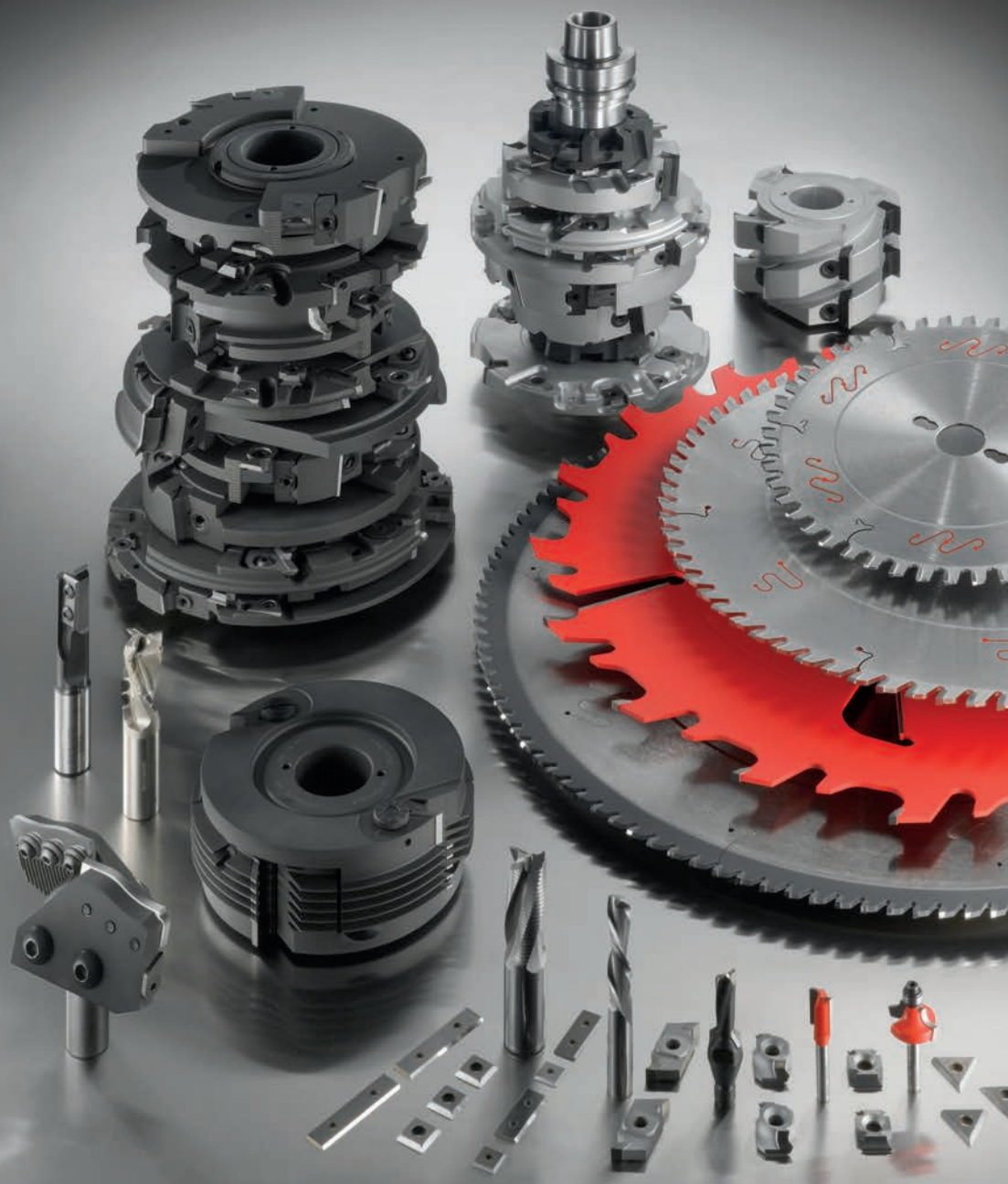





## **Freud - Leading the industrial market since 1962**

Freud is a worldwide leader in the cutting tool industry and the biggest manufacturer of premium circular saw blades. Since 1962 Freud designs and produces an extensive range of superior quality circular saw blades, cutter heads & brazed cutters, drilling, routing & CNC tools as well as knives and accessories.

### **Freud technologies and solutions Perfection crafted for your needs**

Freud premium quality cutting tools are produced with unique and innovative features. The company owns and controls the entire tool manufacturing process, with a full and strict monitoring over quality, across its plants in Italy. The continuous investment in Research & Development, combined with Freud strong engineering competence and advanced technologies, results in products with innovative features, extreme precision and extended lifetime. Always the right solution for your application needs.



### **Technological supremacy In-house Carbide production**

Leader in Carbide manufacturing since 1980: Freud prides itself of a unique in-house production and sintering of Carbide components, for superior quality cutting tools. Freud TiCo, a specially formulated, highly compact combination of Titanium and Cobalt Carbide, ensures maximum precision and long lasting sharpness of the cutting edge. The ability to formulate dedicated recipes, for standard and customised applications, delivers the highest tool performance.

### **Global distribution Worldwide services wherever you are**

Freud's belief in "think global and act local" has led the company to develop an extensive network of selected partners and subsidiaries, in over 90 countries worldwide. This to better support their customers wherever they are.

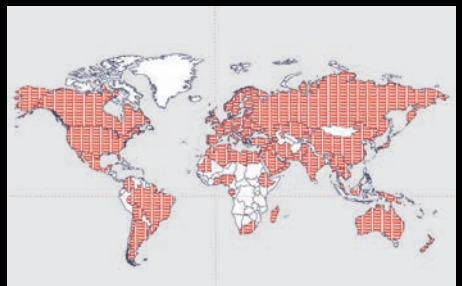



# freud

---

**Freud UK**

Broadwater Park  
North Orbital Rd  
Denham  
UB9 5HJ  
UK

[www.freudtools.co.uk](http://www.freudtools.co.uk)



MKFRM 236 - F03FA23939 Printed in Italy - July 2023 - Rev. 0